



# ALTROZ BS VI

## OWNER'S MANUAL



**TATA MOTORS**

Rev03 / Nov 21

## CUSTOMER ASSISTANCE

---

In our constant endeavour to provide assistance and complete service backup, TATA MOTORS has established an all India customer assistance centre.

In case you have a query regarding any aspect of your vehicle, our Customer Assistance Centre will be glad to assist you on our Toll Free no. **1800 209 8282**

You can also approach nearest TATA MOTORS dealer.

A separate Dealer network address booklet is provided with the Owner's manual.

TATA MOTORS 24X7 Roadside Assistance Program offers technical help in the event of a breakdown. Call the toll-free Roadside Assistance.

For additional information, refer to "**24X7 Roadside Assistance**" section in the Owner's manual.



**Dear Customer,**

Welcome to the TATA MOTORS family.

We congratulate you on the purchase of your new vehicle and are privileged to have you as our valued customer.

We urge you to read this Owner's Manual carefully and familiarize yourself with the equipment descriptions and operating instructions before driving.

Always carry out prescribed service / maintenance work as well as any required repairs at an authorized TATA MOTORS Dealers or Authorized Service Centre's (TASCs). Use only genuine parts for continued reliability, safety and performance of your vehicle.

You are welcome to contact our dealer or Customer Assistance toll free no. **(1800 209 8282)** in case of any query or support required.

We wish you a safe and pleasant driving experience.

**TATA MOTORS**

Bombay House, 24, Homi Modi Street,  
Hutatma Chowk, Fort, Mumbai – 400001

## **IMPORTANT INFORMATION**

---

- Before driving, read this Owner's manual carefully and familiarize yourself with your vehicle. For your own safety and a longer vehicle life, follow the instructions, 'Warnings' and 'Notes' in this manual. Ignoring them could result in damage to the or personal injury to you or others.
- The Owner's manual and other booklets are important documents and should always be kept in the vehicle. If you sell the vehicle, always pass on the documents to the new owner.
- This Owner's Manual describes all variants of the model and all standard/optional equipment of your vehicle available at the time of printing. Please note that your vehicle may not be equipped with all features described.
- TATA MOTORS PASSENGER VEHICLES LIMITED reserves the right to introduce changes in the design, equipment and technical features without any obligation to install them on the vehicles previously sold. The equipment in your vehicle may therefore differ from that shown in the descriptions and illustrations.
- Do not carry out any modification including fitment of non-genuine accessories on your vehicle. Safety, handling, performance and durability, may otherwise be adversely affected and may violate government regulations. TATA MOTORS PASSENGER VEHICLES LIMITED no liability for damage resulting from the modifications or use of non-genuine accessories.
- All rights reserved. The information in this manual shall not be copied, translated or otherwise reproduced, in whole or in part without written permission from TATA MOTORS.

© Copyright 2021 TATA MOTORS

**01. SAFETY**

Important Information	1
Seat Belts	3
Child Restraint System (CRS)	7
Supplementary Restraint System (SRS) (airbags) (if equipped)	12
Child Lock (if equipped)	17
Anti-theft Device Immobilizer / PEPS	19
Anti-lock Braking System (ABS)	20
Electronic Brake Force Distribution (EBD)	21
Brake Sway Control (BSC)	21

**02. OPENING AND CLOSING**

Keys	23
Doors	25
Smart Key Features	26
Windows	28
Tail Gate Opening	31
Fuel Lid	32

**03. DASHBOARD AND FEATURES**

Cockpit	35
Instrument Cluster (TFTScreen) (as applicable)	36
Instrument Cluster (LCDScreen)	52
Tell Tales	65
Audio Reminder (as available)	72
Combi Switch (RH Stalk) (if available)	73
Head Lamp Leveling Rotary Switch	74
Combi-switch (LH Stalk) (if available)	74
Dashboard Controls	76
Steering Mounted Controls (LHS) (if available)	77
Steering Mounted Controls (RHS) (if available)	78
Mic	79
Infotainment System Display (if available)	80
Speakers & Tweeter (if available)	81
Usb Port (if available)	81
Power Socket	82
Antenna	82
Roof Grab Handle	83
Roof Lamp	83

## CONTENTS

Boot Lamp (if available)	84
Side Indicator Lamp	85
Front Lamp	85
Tail Lamp	85
Ambient Lights (if available)	86
Ira (intelligent Real-time Assist) Connected Car Service	86
Indirect Tire Pressure Monitoring System (if equipped)	87

### 04. STOWAGE COMPARTMENT

Stowage Compartment	93
Goggle Stowage	97
Hooks (if available)	98

### 05. CLIMATE CONTROL

Air Distribution	99
Air Vent	100
Rear Ac Vents (if available)	100
Hvac Controls (if available)	101

Electronic Temperature Control (etc) (if available)	105
Fully Automatic Temperature Control (fatc) (if available)	107

### 06. STARTING AND DRIVING

Pre Driving Checks	115
Driving Tips	116
Seat Adjustments	119
Rear View Mirrors	122
Orvm Folding (as applicable)	123
Sun Visors (if available)	124
Electric Power Assisted Steering (epas)	124
Steering Wheel Adjustment	125
Steering Lock And Ignition Switch (if available)	126
Starting And Stopping (without Peps)	127
Starting And Stopping (peps) (if available)	128
Engine Passive Start - Conditions	129
Engine Passive Stop - Conditions	130
Pess-wearable Key (if available)	131

Gear Shifting	134	Jump Starting Your Car	165
Reverse Gear	134	Towing	167
Driving	135	Fuses	169
Starting the Engine	135	Bulb Specification	177
Braking	136	24 X 7 Road Assistance	180
Drive Mode (as available)	137		
Center Lock Unlock (as available)	138	<b>08. MAINTENANCE</b>	
Current Gear Indication	138	Maintenance And Service	183
Gear Recommendation	138	Engine Compartment - Diesel	184
Idle Stop Start (iss) (if available)	139	Engine Compartment- Petrol (na Engine)	185
Parking Brake	143	Engine Compartment - Petrol (tc Engine)	186
Vehicle Parking	144	Engine Oil Level	187
Reverse Park Assist With Sensor (if available)	144	Brake Fluid Level	188
Rear View Camera (if available)	147	Engine Coolant Level	189
		Windshield Washer Fluid Level	190
<b>07. EMERGENCY AND BREAKDOWN ASSISTANCE</b>		Battery	191
Emergency Equipment	153	Spark Plug (petrol)	192
Spare Wheel Removal Process	154	Tyres	193
In Case Of Flat Tyre	155	Smart Key Battery Replacement (for PEPS variant)	196
Puncture Repair Kit (if available)	158		

## CONTENTS

Wearable Key Battery Replacement Procedure	196
On Board Diagnostic (OBD II) System	197
Service Instructions	199
Service Schedule	200
Vehicle Parking For Long Duration (non-use Maintenance)	206

### 09. TECHNICAL INFORMATION

Fuel Specification	207
Lubricant Specification	208
Technical Information	209
Vehicle Dimensions	212
Aggregate Identification Numbers	213

### 10. VEHICLE CARE AND VALUE ADDED SERVICES

Car Care	215
Fast Tag	217
Value Care - Amc	218
Extended Warranty	222
Value Added Services	224

Vehicle Exterior Enrichment	226
Vehicle Interior Enrichment	227

### 11. WARRANTY -TERMS AND CONDITIONS

Warranty - Terms And Conditions	229
---------------------------------	-----

### 12. ENVIRONMENT SAFETY

Environment Safety	231
Emission Affected Components	232



**IMPORTANT INFORMATION**

In this Owner's Manual, you will find the text under the heading "WARNING" and "NOTE" which highlights important information. Pay particular attention to these highlighted messages.

** NOTE**

*Indicates additional information that will assist you in gaining the optimum benefit and care for your vehicle.*

** WARNING**

Indicates procedures or information that must be followed precisely in order to avoid the possibility of severe personal injury and serious damage to the vehicle.

**Safe Driving**

Safety consciousness not only ensures your safety and the safety of other road users, but it also helps to reduce the wear and tear on your vehicle.

**Safe driving depends on:**

- How quickly you make decisions to avoid an accident.
- Your ability to concentrate.
- How well you can see and judge objects.
- How well familiar you are with your vehicle controls and its capabilities

** NOTE**

*Fatigue is a result of physical or mental exertion that impairs judgment. Driver fatigue may be due to inadequate sleep, extended work hours, strenuous work or non-work activities or combination of other factors. Take rest at regular intervals.*

**Safety Tips**

- Always take into account the road conditions, weather conditions, vehicle speed in order to prevent accidents.
- Turn 'ON' the side indicators at least 30 meters before taking a turn or changing the lane.
- Decelerate to a safe speed before tak-

ing turn. Do not apply brakes during cornering.

- When overtaking other vehicles, watch out for the oncoming vehicle.
- Never drive under the influence of alcohol or drugs.
- If your vehicle is equipped with infotainment/navigation system, set and make changes to your travel route only when the vehicle is parked.
- Program radio presets with the vehicle parked, and use your programmed presets to make radio use quicker and simpler.

## SAFETY

### Driving Through Water

Do not drive through flooded areas. Judge the depth of water before driving through it. Otherwise, water may enter the vehicle interior or the engine compartment.

If at all the situation demands that you have to drive through water then;

- Keep engine in higher RPM and crawl the vehicle in low gear.
- Flowing or rushing water creates strong forces. Driving through flowing water could cause the vehicle to about trying to drive through flowing water.
- Lightly apply the brake pedal to dry the liners until the brakes work normally once you are out of water.

#### WARNING

Do not attempt to start the engine if vehicle gets flooded due to water. Tow the vehicle to a safe place. Contact a nearest TATA MOTORS Authorised Service Centre

### Driving on a Rainy Day

- Check wiper blades, lights and brakes for proper functioning and condition.
- Check the tyre treads depth, the condition of the tread and tyre.
- Avoid harsh braking and sharp turns. It may cause loss of control and lead to a skid.
- For slowing down, shift to lower gears and brake gently.
- Keep lights 'ON' if visibility is poor.

### Driving on Wet Roads

On wet road or during light showers, "Aquaplaning" can occur. "Aquaplaning" is the loss of direct contact between the road surface and the vehicle's tires due to a water film forming between them. Steering or braking the vehicle can be very difficult, and loss of control can occur. There is no hard and fast rule about aquaplaning. The best advice is to slow down when the road is wet.

#### NOTE

*If you have driven for a long time in heavy rain without braking, there may be a delayed reaction from the brakes when braking for the first time. You have to press the brake pedal more firmly. Maintain a greater distance from the vehicle in front.*

### Night Driving

- Ensure that all lights are working and windshield, window glasses are clean.
- Drive more slowly at night than in the daytime, as the visual range is restricted at night. Maintain a speed such that you can stop within illuminated distance of head lamps.
- Do not use the high beam unless inevitable. It may dazzle the driver of the oncoming vehicle, thus causing an accident.
- Use head lamp main/dip beam to alert other road users on turns/ cross roads.
- Use side indicators for lane change or turning.

### Driving on Gradients

When climbing gradient, the vehicle may begin to slow down and show a lack of power. If this happens, shift to a lower gear and apply power smoothly so that there is no loss of traction. When driving down a hill, the engine braking should be used by shifting into a lower gear. Do not drive in neutral gear or switch off the engine.

#### WARNING

On long and steep gradients you must reduce the load on the brakes by shifting early to a lower gear. This allows you to take advantage of the engine braking effect and helps avoid overheating of service brakes resulting in reduced braking efficiency.

### Driving on Highway

Stopping distance progressively, increases with vehicle speed. Maintain a sufficient distance between your vehicle and the vehicle ahead.

For long distance driving, perform safety checks before starting a trip and take rest at certain intervals to prevent fatigue.

### SEAT BELTS

This section of user manual describes your vehicle's seat belt, airbag and Child restraints system. Please read and follow all these instructions carefully to minimise risk of severe injury or death.

- Seat belts are the primary restraints system in the vehicle. All occupants, including the driver, should always wear their seat belts to minimize the risk of injury.
- Sit back and adjust the front seat. Make sure that your seat is adjusted to a good driving position and the back of the seat is upright.

#### Buckling the Shoulder Seat Belt

- Grasp the tongue then slowly pull out the seat belt over the shoulder and across the chest. When the seat belt is long enough to fit, insert the tongue into the lock buckle until you hear a "CLICK" which indicates that the seat belt is securely locked.
- Position the lap portion of seat belt across your thighs, below your ab-

## SAFETY

domen. To remove slack, pull up a bit on the shoulder seat belt. To loosen the lap portion seat belt if it is too tight, tilt the tongue and pull on the lap seat belt. A snug seat belt reduces the risk of sliding under the seat belt in a collision. Ensure that the seat belt running over the body (shoulder segment and lap segment) does not have any twist. Twisted seat belt may not offer effective protection when required.

### Releasing the Seat Belt

To release the seat belt, push the red button on the lock buckle. The seat belt will automatically retract to its stowed position. If necessary, slide the tongue down the webbing to allow the seat belt to retract fully.



#### **i** NOTE

*The above image is for reference purpose only.*

### Fixed Rear Centre Lap Seat Belt

When buckling, make sure you hear a click confirming that the tab is latched into the seat belt lock. To tighten it, pull the loose end through the buckle until the seat belt is comfortably adjusted around the hips.

### Seat Belt Height Adjustments (if applicable)

If height adjustment is provided in the seat belt, occupant can adjust it to their comfort, as may be applicable.

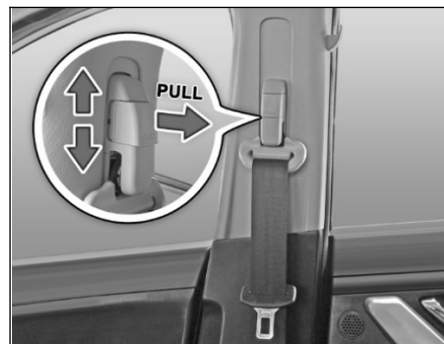

** NOTE**

*The above image is for reference purpose only.*

** WARNING**

- Each seating position and seat belt assembly must only be used by one occupant. It is not recommended to put a seat belt around a child, being carried on an occupant's lap.
- Be careful not to damage or tamper the seat belt webbing or hardware. Inspect the seat belt system periodically, checking for cuts, frays, or loose parts. A frayed or torn seat belt could rip apart in a collision and leave you with no protection.
- If the seat belt webbing or hardware is damaged, get it replaced immediately at TATA Motors Authorized service centre.
- Do not insert any items such as coins, clips, etc. into the seat belt buckles, and be careful not to spill

liquids into these parts. If foreign materials get into a seat belt buckle, the seat belt will not work properly.

- Do not wear seat belts over hard, sharp or fragile items in clothing, such as pens, keys, spectacles etc.
- Do not use any accessories on seat belts or modify in any way the seat belt system. Devices claiming to improve occupant comfort or reposition the seat belt can reduce the protection provided by the seat belt and increase the chance of serious injury in a collision.

**Seat Belts with Pre-tensioner (if equipped)**

You can use the pre-tensioner seat belts in the same manner as ordinary seat belts. The seat belt pre-tensioner system works in conjunction with the SUPPLEMENTARY RESTRAINTS SYSTEM (SRS-Airbags). In the event of a collision, as may be necessary, pre-tensioner tightens the seat belt so that it fits the occupant's body more snugly. When pre-tensioner activates, there could be some noise and release of smoke. This is normal and there are no health hazards or fire risk.

** WARNING**

In a collision, the pre-tensioner seat belt assembly mechanisms becomes hot during activation. Do not touch the pre-tensioner seat belt assemblies for several minutes after they have been activated.

If the vehicle has been involved in a collision, get it inspected immediately at authorized TATA MOTORS SERVICE Center.

## SAFETY

### Seat Belts With Load Limiter (if equipped)

You can use the load limiter seat belts in the same manner as ordinary seat belts. The seat belt load limiter system works in conjunction with the SUPPLEMENTARY RESTRAINTS SYSTEM (SRS-Airbags). In the event of a collision, as may be necessary, load limiter reduces the load on the rib cage region of the occupant. If the vehicle has been involved in a collision, get it inspected immediately at Authorised TATA MOTORS SERVICE Center.

### Use of Seat Belts for Pregnant Woman

#### WARNING

- Pregnant woman must wear a correctly positioned seat belt. It is safer for mother as well as unborn child.
- Pregnant woman should wear the lap part of the seat belt across the thighs and as snug across the hips as possible. Keep the seat belt low so that it does not come across the abdomen. That way the strong bones of the hips will take the force if there is a collision.



### Seat Belt Warning Lamp



For Driver



For Front seat  
passenger

The seat belt warning lamp reminds you to fasten the seat belt.

- If the driver does not fasten seat belt, seat belt reminder lamp will blink and a buzzer will sound for predefined duration until the driver seat belt is buckled.
- If front passenger seat is occupied by adult and does not fasten seat belt, seat belt reminder lamp will blink and a buzzer will sound for predefined duration until the front passenger seat belt is buckled.
- If this system is also provided for other than Front row seats, applicable above warning will appear until seat belts are buckled.
- If front passenger seat is occupied by

child, system may detect occupancy and warn with front passenger seat belt warning. It is not taken to mean child can occupy front passenger seat and use seat belt. Please refer CRS section for recommended seating position.

### **i NOTE**

*Using unauthorized after-market seat cover may affect function of occupant sensor. TATA MOTORS does not recommend any non-validated seat cover on seats.*

## **CHILD RESTRAINT SYSTEM (CRS)**

TATA MOTORS strongly recommends the use of Child Restraint Systems (CRS) for all children up to age of 12 years and to be placed at recommended positions only. Children travelling without recommended CRS and seated at other positions may face serious injuries in case of a collision.

CRS can be installed in the vehicle using seat belts and/or ISOFIX only (if equipped) or ISOFIX with Top Tether (if equipped).

The harness system of CRS holds the child in place, and in a collision, acts to keep the child positioned in the seat and reduce the risk of injuries.

All children below age of one year must always ride in a rear-facing infant CRS.

Keep children in a forward-facing CRS with a harness until they reach the size or weight limit allowed by your CRS manufacturer.

Once your child outgrows the forward-facing CRS, your child is ready for a booster seat.

## **Selection and Installation of CRS**

Always select the CRS that complies with latest safety standards (AIS072 / ECE R44). The CRS are classified according to the child's size, height and weight. Select the appropriate CRS for your child. Ensure that the child fits properly in the CRS and it is securely installed in the vehicle. For installation, please refer CRS manufacturer's instruction manual.

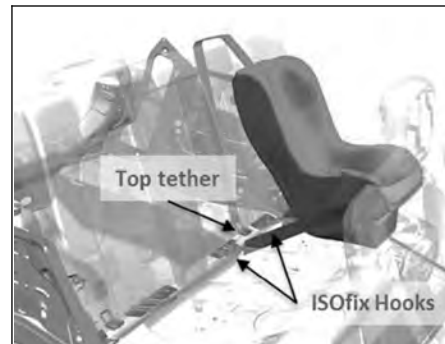

## SAFETY

---

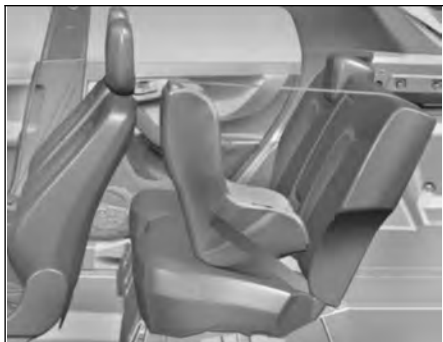

### ***i*** NOTE

*The above images are for reference purpose only.*



### Recommended CRS Position as per the Vehicle Matrix

The suitability of seat position for carriage of children and recommended category of CRS is shown in the table below as per the child group.

X - Seat Position not suitable for children in this age group.

U - Suitable for “universal” category restraints approved for use in this age group.

Universal is a category in the AIS072 / ECE R44 norm.

#### WARNING

If a child is seated in the front seat it may cause serious injury or even death during any collision.

Group	Mass Group	Age Group	Front Passenger	Rear Out-board Lh	Rear Out-board Rh	Rear Center
0	Up to 10 kg	Up to 9 months	X	U	U	X
0+	Up to 13 kg	Up to 24 months	X	U	U	X
I	9 to 18 kg	9 months to 48 months	X	U	U	X
II	15 to 25 kg	Approx. 3 to 7 years	X	U	U	X
III	22 to 36 kg	Approx. 6 to 12 years	X	U	U	X

## SAFETY

### WARNING

If your vehicle is equipped with a front passenger Airbag (PAB) and does not have PAB deactivation switch, do not install a rear-facing CRS in the front passenger seat. If the PAB inflates, a child in a rear facing CRS could be seriously injured or killed.

If you install a CRS in the rear seat, slide the front seat far enough forward so that the child's feet do not touch the front seat-back. This will help avoid injury to the child in the event of a collision.

### NOTE

*Children could be endangered in a collision if their CRS is not properly secured in the vehicle. Be sure to secure the child in the restraint system according to the manufacturer's instructions.*

### WARNING

Do not use an infant carrier or a child safety seat that "hooks" over a seat-back, it will not provide adequate protection in a collision.

After a collision, we recommend to get seat belts, seats, ISOFIX and top-tether anchorages (as may be applicable) investigated at TATA MOTORS Authorised service centre.

### NOTE

*CRS in a closed vehicle can become very hot. To prevent burns, check the seating surface and buckles before placing your child in CRS.*

### WARNING

- Do not leave unattended children in your vehicle.
- Do not modify CRS in any way.

### NOTE

- *Do not install a booster seat or a booster cushion with only the lap strap of the seat belt.*
- *Do not install a booster seat or a booster cushion with a seat belt that is slack or twisted.*
- *Do not put the safety seat belt under your child's arm or behind its back.*
- *Do not use pillows, books or towels to boost your child's height.*
- *Make sure that your children sit in an upright position.*
- *Do not allow children to stand up or kneel on either the rear or the front seats. An unrestrained child could suffer serious or fatal injuries during a collision.*
- *Do not leave any toys or other objects loose in the CRS or on the seat while the vehicle is in motion.*

Each CRS should be used for one child only.

If the airbag SRS warning indicator in the instrument cluster illuminates continuously, it means that there is malfunction in the system. Remove the CRS from front passenger seat and contact your TATA MOTORS authorised service center.

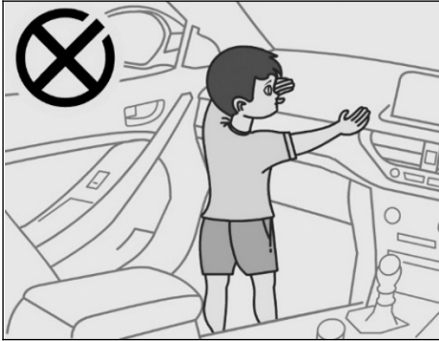
**NOTE**

The above images are for reference purpose only.

## SAFETY

### SUPPLEMENTARY RESTRAINT SYSTEM (SRS) (AIRBAGS) (if equipped)

The airbag 'SRS' system comprises of the following components depending upon the provided safety features in your vehicle.

- Seat belt Pre-tensioners..
- Seat belt with load limiters.
- Driver Airbag.
- Front Passenger Airbag.
- Airbag 'SRS' ECU (Electronic Control Unit).
- Collision Sensors.
- SRS wiring harness.
- SRS Warning lamp

The System is active when ignition switch is in the "ON" position or the ignition mode is "ON".

Airbags are designed to inflate in collisions when required. In the event of a collision, the collision sensors will detect signals, and if the Airbag ECU judges that the signals represent a severe collision, will trigger the airbags. The inflated Airbags

provide a cushion to the occupants. The Airbag inflates and deflates so quickly that you may not even realize that it has activated. The Airbag will neither hinder your view nor make it harder to exit the vehicle.

Airbag inflation is virtually instantaneous and occurs with considerable force, accompanied by loud noise and smoke, which is normal. The inflated airbag, together with seat belts, limit the movement of an occupant, thereby reducing the risk of injury.

When an airbag inflates, you may see some smoke-like particles. The particles are a normal by-product of the process that generates the non-toxic gas used for airbag inflation. These airborne particles may irritate the skin, eyes, nose, or throat. If you have skin or eye irritation, rinse the area with water. For nose or throat irritation, move to fresh air. Also sometimes the smoke can cause breathing problems. In such cases, it is recommended to get fresh air promptly.

After inflation, airbag provides a gradual cushioning effect for the occupant there-

after deflates. It is not advisable to drive your vehicle after the airbags have been deployed. If you are involved in another collision, the airbags will not be in place to protect you.

#### **i** NOTE

*The below image is for reference purpose only.*



**i NOTE**

- *Open your windows and doors as soon as possible after collision to reduce prolonged exposure to the smoke and powder released by the inflating Airbag.*
- *Do not touch the Airbag container's internal components immediately after an Airbag has inflated. The parts that come into contact with an inflating Airbag may be very hot.*
- *Always wash exposed skin areas thoroughly with lukewarm water and mild soap.*

The driver airbag is mounted in the centre of the steering wheel. The front passenger airbag is located inside the dashboard in front of the passenger seat. The vehicle fitted with the airbags have suitable indications on steering wheel and on dashboard. The word 'AIRBAG' is embossed on the airbag covers.

**⚠ WARNING**

- Even in vehicles with Airbags, you and your passengers must always wear the seat belts provided. In order to minimize the risk and severity of injury in the event of a collision.
- ALWAYS use seat belts and CRS – during every trip and at all times. Even with airbags, you can be seriously injured or killed in a collision if you are not wearing seat belt properly or not wearing seat belt when airbag inflates.
- You and your passengers should never sit or lean unnecessarily close to the Airbags.
- Move your seat as far back as possible from front Airbags, while still maintaining control of the vehicle.
- All occupants should sit upright with the seatback in an upright position, centred on the seat cushion with their seat belt on, legs comfortably extended and their feet on the floor until the vehicle is parked and the

engine is turned off.

- If an occupant is out of position during collision, the rapidly deploying Airbag may forcefully contact the occupant causing serious or fatal injuries.
- Do not allow the front passenger to place their feet or legs on the dashboard.

**Not Recommended Seating Position**

## SAFETY



### **i** NOTE

*The above images are for reference purpose only.*

### **⚠** WARNING

- Never place your arm over the airbag as a deploying airbag can result in serious arm fractures or other injuries.
- Do not place or stick any item/s in the vehicle, except at designated locations (such as utility bins, cup/bot

tle holders, Boot space etc). Loose items may act as a projectile during a collision and cause severe to fatal injuries.

- Please be aware that any unsecured item in your vehicle, such as your pet, unsecured CRS or a lap-top, can become a potential hazard in the event of a collision or sudden stop, causing injuries to occupants in the vehicle.
- Coat hooks (if provided), must be used only for that purpose. Never hang heavy items on to those hooks. This may lead to severe to fatal injuries.
- ALWAYS contact your TATA MOTORS authorised service centre if the vehicle is damaged, even if airbag has not inflated.
- ALWAYS contact your TATA MOTORS authorised service centre if any part of an airbag module cover shows sign of cracking or damage.

### WARNING

If your SRS malfunctions, the Airbag may not inflate properly during a collision thereby increasing risk of serious injury or death. If any of the following conditions occur, your SRS is malfunctioning:

- The SRS warning lamp does not turn 'ON' when the ignition switch is placed in the 'ON' position for few seconds.
- The SRS warning lamp stays 'ON' after illuminating
- The SRS warning lamp comes 'ON'/stays 'ON' while the vehicle is in motion.
- The SRS warning lamp blinks when the engine is running.

We recommend the customer to immediately visit TATA MOTORS authorised service centre and get the SRS system inspected if any of the above conditions occur.

### WARNING

- Never make any modifications to your vehicle. The modifications carried out, but not limited to the vehicle frame, bumpers, front fenders, ride height, suspension, seat belts, interior trims, steering wheel (especially holders), are not acceptable. This will affect the intended performance of SRS system.
- Fitment of bull bars is strictly prohibited, unless authorised by TATA MOTORS. This will affect the intended performance of SRS system.
- If you need to make any modifications to accommodate any disability you may have, please contact your Authorized TATA MOTORS Dealer for necessary guidance.
- Do not tamper with SRS in any way. This will lead to unexpected performance of system and may cause serious injury or death.

## SAFETY

### Airbag Warning Sticker on Front Passenger Sun Visor



The Airbag Warning Symbol on sun visor reminds extreme hazards associated with the use of rearward-facing child restraint on front passenger seat during airbag deployment.

It is not taken to mean child can occupy front passenger seat and use seat belt. Please refer CRS section for recom-

mended seating position.

#### **WARNING**

Never use a rearward facing child restraint on a seat protected by an active Airbag in front of it, Death or serious injury to the child can occur.

### Airbags Deployment Conditions (if equipped)

#### When front airbags should not deploy?

**Minor frontal collision:** Seat belt offers adequate occupant protection in low severity collisions. The airbags are triggered only when there is a collision severe enough to trigger the airbags. Deployment of frontal airbags is not beneficial in low severity collisions.

**Side collision:** During a side collision, occupants tend to move sideways. Therefore, deploying frontal airbags in such situations will not benefit the occupants.

**Rear collision:** During a rear collision, occupants tend to move (rearwards) away from frontal airbags. Therefore, deploying frontal airbags in such situations will not benefit the occupant protection. Head restraints and seat belts provide occupant protection during a rear collision.

**Rollovers collision:** During a rollover collision, unbelted occupants may float inside the passenger compartment. This will increase the risk of injuries. Wearing seat belts provide highly effective occupant pro-



tection during rollover collision. Front airbags are not designed to deploy in a rollover as frontal airbags cannot offer any protection in rollover collision.

**When front airbags deploy with minor or no visible vehicle damage?**

The airbags are triggered only when there is a collision severe enough to trigger the airbags. A severe collision to the vehicle underbody or suspension may cause airbags deployment. Examples include rough road driving, running into a curb or other low fixed object that causes a sudden vehicle deceleration. Since the collision is underneath the vehicle, damage may not be readily visible.

**When front airbags not deploy, even with exterior visible vehicle damage?**

The airbags are triggered only when there is a collision severe enough to trigger the airbags. The amount of visible vehicle damage is not always the correct indicator for airbag deployment. Some collisions can result in visible damage but no airbag deployment because the airbags would not have been needed or would not have

provided protection even if they had deployed.

**CHILD LOCK (if equipped)**

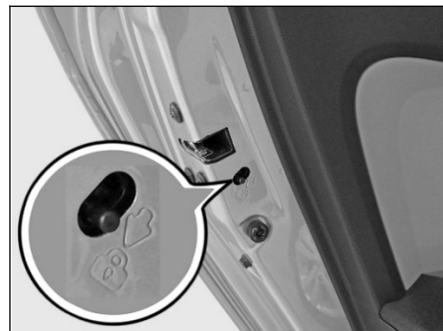

Both the rear doors of the vehicle are provided with a child proof lock. Push the lock lever located on vertical face of the door downward before closing the door. The door which has been locked by activating the child lock cannot be opened from inside, it can be opened only from the outside.

## SAFETY

---

### NOTE

- *Lift the lock lever upward to deactivate the childproof lock when not required.*
- *Child safety lever to be used for safety of child for preventing them to open rear door while seating in passenger seat to avoid accident while vehicle is running.*

## ANTI-THEFT DEVICE IMMOBILIZER / PEPS

Immobilizer system is designed to pre-vent vehicle theft by electronically disabling the engine ignition system. The engine can be started only with vehicle's original Immobilizer ignition key which has an electronic identification programmed code.

### **i** NOTE

*Use only Flip key, the other should be kept in a safe location. Note down "key Tag no." information (and keep it safe) which is required while getting new/spare keys. Remember that it is not possible to prepare new/spare keys without the "key Tag number." Take precaution about Flip key, as without Flip key vehicle cannot be started.*

Vehicle Condition	Immobilizer Lamp Status	Vehicle State	Meaning / Function Of The State
Ignition OFF	Blinking	Locked	Vehicle Immobilized and awaiting electronic key
Ignition ON	OFF	Unlocked	Normal condition and ready to start the vehicle
Ignition ON	ON	Locked	<ul style="list-style-type: none"> <li>• Problem with key (Wrong key used to start vehicle)</li> <li>• Problem with Immobilizer system. Contact a TATA MOTORS Authorized Service Centre.</li> </ul>
Ignition ON	Blinking	Unlocked	Contact a TATA MOTORS Authorized Service Centre immediately.

## SAFETY

### ANTI-LOCK BRAKING SYSTEM (ABS)

ABS regulates brake pressure in such a way that the wheels do not lock when you brake. This allows you to continue steering the vehicle when braking.



The ABS warning lamp in the instrument cluster lights up when the ignition is switched on. It goes out when the engine is running.

#### WARNING

- If ABS  is faulty, the wheels could lock when braking. The steering ability and braking characteristics may be severely impaired. There is an increased danger of skidding and accidents.
- Drive on carefully. Have ABS checked immediately at a TATA MOTORS Authorized Service Centre as soon as possible.

### While Braking

- If ABS intervenes: continue to press the brake pedal vigorously until the braking situation is over.
- To make a full brake application: press the brake pedal with full force.

If ABS intervenes when braking, you will feel a pulsing in the brake pedal. The pulsating brake pedal can be an indication of hazardous road conditions, and functions as a reminder to take extra care while driving.

#### WARNING

- The stopping distance required for vehicles with ABS may be slightly more than conventional brake system but ABS will still offer the advantage of helping you maintain directional control.
- However, remember that ABS will not compensate for bad road or weather conditions or poor driver judgment. Drive within safety margins taking into consideration into

consideration prevailing weather and traffic conditions.

## ELECTRONIC BRAKE FORCE DISTRIBUTION (EBD)

EBD monitors and controls the brake pressure on the rear wheels to improve driving stability while braking.



EBD provides optimal braking pressure distribution between front and rear wheels to optimize braking distance and to ensure vehicle stability by means of lowering braking pressure increase at rear wheels.

### WARNING

- If EBD is malfunctioning, the rear wheels can lock, e.g. under full braking. This increases the risk of skidding and an accident.
- You should therefore adapt your driving style to the different handling characteristics. Have the brake system checked immediately at a TATA MOTORS Authorized Service Centre as soon as possible.

## BRAKE SWAY CONTROL (BSC)

Detects tendency of instability during Braking in ABS-alone vehicles by monitoring individual wheel.

Enhances vehicle stability by controlling braking pressure on individual wheels during partial braking.

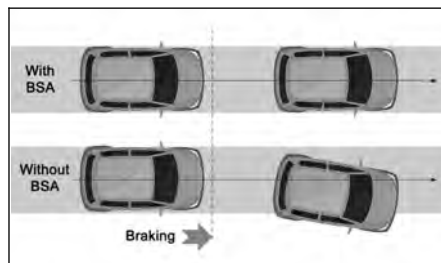



## KEYS

A key is an electronic access and authorization system available as a standard feature with your vehicle.

### Unlocking Principle

The transponder in the ignition key carries a Unique Identification Code (UID). The vehicle unlocks when the code on the key matches with the code on the Engine Management System (EMS). In case of PEPS variant, Immobilizer function is provided by PEPS ECU.

### Engine Starting

When the key is inserted and the ignition is switched to 'ON', all codes are communicated within key, Immobilizer and EMS. The engine will start only if all the codes match.

### Loss of Keys



If one of the keys is lost, Contact the TATA MOTORS Authorized Dealer/Service Center immediately.

## WARNING

- Do not turn 'ON' ignition switch by using key with any type of metal wound around its grip or in contact with it. This may be detected as abnormal condition by immobilizer and prevent engine from starting.
- Do not leave the key in high temperature areas. The transponder in it will behave abnormally when reused.
- Do not try to start the vehicle when the Immobilizer indicator lamp on the instrument cluster is glowing. In this condition the vehicle will not start and the vehicle's battery will also be drained due to frequent cranking.

## OPENING AND CLOSING

### Keys (as available)

Sn	Name	Remote Key	Description
1	Mechanical key		<ol style="list-style-type: none"><li>1. Locking all doors</li><li>2. Unlocking all doors</li></ol>
2	Smart key (PEPS)		<ol style="list-style-type: none"><li>1. Locking all doors</li><li>2. Approach light</li><li>3. Tail gate opening</li><li>4. Unlocking all doors</li></ol>
3	Wearable key		<ol style="list-style-type: none"><li>1. Customer can wear it on wrist and drive the car (ease of carrying and usage).</li><li>2. This perform dual functions of Passive entry/exit and Passive start (similar functions of Smart Key – Door lock / door Unlock/Tailgate opening / Start of vehicle)</li></ol>



### DOORS

#### Door Lock and Unlock with Key (if available)

The front doors can be locked or unlocked from outside using the key blade.



Insert the key in the slot and turn it clockwise to lock and anticlockwise to unlock the door.

#### Door Locking and Unlocking Using Door Handle Switch (DHS)

To lock/unlock all the doors without operating smart key button/ key blade. Press the door handle switch (DHS) provided on the driver door to lock/unlock all the four doors including Tail gate.

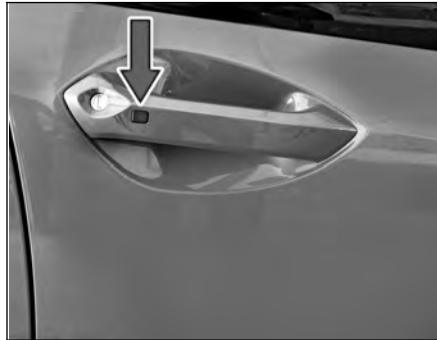

#### **i** NOTE

- *Authentication range for smart key ranges from 1 to 1.5 meters from outside the respective door or tail gate.*

- *Passive entry works only when ignition is off.*

#### Rear Door Opening



Door opening handle is provided on the side of the window.

To open the door, press the latch provided inside the handle and pull.

## OPENING AND CLOSING

### Locking Without a Key From Inside



All the doors can also be locked from inside by pressing lever on driver door and independently on other doors respectively.

### Opening the Doors From Inside



All doors can be opened from inside. To open, pull the door opening lever. All doors can be unlocked by pulling the inside release lever to the intermediate position. When it is further articulated will unlatch the door and can be opened.

## SMART KEY FEATURES

### Vehicle Search

If smart key is not within the authentication range, the turn indicators of vehicle flashes four times for the driver to locate the vehicle.

### Automatic Activation of Immobilizer

If smart key will not found within the passenger compartment, engine will be immobilized and vehicle cannot be start.

### Auto Lock/unlock of Doors/ Auto Re-lock (drive away locking)

In case of PEPS variants, door will get unlocked when ignition is OFF by pressing start/stop button.

Vehicle doors get automatically locked when all doors are closed and the vehicle speed crosses 10 kmph.

Also, when unlocked with remote key and if no door is opened within 30 seconds, vehicle doors get automatically locked.

Key is inside the vehicle and all doors closed with vehicle locked condition. In this scenario customer is informed about

the key forgotten inside the vehicle through alarm for first 10 seconds with turn indicator flashes. The flashes will continue for 180 seconds at every 20 second interval with turn indicator flashes to enable customer to take out the key from the vehicle. Customer is advised not to leave the key inside the vehicle and if the warnings are ignored by customer for entire 180 seconds, vehicle intelligence takes over the control and lock the vehicle for security reasons.

### NOTE

*Do not forget to take out key before leaving the vehicle to avoid such situation.*

### Anti-grab / Anti-scan Coding

The remote control set of this security system is protected against the use of devices called 'scanners' and 'grabbers' that can record and reproduce some types of remote codes.

### Important

- Don't press unlock button on remote in the vicinity of your vehicle, as you may accidentally unlock your vehicle.
- For battery replacement procedure, refer 'MAINTENANCE' section.
- Don't remove the battery connection of the vehicle while the vehicle has been locked by remote

### Smart Key Precautions

1. If smart key is close to radio transmitter, it may interfere with the operation of the smart key.
2. If the smart key is near a mobile two way radio system or a cellular phone, then it will not work correctly.
3. If another vehicle's smart key is being operated close to your vehicle, the signal will fluctuate.

### WARNING

Keep the smart key away from electromagnetic materials which block electromagnetic waves to the key surface

### WARNING

*In case any button of the key is accidentally pressed for more than 20 seconds, the remote stops functioning till the time the button is pressed. The LED on the Remote also stops glowing. The function of the remote gets reinstated immediately when the user stops pressing the push button of remote.*

## OPENING AND CLOSING

### Force Panic Operation

#### Force Panic ON Operation

When the vehicle is in off condition and the lock and unlock buttons are pressed at the same time, the force panic operation becomes active. In this case, the turn indicators start flashing and the vehicle starts to honk.

#### Force Panic OFF Operation

To prevent automobile thefts, the anti-theft system makes use of an anti-theft alarm (ATA). On detection of any unauthorized access, the BCM triggers the horn (acoustic alarm) and flashes the turn indicators.

### Vehicle Alarm & Security

To prevent automobile thefts, the anti-theft system makes use of an anti-theft alarm (ATA). On detection of any unauthorized access, the BCM triggers the horn (acoustic alarm) and flashes the turn indicators.

## WINDOWS

### Power Windows (if available)

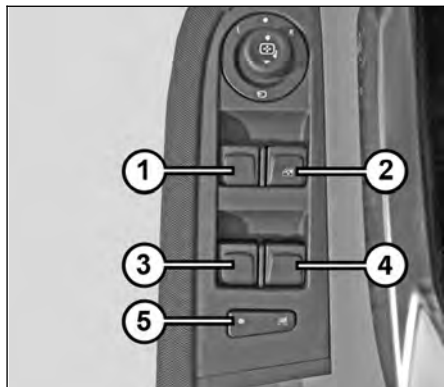

1. Front Window Winding Switch (Left)
2. Front Window Winding Switch (Right)
3. Rear Window Winding Switch (Left)
4. Rear Window Winding Switch (Right)
5. Inhibit Switch

Window glasses on all four doors can be operated by switches provided on the main control panel located on the driver's arm rest. They work only when the key is

in the 'IGN ON' position.

### **i** NOTE

*Power windows can be operated for 30 seconds in 'IGN OFF' and 'KEY OUT' positions, provided the doors are closed.*

### Express Down (if available)

Window glasses can be opened by a single long press of the switch. Express down feature is provided for the driver's door only.

### Individual Switches

Individual window winding switches have been provided on the front passenger and rear doors.

## OPENING AND CLOSING



Glasses are wound up or down by pulling or pressing the switch.

### **WARNING**

While raising the glass, take care to avoid fingers/hands getting trapped between glass and the door frame.

### Inhibit Switch



### Inhibit Switch ON

When switch is pressed, Amber light turns 'OFF'. The individual switches provided on rear and front passenger door cannot be operated. However, it can be operated from the switches on driver's arm rest.



### Inhibit Switch OFF

When switch is pressed, Amber light turns 'ON'. The individual switches provided on rear and front passenger door can be operated. It can also be operated from the switches on driver's arm rest.

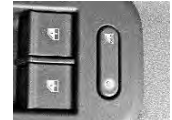

### **WARNING**

- If children operate the windows they could be get trapped, particularly if they are left unsupervised. There is a risk of injury.
- Activate the window inhibit feature when children are travel-ling. When leaving the vehicle, always take the key with you and lock the vehicle. Never leave children unsupervised in the vehicle.

## OPENING AND CLOSING

### Manual Window Winding (if available)

Use window winder handle for lowering or raising up window glasses manually where power windows are not provided.



### Opening the Bonnet

1. Make sure that the engine is switched off and vehicle is in neutral gear with the parking brake applied.
2. Pull the bonnet release lever. The bonnet will pop up slightly.



3. Lift the bonnet slightly and with your finger and slide the secondary lock lever located under the center of the bonnet.

#### **i** NOTE

*Make sure that the wiper arms are not raised before you lift up the bonnet to avoid damaging the wiper arms and the*

*bonnet.*

4. Lift the bonnet up. Pull the bonnet stay rod from its clip and put the free end into the slot provided on frame.



#### **⚠** WARNING

- The stay rod can be hot enough to burn your finger right after driving. Touch the rod after it becomes cool enough.
- Put the stay rod into the hole correctly. If the rod drops off, your body

may be caught below the bonnet.

- Deactivate the Idle Stop Start (ISS) function for any operation to be performed in the Engine compartment.

### Closing

1. To close the bonnet, hold the bon-net by one hand, disengage the stay rod and clamp it back properly.
2. Lower the bonnet close to the bumper, then let it drop down.

### WARNING

Make sure that the bonnet is correctly locked or it can fly up unexpectedly when you drive.

## TAIL GATE OPENING

### NOTE

*Some variants may have multiple options.*

### Option I



To release the tailgate, press the tail gate button on the remote.

### NOTE

- *Tail gate can be unlatched without smart key.*

- *By pressing Tailgate button on smart key and pressing tailgate door, handle switch only once with 30 second.*

### Option II

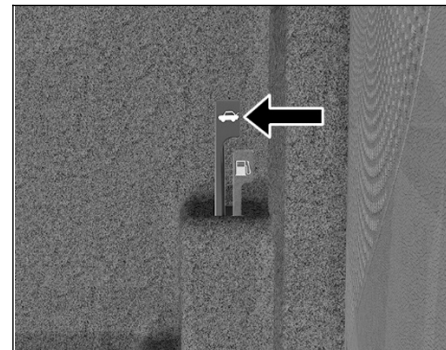

Trunk lid opening Lever is located on the right hand side of the driver seat. Lift the lever to unlock trunk lid. Lift the trunk lid.

## OPENING AND CLOSING

### Option III



Tailgate can also be opened by using door key. The lock is located on the tail gate.

For closing, pull the tail gate down and close it with a slight swing.

### FUEL LID

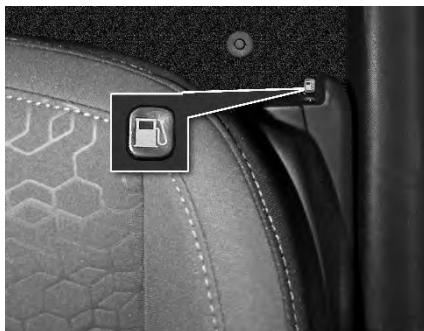

To release the fuel flap, pull the lever located at the right hand side below the driver seat.

For opening, open the fuel cap, turn it counter clockwise.



For closing, turn the fuel cap clockwise and gently push the fuel flap till it gets locked.

### WARNING

- To fill up the fuel, the Engine must be stopped by turning OFF the Ignition Key / Start-Stop but-ton. If the Engine is in Idle Stop Start (ISS) mode, it may restart automatically while filling the fuel.
- Remove the fuel filler cap slowly, and wait for any hissing to stop. The fuel may be under pressure and



may spray out.

- If fuel cap needs replacement, make sure that it is replaced by a genuine cap at the TATA MO-TORS authorized service center



## DASHBOARD AND FEATURES

### COCKPIT

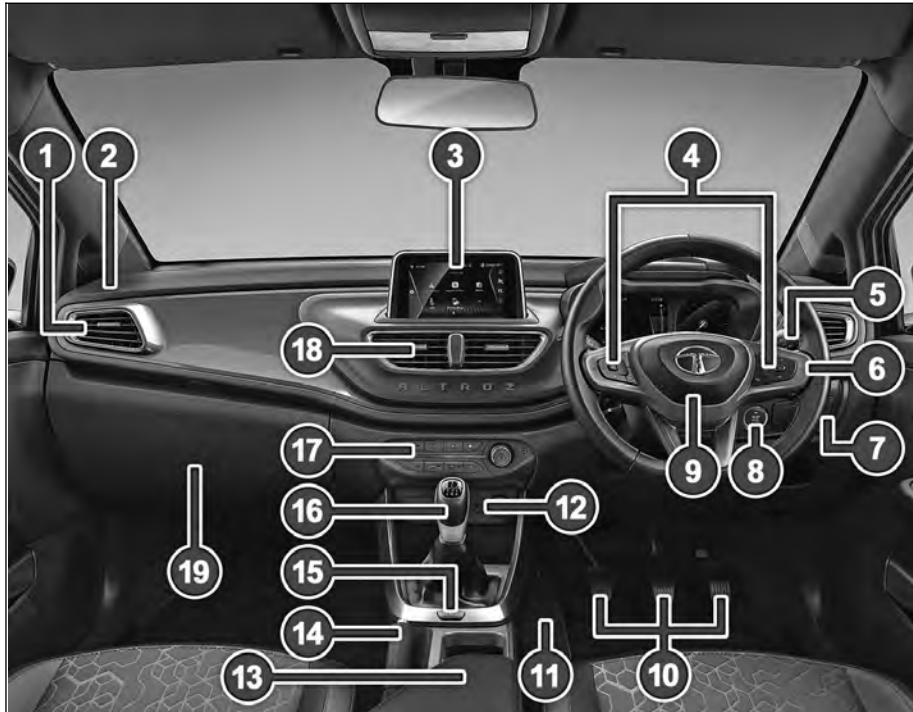

1	A.C. Air vent
2	Airbag (PAB)
3	Infotainment Display (if available)
4	Steering mounted controls (if available)
5	Combi Switch
6	Horn pad
7	Fascia switch (if available)
8	Start - Stop switch / Ignition switch (if available)
9	Airbag (DAB)
10	Controls
11	Foot Rest
12	USB Port
13	Foldable and Sliding arm-rest (if available)
14	Parking Brake Lever
15	Drive mode switch/Center lock unlock
16	Gear shift lever
17	HVAC Control panel / FATC / ETC
18	Center air vent
19	Glove box

## DASHBOARD AND FEATURES

---

### INSTRUMENT CLUSTER (TFTScreen) (as applicable)



**NOTE:** All indicators shown may not be applicable to your vehicle.

## DASHBOARD AND FEATURES

### Speedometer



Speedometer indicates the vehicle speed in kmph.

#### **i** NOTE

*At every key IN and ignition ON, the Instrument Cluster needles and gauges move to max. and return to '0' position. This is a welcome strategy and a self-check feature.*

### Tachometer



Tachometer indicates engine speed in revolutions per min (rpm).

#### **⚠** WARNING

Do not drive the vehicle with a high engine rpm. This may cause damage to the engine and reduce its life.

### Fuel Gauge

When the ignition switch is in "ON" position, fuel gauge gives an approximate in-

dication of the amount of fuel in the fuel tank. In indication window, "F" stands for full and "E" stands for empty.



When fuel in the tank nears empty, low fuel warning tell-tale light glows. Fill fuel as soon as possible.

#### **i** NOTE

- *Do a check of the fuel level when the vehicle is stationary on a level road.*
- *The fuel level displayed can vary when you drive on inclines, curves,*

## DASHBOARD AND FEATURES

*brake and accelerate suddenly. This is due to the movement of fuel in the tank. The low fuel warning lamp may turn to ON or OFF earlier or later than usual.*

### WARNING

If there is any defect in the system, Low fuel warning symbol will blink. Take your vehicle to the nearest TATA MOTORS Authorized Dealer/Service Center.

### Temperature Gauge

When the ignition switch is in the "ON" position, this gauge indicates the engine coolant temperature.



The indicator should be within the normal, acceptable temperature range i.e. between "H" and "C". If the indicator approaches "H", overheating is indicated by a RED progress bar.





If the coolant temperature is very high, the engine coolant temperature tell-tale light flashes and you will hear an audio warning. In this case, stop the vehicle, switch the engine 'OFF' and allow it to cool down for some time. Contact the nearest TATA MOTORS Authorized service centre immediately for rectification.

### WARNING



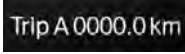

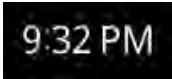
The red progress bar indicates overheating due to high coolant temperature that may damage the engine. If you

continue to drive the vehicle in this case, it can result in severe engine damage or even fire.

### Driver Information System

Driver Information	System Image	Description
Odometer		This indicates distance travelled by the vehicle. The odometer reading does not return to “0” when maximum value is reached; the display will freeze the maximum value.
Trip meter A & B	 	The trip meter can be used to measure the distance travelled on short trips or between fuel stops. It can be reset to “0”. The trip meter reading becomes “0.0” after it crosses 9999.9 km.
Clock		Indicates current time in AM/PM mode. Clock time can be changed using steering wheel switches on the steering wheel. Whenever the battery terminals or related fuses are connected, you must reset the clock time. This feature is available when ignition switch is in 'ON' position. <b>NOTE:</b> <i>Clock settings can also be changed through infotainment system. For more information, refer infotainment manual.</i>
Service reminder		This indicates how many days/kilometres are left till service is due. If service is overdue, it will display “0” km or “0” days and a spanner symbol will blink every time ignition is ON for a few seconds. Never reset the display between service intervals as it may give incorrect readings. Service reminder reset option in setting will be enable only after due condition satisfied. The information is retained in the service interval display even after the vehicle battery is disconnected. <b>NOTE:</b>

## DASHBOARD AND FEATURES

Driver Information	System Image	Description
		<i>This option is for indicative purpose only. Keep track of your odometer reading and follow the maintenance schedule.</i>
Power and Torque (if available)		This shows the power and torque figures delivered by engine in the particular driving condition.
Door Ajar		Respective door open display pop up come for few sec and then telltale with respective door open shall be displayed.
Current gear position (indicator)		<p>Current gear engaged by the transmission shall be displayed on DIS.</p> <p><b>NOTE:</b> <i>If "F" is displayed it means a defect in the system is detected Contact the nearest TATA MOTORS Authorized service centre immediately to rectify the problem.</i></p> <p><i>In case of a manual transmission, the gear number will be displayed when the clutch is fully released.</i></p>
Gear Recommendation		<p>Up or down arrow will be displayed on DIS to shift a gear up or down.</p> <p>No arrow shall be displayed when the selected gear is as per the Vehicle dynamics.</p>



### Instantaneous Fuel Economy (IFE)



It indicates fuel economy of current drive when Ignition is turned 'ON'.

To reach the Instant Fuel Economy in the Instrument cluster. Press the **<** **>** button on the RHS of the steering wheel.

IFE display does not show Fuel Economy of last drive.

The display does not show actual value unless vehicle is moving.

The indication on the display screen may be delayed if fuel consumption is affected by driving pattern.

### NOTE

*IFE will vary frequently as per driving pattern.*

### Power and Torque

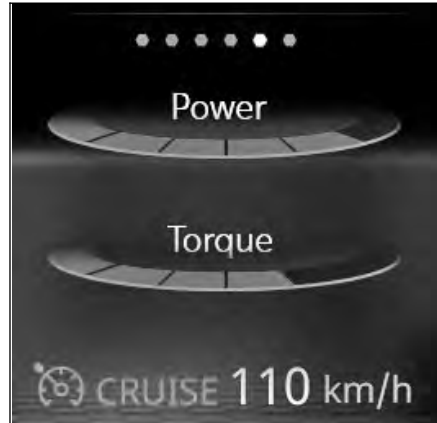

Indicates the value of Power and Torque delivered by engine in the particular driving condition.

### Average Fuel Economy (AFE)



Trip A



Trip B

## DASHBOARD AND FEATURES

AFE value is an estimate of fuel economy. It may vary significantly based upon driving conditions, driving habits and condition of the vehicle.

To see the average fuel economy in the instrument cluster, press the **<** **>** switch on the RHS of the steering wheel.

Trip time, Average speed and Trip distance will reset to '0' when respective Trip meter is reset.

### **i** NOTE

0' when Battery is removed and refitted. 0.5 km of respective trip. Once 0.5 km distance is covered, Average Fuel Economy will be displayed. Even after 0.5 km distance covered for particular trip, if Average Fuel Economy is displayed as '—.—', then take your vehicle to TATA MOTORS Authorized Dealer/Service Center.

### Distance to Empty (DTE)



The above DTE screen indicates an approximate distance in 'km' that your vehicle can travel with available fuel in tank.

To reach the Distance to Empty in the Instrument cluster. Press the **<** **>** buttons on RHS of the steering wheel.

DTE values may vary significantly based on driving conditions, driving habits, and condition of the vehicle. It is an estimate value of the available driving distance.

If low fuel warning light glows, fill the fuel tank immediately regardless of the DTE figure.

### **i** NOTE

- If DTE is displayed as '—.—', then take your vehicle to the TATA MOTORS Authorized Dealer/Service Center.
- The DTE will update with a new value when fuel is added for more than 7 litres at a time.

### Infotainment Information on Instrument Cluster Display Unit

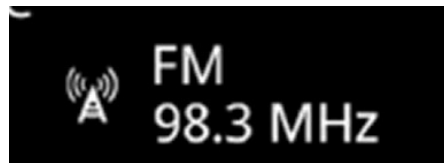

The instrument cluster will display information like media, navigation and FM.

### Setting Screen



User can enter into setting by pressing select button while being in setting screen.

#### **i** NOTE

*Service reminder reset option in setting will be enable only after due condition satisfied.*



To change the option by pressing **>** button on RHS of the steering wheel.

#### **i** NOTE

*In the Setting menu if there is no user input for 10 sec the previous screen shall be displayed.*

### Illumination Screen

User can select illumination setting by scroll down & pressing set button on the RHS of the steering wheel.



To increase the illumination from 20% to 100% in five steps by pressing **>** button on RHS of the steering wheel.

To decrease the illumination from 100% to

## DASHBOARD AND FEATURES

20% in five steps by pressing  button on RHS of the steering wheel.

### Illumination setting

If parking lamp is OFF, the option is greyed out and cannot be selectable

### Illuminated Key Ring

When the vehicle is unlocked, the illuminated key ring glows up. This helps to locate ignition switch in the dark.

### Outside Ambient Temperature



This displays outside ambient temperature reading with an accuracy of  $\pm 1$  °C.

The temperature sensor is located at the front bumper. Therefore the temperature reading can be affected by heat reflection

from the road surface, engine heat and the exhaust from surrounding traffic.

If outside temperature falls below  $-1$  °C, a “snowflake” symbol appears in addition to the outside temperature reading.

### NOTE

*For an accurate temperature reading, make sure the vehicle speed is above 30 kmph.*



### WARNING

If display shows OAT temp as “- -”, take your car to the TATA authorized service center.

### Service Reminder Setting

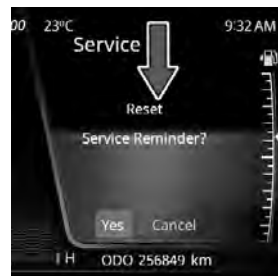
User can select Service Reminder Screen by Scroll down & pressing Set Button in Setting Screen.



User can reset the service reminder symbol by up / down   & set  buttons

### NOTE

*In the Setting menu if there is no user input for 10 sec the previous screen shall be displayed.*

### Clock

- Clock indicates current time in 12 / 24 hours mode.
- Clock mode can be changed either



through Instrument Cluster setting screen or through Infotainment system setting screen, refer infotainment system manual for this.

### Clock Setting

- User can select clock setting by scroll down & pressing set button in setting screen.



- Select button  to be used to enter into required field and exit from that.
- Up and down button to be used for changing the values.

- Up and down button to be   used for scrolling through fields of 24 hour format/hour/minute/AM/PM.
- Selected field will be highlighted as shown in above image.

## DASHBOARD AND FEATURES

### Display Messages on Instrument Cluster

Below messages may be displayed in the screen for three seconds based on the priority and some of the warnings shall be minimized in the screen.

### Interrupts Messages



**NOTE:** All messages may not be applicable to your vehicle.

Sr No	Alert	Interrupts Messages On Instrument Cluster
1	Rotate steering wheel (In ESCL jam condition)	Press Start Button While Turning Wheel
2	Key Fob battery Low	Smart Key Battery Low Replace Battery
3	Smart key out of range	Smart Key Out of Range
4	Drive Alert - Tea Break	Take a Break
5	Steering Failure, Please Stop Driving	Steering Failure Stop the Vehicle Safely
6	Steering Failure, Please Visit Garage	Steering Failure Contact Service Center
7	Pedal Press Alert Clutch	Press Clutch Pedal to Start Engine
8	Door Open alert	Door Open alert

## DASHBOARD AND FEATURES

Sr No	Alert	Interrupts Messages On Instrument Cluster
9	Press brake alert	Press brake alert
10	Cruise set speed alert	Cruise set speed alert

## DASHBOARD AND FEATURES

### Warning Messages



Sr No	Alert	Warning Messages On Instrument Cluster
1	Fuel Level Low State	Fuel Level Low
2	Fasten seat belt co-driver	Fasten Co-Driver Seat Belt
3	Fasten Seat Belt - Driver	Fasten Driver Seat Belt
4	Speed Limit Warning	Over Speeding Detected Slow Down
5	Transmission service indication	Drive Cautiously Contact Service Center
6	Shift to P	Shift to Park (P) to Exit
7	Stay in Drive mode	Stay in Drive mode for 20 Sec
8	Ensure hand brake applied	Ensure Hand brake is Applied
9	Drive control shift denied	Drive control shift denied



## DASHBOARD AND FEATURES

Sr No	Alert	Warning Messages On Instrument Cluster
10	Shift to P/N	Shift to Park or Neutral to Start Engine
11	Transmission overheat alert	Transmission Oil Temperature High
12	Transmission Failure, Limp home activated	Malfunction Detected Contact Service Center

## DASHBOARD AND FEATURES

### Information Messages



Sr No	Alert	Information Messages On Instrument Cluster
1	Park Brake Engaged	Park Brake Engaged
2	Auto Headlamp	Auto Headlamp Activated
3	Resume to Target Speed Not Possible in Current Gear	Change Gear to Resume Cruise Speed
4	Cruise Override	Cruise Override
5	ISS-Start the Engine	Auto Stop Start the Engine
6	Autonomous Start Enabled - Battery SOC Low	Auto Start Enabled Low Battery Charge.
7	Autonomous Start Enabled - Brake Vacuum Low	Auto Start Enabled Low Brake Assist Vacuum

## DASHBOARD AND FEATURES

Sr No	Alert	Information Messages On Instrument Cluster
8	Autonomous Start Enabled – Coolant Temp Low	Auto Start Enabled Low Coolant Temperature
9	Auto Start Enabled High Steering Angle	Auto Start Enabled High Steering Angle
10	Auto Start Enabled Start Vehicle Rolling	Auto Start Enabled Vehicle Rolling
11	Auto Start-Stop Enabled Text Alert	Auto Start- Stop Enabled
12	Auto Start-Stop Disabled Text Alert	Auto Start- Stop Disabled

## DASHBOARD AND FEATURES

### INSTRUMENT CLUSTER (LCDScreen)

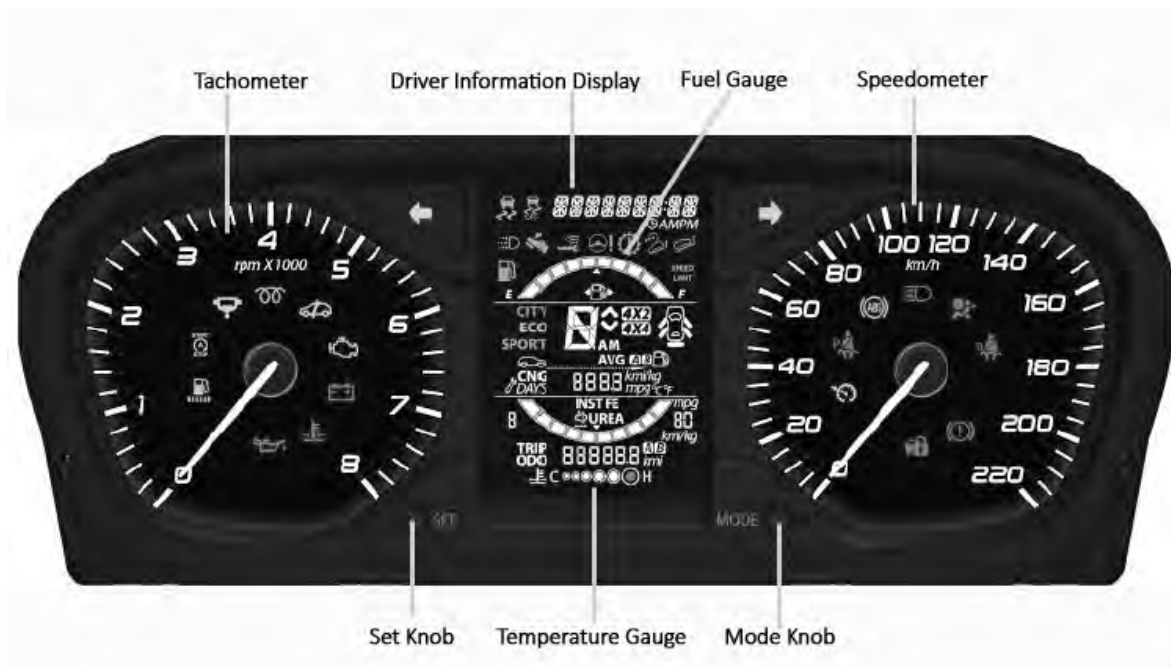

**NOTE:** All indicators shown may not be applicable to your vehicle.

### Speedometer



Speedometer indicates the vehicle speed in kmph.

#### **i** NOTE

*Whenever you turn the ignition on, after inserting key in ignition switch the Instrument Cluster needles and gauges move to maximum value and return to '0' position. This is a welcome strategy and a self-check feature.*

### Tachometer



Tachometer indicates engine speed in revolutions per min (rpm).

#### **⚠** WARNING

Do not drive the vehicle with high engine rpm. This may cause damage to the engine and reduce its life.

### Fuel Gauge

When the ignition switch is in "ON" position, fuel gauge gives an approximate indication of the amount of fuel in the fuel tank. "F" stands for full and "E" stands for empty.



#### **i** NOTE

- Do a check of the fuel level when the vehicle is stationary on a plain surface.
- The fuel level displayed can vary when you drive on inclines, curves, brake and accelerate suddenly. This is due to the movement of fuel in the tank. The low fuel warning lamp may turn to ON or OFF earlier or later than usual.

## DASHBOARD AND FEATURES

### WARNING

If there is any fault in the system, Low fuel warning symbol will start blinking. Take your vehicle to the nearest TATA MOTORS Authorized Dealer/Service Center.

### Temperature Gauge

When the ignition switch is in the "ON" position, this gauge indicates the engine coolant temperature.



The indicator should stay within the normal, acceptable temperature range between "H" and "C". If the indicator approaches "H", overheating is indicated by a red bar.







If the coolant temperature reading is very high, the engine coolant temperature tell-tale light flashes with an audible buzzer. In this case, stop the vehicle, switch 'OFF' the engine and cool it down for some time. Contact the nearest TATA MOTORS Authorized Dealer/Service Center immediately for rectification.

### WARNING

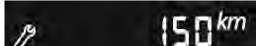

The red progress bar indicates overheating, due to high coolant temperature which may damage the engine.

Continuing to drive the vehicle in this case can result in severe engine damage or even fire.

### Driver Information System (DIS)

Driver Information	System Image	Description
Odometer		Indicates distance travelled by a vehicle. The Odometer reading does not return to “0” when maximum value is reached, the display will freeze to maximum value.
Trip meter A & B	 	The trip meter can be used to measure the distance travelled on short trips or between fuel stops. It can be reset to “0”. The Trip meter reading becomes “0.0” after it crosses 9999.9 km.
Clock		Indicates current time in AM/PM mode. Clock time can be changed using ‘SET’ & ‘MODE’ knob. Whenever the battery terminals or related fuses are connected, you must reset the clock time. This feature is available when ignition switch is in ON position. <b>NOTE:</b> Clock settings can also be changed through infotainment system. For more information, refer infotainment manual.
Door Ajar		This warning will be indicated when the driver’s door or front passenger door is open.
Service reminder	 	This indicates how many days/kilometres are left till service is due. If service is overdue, it will display “0” km or “0” days and a spanner symbol will blink every time ignition is ON for a few seconds. Never reset the display between service intervals as it may give incorrect readings. The informa

## DASHBOARD AND FEATURES

Driver Information	System Image	Description
		<p>tion is retained in the service interval display even after the vehicle battery is disconnected.</p> <p><b>NOTE:</b>  <i>This option is for indicative purpose only. Keep track of your odometer reading and follow the maintenance schedule.</i></p>
Current gear position indicator		<p>Current gear engaged by the transmission shall be displayed on Driver Information System.</p> <p><b>NOTE:</b>  <i>If "F" is displayed it means a 'Fault' condition. Contact the nearest TATA MOTORS authorized service centre immediately            In case of manual transmission, the gear number shall be displayed even when the clutch is fully released.</i></p>
Gear Recommendation		<p>Up or down arrow will be displayed indicating for a gear change. No arrow shall be displayed when the selected gear is as per the vehicle dynamics.</p>



### Instantaneous Fuel Economy (IFE)



Monitor the IFE bar graph to achieve better fuel economy.

IFE display does not show Fuel Economy of last drive.

The above image indicates real time fuel economy when the ignition is turned 'ON'.

The display does not show actual value unless vehicle is moving.

The indication on the display may be delayed if fuel consumption is affected by driving pattern.

#### **i** NOTE

- IFE will vary frequently as per driving pattern.
- IFE display does not show Fuel Economy of last drive.

### Average Fuel Economy (AFE)



Trip time, average speed and trip distance will reset to '0' when respective trip meter is reset.

Average Fuel Economy will be displayed as '—.—' for initial 0.5 km of respective trip. Once 0.5 km distance is covered, Average Fuel Economy will be displayed.

Even after 0.5 km distance covered for particular trip, if Average fuel economy is displayed as '—.—', then take your vehicle to the nearest TATA MOTORS authorized service centre.

#### **i** NOTE

- AFE value is an estimate of fuel economy. It may vary significantly based upon driving conditions, driving habits and condition of vehicle.
- Average Fuel Consumption will get reset to '0' when Battery is removed and refitted.

## DASHBOARD AND FEATURES

---

### Distance to Empty (DTE)



The above image indicates an approximate distance in 'km' that your vehicle can travel with available fuel in tank.

DTE values may vary significantly based on driving conditions, driving habits, and condition of the vehicle. It is an estimate value of the available driving distance.

The DTE figure will update with a new value when fuel is added for more than seven litres at a time.

If low fuel warning light glows, fill fuel immediately regardless of the DTE figure displayed.

#### **i** NOTE

*If DTE is displayed as '—', then take your vehicle to the TATA MOTORS Authorized Dealer/Service Center.*

### Outside Ambient Temperature



This displays outside ambient temperature reading with an accuracy of  $\pm 1$  °C. Since the temperature sensor is located at the front bumper of the vehicle, the temperature reading can be affected by heat reflection from the road surface, engine heat and the exhaust from surrounding traffic.

## Driver Information System (DIS) Setting

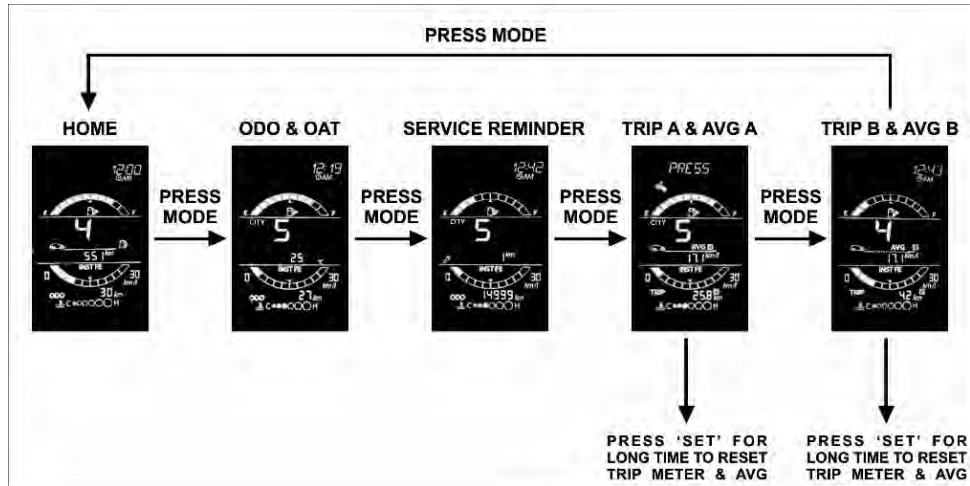

## DASHBOARD AND FEATURES

### Instrument Cluster Illumination Setting

Instrument cluster's brightness intensity and backlight intensity will turn on after the Parking lamp is ON.

#### **WARNING**

The clock and illumination settings should be changed only when the vehicle is in stationary condition for safety purposes.

### Illumination setting procedure

- For illumination setting short Press SET button with position lamp ON.
- Change illumination levels by short pressing SET button.

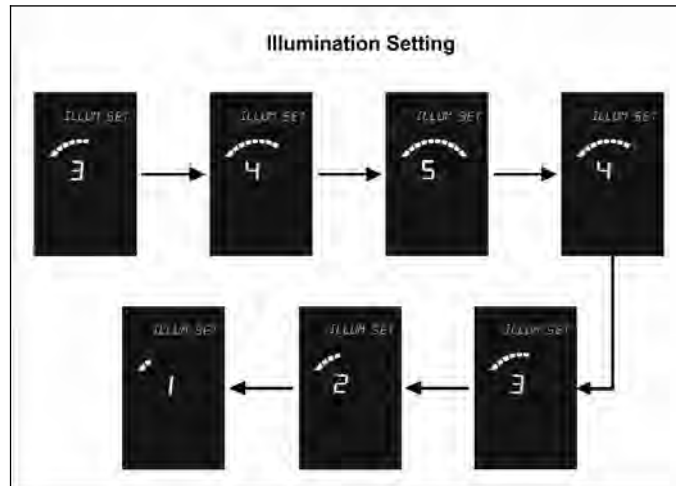

### Clock Setting

#### **NOTE**

- If parking lamp is ON and by short pressing SET button you can enter into illumination set-ting.
- If user want to go to clock screen Short press MODE button.
- If user want clock in 24/12 hour format, in any screen on Long press MODE button, clock changes to 12/24 hour format respectively.

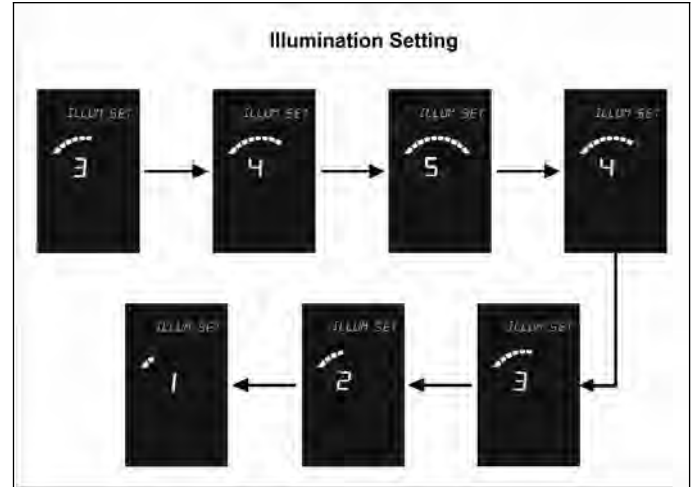

## DASHBOARD AND FEATURES

### Display Messages on Instrument Cluster

Below messages can be displayed on the screen for four seconds based on the priority.

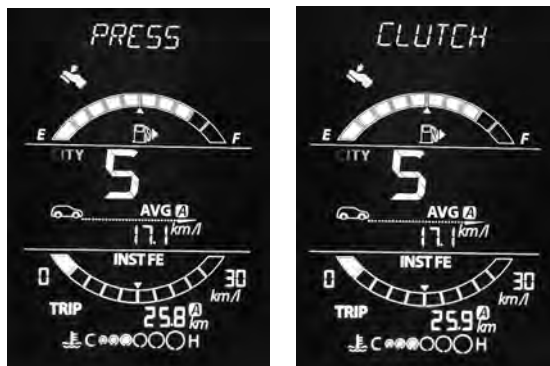

**NOTE:** All messages may not be applicable to your vehicle

Sr No	Information	String On Lcd Screen
1	Speed Limit Warning	OVERSPEED
2	Engine Is Locked	ENGINE LOCKED
3	Low Brake Fluid	LOW BRAKE FLUID
4	Brake Lamp Failed	BRAKELAMP FAILED
5	Reverse Lamp Failed	REVERSE LAMP FAIL
6	Service Reminder Days	SERVICE DUE
7	Service Reminder Kms	SERVICE DUE

## DASHBOARD AND FEATURES





Sr No	Information	String On Lcd Screen
8	Fuel Level Low State	LOW FUEL
9	Key Fob battery Low	KEY BATT LOW
10	Smart key out of range	KEY OUT OF RANGE
11	Rotate steering wheel (In ESCL jam condition)	ROTATE STEERING
12	Resume to Target Speed Not Possible in Current Gear	UNABLE TO RESUME
13	Cruise is Resuming to set speed	CRUISE RESUMED
14	Press CLUTCH for MT	PRESS CLUTCH
15	ISS OFF	ISS OFF
16	Please Crank	PLZ CRANK
17	Autonomous Start Enabled - Battery SOC Low	AUTOSTART
18	Autonomous Start Enabled - Brake Vacuum Low	AUTOSTART
19	Autonomous Start Enabled – Cabin Temp high	AUTOSTART
20	Autonomous Start Enabled – Coolant Temp Low	AUTOSTART
21	Drive alert - Tea break	Take a break
22	Electronic stability OFF	ESF OFF
23	HDC deactivation due to speed above set value	HDC deactivate
24	Hill decent control active	HDC active
25	Press brake for DCT	Press Brake
26	Cruise OFF	Cruise OFF
27	Cruise override	Cruise override
28	Transmission service indication	DCT fault

## DASHBOARD AND FEATURES





Sr No	Information	String On Lcd Screen
29	Transmission overheated	DCT temp high
30	Shift to P/N	Shift P/N
31	Owner's Birthday	Happy Birthday
32	Shift to P	Shift > P
33	Transmission failure ,Limp home activated	DCT fault
34	Drive control shift denied	Shift denied
35	Ensure hand brake applied	Ensure hand brake
36	Stay in D mode	Stay in D for 20 S







### TELL TALES

Warning Lamps	Color	Indicator	Remarks
Malfunction Indication Lamp (MIL)	Amber		<ol style="list-style-type: none"> <li>1. The lamp comes on when ignition is switched 'ON'. Once engine is started, it turns 'OFF'.</li> <li>2. It remains 'ON' for any engine related fault that may increase emission levels of the vehicle beyond the regulatory norms. Contact the TATA MOTORS Authorized Dealer/Service Center for rectification</li> </ol>
Check Engine Lamp	Amber		<ol style="list-style-type: none"> <li>1. The lamp comes on when ignition is switched 'ON'. Once engine is started, it turns 'OFF'.</li> <li>2. Illuminates continuously if a fault arises in Engine Management System. Contact the TATA MOTORS Authorized Dealer/Service Center.</li> </ol>
Immobilizer (if available)	Red		<ol style="list-style-type: none"> <li>1. The lamp comes on when the system disables the engine start if the original key is not used.</li> <li>2. Lamp blinks: Vehicle is in immobilized condition when key is not inserted.</li> <li>3. Lamp ON: Problem with key/system. Contact TATA MOTORS</li> <li>4. Authorized Dealer/Service Center.</li> <li>5. Lamp OFF: Normal condition (Authenticated user) and engine will start.</li> </ol>
Pre-Heat indicator / Glow Plug indicator (Diesel)	Amber		<ol style="list-style-type: none"> <li>1. The lamp comes on when ignition key is in 'ON' position.</li> <li>2. Start the engine only after this indicator goes 'OFF'.</li> </ol>





## DASHBOARD AND FEATURES

Warning Lamps	Color	Indicator	Remarks
Turn Signal	Green		Indicates direction indicated by the turn signal. While you operate the left/right turn indicator, the turn signal blinks along with the buzzer (when ignition is 'ON'). The direction indicator arrow on the instrument cluster flashes along with the selected external indicator lights. Both tell-tale lights will blink simultaneously when the hazard switch is pressed irrespective of whether the ignition ON or OFF. A tick-tock sound will be heard in both cases.
High Beam	Blue		The lamp comes on when the high beam headlamps are switched 'ON' or flashed.
Low Oil Pressure indicator	Red		The lamp comes on when ignition is switched 'ON' and goes 'OFF' once required engine oil pressure is developed after starting the engine. If the low oil pressure indicator does not glow or remains 'ON' when the engine is running, it indicates a fault in the electrical circuit/lubrication system. Contact the nearest TATA MOTORS Authorized service centre to rectify the issue.
Battery charging	Red		The lamp comes on when ignition is switched 'ON'. Once engine is started, it turns 'OFF'. If it remains 'ON' while the engine is running, it indicates that the battery is not getting charged. Switch off all unnecessary electrical equipment and contact the nearest TATA MOTORS Authorized service centre.







## DASHBOARD AND FEATURES

Warning Lamps	Color	Indicator	Remarks
Airbag status	Red		The lamp comes on when ignition is switched 'ON' and goes 'OFF'. If it continuously blinks then contact the TATA MOTORS Authorized Dealer/Service Center immediately.
Park Brake / Brake Fluid Low / EBD malfunction	Red		The lamp comes on momentarily when ignition is switched 'ON'. Once parking brake is released, it turns 'OFF'. If it remains 'ON', then it indicates: <ol style="list-style-type: none"> <li>1. Brake fluid level is low.</li> <li>2. Park brake is applied.</li> <li>3. EBD malfunctioning.</li> </ol>
Cruise Control lamp (if available)	Green		The lamp comes on when ignition is switched 'ON'. Once engine is started, it turns 'OFF'. The Cruise Control is used to indicate the status of cruise control system to the driver. If the lamp is on, it indicates that the cruise control feature is activated.
High Coolant Temperature	Red		The lamp comes on when ignition is switched 'ON'. Once engine is started, it turns 'OFF'. If the engine overheats due to higher coolant temperatures, this indicator blinks along with an audible buzzer. Contact your nearest TATA MOTORS authorized service Centre immediately. When the engine coolant temperature reaches the maximum limit, the tell-tale lights blink with a RED colour and you will hear an audio warning. Note: Do not remove the radiator pressure cap from the radiator when the engine is hot. Do not restart the engine until the problem has been duly attended.



## DASHBOARD AND FEATURES

Warning Lamps	Color	Indicator	Remarks
ABS	Amber		<p>The lamp comes on when ignition is switched 'ON'. Once engine is started, it turns 'OFF'.</p> <p>The lamp remains on if there is any malfunction in ABS. Normal braking system will be operational without assistance of ABS. Contact the TATA MOTORS Authorized Dealer/Service Center immediately.</p>
SPORT (if available)	Amber		<p>This symbol comes ON when SPORT driving mode is activated when more torque is required.</p>
Low Fuel indicator	Amber		<p>The lamp comes on when ignition is switched 'ON'. Once engine is started, it turns 'OFF'.</p> <p>The symbol lights up continuously if fuel level in the tank is low. Fuel needs to be filled immediately.</p> <p><b>Note:</b> The tell-tale warning light will start flashing if there is any fault in the fuel system. Contact the nearest TATA MOTORS Authorized Dealer/Service Center immediately.</p>
Driver Seat belt indicator	Red		<p>The driver seatbelt warning indicator remains ON, when ignition is turned ON.</p> <p>The warning lamp remains ON as long as the driver seatbelt is not fastened.</p> <p>If seatbelt remains unbuckled and vehicle goes above 15 kmph, then final audio warning will go on for 90 seconds.</p> <p><b>Note:</b></p>

## DASHBOARD AND FEATURES

Warning Lamps	Color	Indicator	Remarks
			Once the seatbelt is fastened the buzzer and warning lamp turns OFF. Seatbelt reminder remains OFF when reverse gear is engaged.
Key Not Detected (if available)	Amber		This lamp comes on when the Valid Smart key is not detected inside the vehicle.
Press Clutch Pedal to Start Engine (if available)	Amber		This lamp comes on with IGN ON till user presses the clutch pedal to start the engine.
Water in fuel indicator (Diesel)	Amber		The lamp remains on if excess water is accumulated in the fuel filter. When this lamp blinks along with chime contact the nearest TATA MOTORS Authorized Dealer/Service Center to drain the water immediately to avoid serious damage to the fuel injection system.
Daytime running lamps DRL (if available)	Amber / Green		The lamp comes on when ignition is switched 'ON'. Once engine is started, it turns 'OFF'. This lamp comes on when the Daytime Running lamp is 'ON'. <b>Note:</b> Parking lamp should be on to start the DRL lamp.
Door Ajar lamp (if available)	White / Red		All four door and Tail gate are indicated independently when the respective door or tail gate is open.
Front Passenger Seat belt indicator	Red		The co-driver seatbelt warning indicator turns ON when ignition is turned ON.

## DASHBOARD AND FEATURES

Warning Lamps	Color	Indicator	Remarks
			<p>If front passenger seat is occupied by adult, the warning lamp remains ON as long as the co-driver seatbelt is not fastened.</p> <p>If seatbelt remains unbuckled and vehicle goes above 15 kmph, then final audio warning will go on for 90 seconds.</p> <p><b>Note:</b> Once the seatbelt is fastened the buzzer and warning lamp turns OFF. Seatbelt reminder remains OFF when reverse gear is engaged.</p>
Speed limit warning indicator	Amber		<p>When the vehicle speed crosses 80 kmph, then speed limit warning indicator turns 'ON' along with an audio chime for every two minutes (audible warning).</p> <p>If vehicle speed crosses 120 kmph, the speed limit warning indicator flashes along with an audio warning continuously, until the vehicle speed is above 120 kmph.</p> <p>If vehicle speed is between 80 kmph and 120 kmph, then the audio warning will become less frequent but the speed limit warning Indicator will remain 'ON' continuously. When the vehicle speed is reduced below 80 kmph, then the speed limit warning indicator and the audio warning will turn off.</p>
ECO (if available)	Green		<p>The lamp comes on when ignition is switched 'ON'. Once engine is started, it turns 'OFF'.</p> <p>When ECO lamp is ON, it indicates the car is in 'Economy' drive mode, which helps to achieve a better fuel economy.</p>
CITY	White / Blue		<p>The lamp comes on when ignition is switched 'ON'. Once engine is started, it turns 'OFF'.</p>

## DASHBOARD AND FEATURES

Warning Lamps	Color	Indicator	Remarks
			If CITY lamp is ON, it indicates 'City' drive mode, which helps to achieve optimum torque and fuel economy.
DPF (if available)	Amber		<p>The DPF warning light or symbol switches 'ON' continuously to indicate that the DPF needs to eliminate the trapped pollutants (particulate matter) through the re-generation procedure. The warning light or symbol switch 'ON' only when driving conditions require the driver to be notified.</p> <p>DPF 'ON' does not indicate a malfunction.</p> <p>To switch off the warning light or symbol, keep the car running on road until regeneration is complete (ideally at 3<sup>rd</sup> gear, 50-80 kmph, with engine speed over 2000 rpm).</p> <p>The process normally takes about 20 minutes.</p> <p>The warning light or symbol remains off during the entire DPF regeneration procedure</p> <p>If the procedure is not followed, MIL lamp will switch ON, along with DPF lamp on Instrument cluster.</p> <p><b>Note:</b> Please follow the above-recommended DPF regeneration procedure to avoid MIL lamp switch 'ON'. In case, MIL lamp switch ON, please contact nearest TATA authorized service centre to restore DPF operation.</p>

## DASHBOARD AND FEATURES

### AUDIO REMINDER (as available)

#### Key-in Reminder/audio Warning

If you forget the key inside the vehicle when you leave the ignition in 'OFF' position, an audio warning will sound. Remove key to stop the warning.

#### If No Key is Detected in the Vehicle

If the vehicle is in ACC ON/IGN ON and the customer takes the smart key out of the vehicle and closes the last door, an audio warning will be sounded for nine times to alert that the key is not in the vehicle.

#### NOTE

*In this condition customer needs to bring the smart key inside the vehicle.*

#### Parking Lamp 'ON' Reminder

If you forget to turn OFF the park lamp, an audio warning will be started. Switched OFF the park lamps to stop the warning.

#### NOTE

*Do not forget to turn OFF your park lamp as it may drain the vehicle's battery.*

#### Parking Brake 'ON' Reminder

If Park Brake is applied and vehicle is driven, Telltale will turn 'ON' and buzzer will provide audio warning continuously. Disengage the park brake to stop audio warning.

#### Reverse Gear Reminder

If reverse gear is engaged, the buzzer sound will alert you.

#### Driver Seat Belt Reminder

If seatbelt is not fastened and vehicle goes above 15 kmph, then final audio warning will go on for 90 seconds. Seat belt tell-tale light will remain continuously ON when audio alarm is active.

#### Front Passenger Seat Belt Reminder

If front passenger has not fastened seatbelt and if vehicle speed goes above 15 kmph, then final audio warning will go on

for 90 seconds. Seat belt tell-tale light will remain continuously ON when audio alarm is active.

#### NOTE

*Fasten the seatbelt to stop audio warning.*

#### Door Open Reminder

If any door is open and the user tries to lock the vehicle, one flash with a beep sound will indicate that a door is open.

#### Engine Coolant Temperature High Chime

The engine coolant temperature tell-tale warning light along with an audio warning will alert the driver if the coolant temperature is high.

#### Speed Limit Chime

When speed of the vehicle is greater than 80 kmph, an audio warning will sound at periodic interval of 120 seconds.

When vehicle speed crosses 120 kmph, continuous audio warning (beeps) will sound.



### Drive Mode Chime

When user switches drive mode from city to eco or eco to city, a single audio warning will sound.

### Electronic Steering Column Lock (ESCL) Chime

This feature informs the driver to rotate steering wheel when ESCL gets engaged accidentally.

### WIF (Water in fuel) / FFC (Fuel filter clog) Chime

If water is detected in fuel buzzer shall sound to alert you.

### COMBI SWITCH (RH Stalk) (if available)

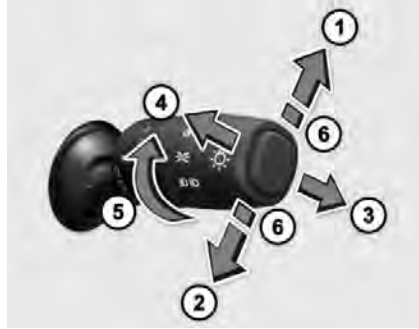

#### 1. Left Turn Signal

Move the lever fully upward.

#### 2. Right Turn Signal

Move the lever fully downward.

#### **i** NOTE

*When the turn is completed, the signal will cancel and the lever will return to its normal position*

#### 3. High Beam

Move the lever forward to select the high beam function.

Pull the lever back to normal for low beam.

#### 4. High Beam Flash (spring return)

To flash the high beam, pull the lever towards you from the normal position. It will return to its normal position when you release it.

#### Headlamp Rotary Switch

##### OFF Position

All lamps will remain 'OFF'



##### Parking Lamp

Rotate stalk to turn 'ON' the Parking lamps.



##### Low Beam

Rotate stalk to turn 'ON' the Low Beam function



##### Auto Light

The headlights will be automatically switched ON depending on ambient light conditions (while



## DASHBOARD AND FEATURES

entering a tunnel or when it is twilight).

### Day Time Running Lamps

Day time Running Lamps (DRL)  are used to increase the visibility of the vehicle to other drivers during daytime.

1. To activate and deactivate DRL, keep the ignition switch is 'ON' position and switch the parking lamp ON-OFF twice.
2. Activation and Deactivation of DRL can be done by DRL soft switch, which is available on the Infotainment Display.

### 6. Lane Change Signal

To signal a lane change, move the lever slightly up or down to the point where the turn signal light begins to flash for six times, but the lever does not latch. The turn signal will flash six times automatically.

### HEAD LAMP LEVELING ROTARY SWITCH

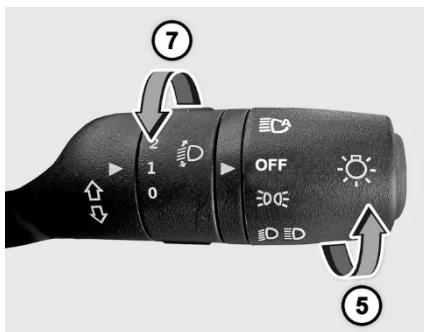

Inner rotary switch on right hand stalk is provided for head lamp leveling. With the inner rotary switch, Head lamp leveling can be done with head lamp in Low Beam and in 'ON' position. Select correct position before start of trip, when the vehicle is stationary. Depending on the number of passengers and luggage in the vehicle headlamp focus may change. This can be adjusted by rotating the knob to one of the three level positions.

### COMBI-SWITCH (LH Stalk) (if available)

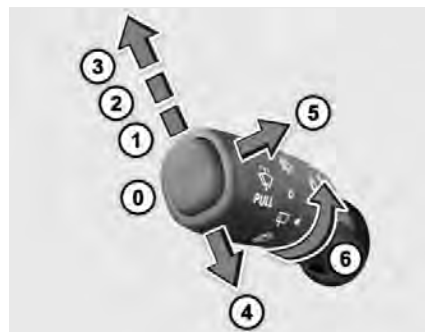

#### 'OFF' Position

The wiper is switched 'OFF'.

#### Intermittent Wipe

Push the stalk upwards to operate intermittent wipe. 

Inner rotary switch on left hand stalk is provided for intermittent front wiper delay. The switch has five delay timers. Push the stalk towards position (1) for single wipe.

### 2. Slow Wipe

Push the stalk towards position (2) for continuous slow wipe.

### 3. Fast Wipe

Push the stalk towards position (3) for continuous fast wipe.

### 4. Flick Wipe (spring return)

Pull the stalk downwards and hold it for continuous wipe, the wiper continuously wipes across the windshield at low speed till the stalk is released.



### Front Windshield Washer

- Pull the lever little longer, to spray the washer fluid on the windshield.
- The windshield wipers will operate for three cycles after the lever is re-leased and for one more cycle after five seconds.

### Auto Front Wipe

If your vehicle is fitted with rain and light sensor, the wipers will automatically wipe the windscreen, if it senses rainfall. Make sure that the wiper stalk is in Auto position.

#### **i** NOTE

*When you crank the engine, the supply to washer motor is momentarily cut off.*

### Rear Wash And Wipe

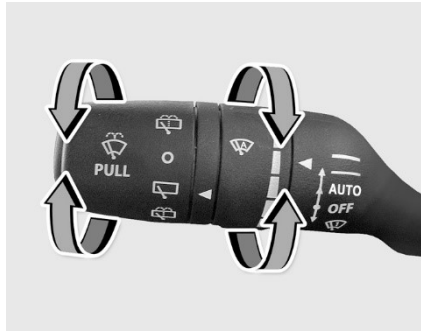

### Rear Windshield / Wiper and Washer (spring return)

Turn the rotary knob clockwise and release to operate rear windshield wash and wipe. The windshield wipers will operate for three cycles.



### Rear Wipe

Turn the rotary knob counter clockwise such that it aligns its positions with arrow mark to operate rear windshield wiper continuously.



#### **i** NOTE

*Rear wiper will not work as long as tail-gate is open.*

### Rear Windshield/ Wiper and Washer Switch

Turn the rotary knob counter clockwise such that it aligns its positions with the arrow mark to operate rear windshield wash and wipe function. It will return to 'Rear wipe' position as soon as it is released and continues to wipe.



## DASHBOARD AND FEATURES

### NOTE

*When you reverse the car with front wipers in 'ON' condition, the rear wiper will also be 'ON'.*

### WARNING

If you operate wash and wipe function for more than 15 seconds the controller cuts off the supply to the washer motors to avoid overheating.

### Rain/light Sensor (as available)

The integrated rain and light sensor is mounted on front windshield glass to sense rain and light.

As per the input from sensor, the wipe and light functions will work automatically.

## DASHBOARD CONTROLS

Fascia switches are provided on driver side dashboard.

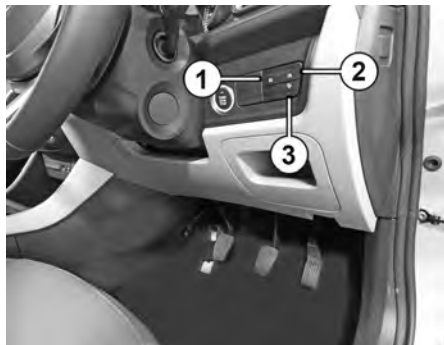

1. Front Fog lamp switch
2. Rear Fog lamp switch
3. Idle stop start switch (ISS)

## Front Fog Lamps (if available)



The front fog lamps are located on the front bumper. In poor visibility conditions due to fog, snow or rain, the fog lamps make visibility better and make it easier for other road users to see you. It turns to 'ON' when the fog lamp switch is turned on when the ignition is 'ON' and when the position and parking/ head lamp is 'ON'. An indicator on the instrument cluster will come on when the front fog light is 'ON'.

## DASHBOARD AND FEATURES

### STEERING MOUNTED CONTROLS (LHS) (if available)



#### 1. Volume

Press above switch to increase or decrease volume of music system / radio.

#### 2. Seek Forward/backward

Press above switch to change radio channels.

#### 3. Receive Calls/PTT (Push to Talk)

Press above switch to accept incoming call when a cell phone is connected via Bluetooth.

### Fog Lamp as Cornering Lamp

The front fog lamps also function as cornering lamps to light up the area to the side of the vehicle, making night-time parking and turning safer.

### Rear Fog Lamps (if available)



Rear Fog Lamp is available on the rear bumper for better visibility in adverse weather conditions to avoid accidents. The rear fog lamp can be switched 'ON' with ignition and headlamp or front fog lamp is 'ON'.

### Idle Stop Start Switch (ISS) (if available)

Your car is equipped with push Button on right side of the dashboard to Enable OR Disable ISS function.

For more details refer 'starting & driving' section.

## DASHBOARD AND FEATURES

### Voice Recognition

To start, press the voice activation button provided on the steering wheel. The system mutes/ pauses the currently played audio and you will hear a beep sound to indicate the activation of the voice recognition feature. The system displays the Voice Recognition screen on Infotainment to indicate activation of the feature.

#### **i** NOTE

*The system will start recognizing your voice command only after the beep. So, speak your command only after you hear the voice activation beep.*

### 4. Mute/phone Reject

Press above switch to reject or hang up a phone call. It is also used to mute the volume of music system/radio.

### 5. Source

Press above switch to select the required source in the infotainment system i.e. USB, AM, FM and Bluetooth.

## STEERING MOUNTED CONTROLS (RHS) (if available)

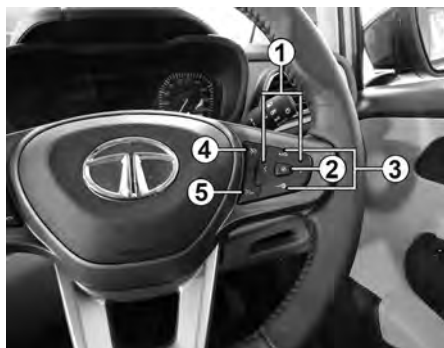

### 1. Instrumentation Controls(IC)

#### Instrumentation Controls Scroll LH

Press above switch to scroll LH on Instrument Cluster display

#### Instrumentation Controls Scroll RH

Press above switch to scroll RH on Instrument Cluster display.

### 2. OK / Select & Long Press for Settings

Press the above switch to select the option and long press it (approx. three seconds)

to go directly to the instrument cluster settings.

### 3.Cruise Set (reset)

#### Speed Increase (decrease) Switch

- Press the cruise control master switch on steering wheel.
- Accelerate the vehicle to the desired speed.
- Make sure that the Clutch and Brake pedals are not pressed.
- Press the 'SET' button on steering wheel switch to set the desired cruise speed. The cruise control indicator on instrument cluster will turn 'ON'.
- Remove your foot from the accelerator pedal.

Once Cruise control is activated the vehicle automatically maintains the stored speed.

#### Changing the Set Cruise Speed

The set cruise speed can be adjusted using the buttons '+' (to increase) or '-' (to decrease) on steering wheel.

The speed increases and decreases on a

single press.

The changed speed will be shown on the speedometer.

Keeping the switch pressed increases or decreases the speed continuously till the switch is re-released or maximum/ minimum speed limit for particular gear is reached.

The set speed can also be increased by pressing the accelerator pedal till the desired speed is achieved and then pressing the 'SET' button.

The set speed can also be decreased by pressing the brake pedal (The cruise indicator will turn OFF) and slowing down to desired speed and then pressing the 'SET' button (The cruise control indicator will turn 'ON' again).

### 4. Cruise Control Master Switch

Cruise speed can be resumed only if cruise control is deactivated by applying the brake. To resume the previously set cruise speed, accelerate the vehicle to a speed as per gear selected as below:

3<sup>rd</sup> gear approx. 30Kmph to 80Kmph

4<sup>th</sup> gear approx. 40kmph to 120Kmph

5<sup>th</sup> gear approx. 50kmph to 140Kmph

### 5. Cruise Control Deactivating Switch

There are two ways to deactivate cruise control:

Applying brake / clutch.

Press deactivation switch on Steering Wheel.

#### NOTE

*For more information, refer infotainment manual. Refer link - <https://cars.tatamotors.com/service/owners/owners-manual>*

*For compatible list of phones, refer link: <https://cars.tatamotors.com/service/owners/phone-bluetooth-compatibility-with-car-infotainment-system>*

### MIC



Mic is provided on the roof near the roof lamp.

## DASHBOARD AND FEATURES

### INFOTAINMENT SYSTEM DISPLAY (if available)

#### Option I



#### Option II



#### **i** NOTE

For more information, refer infotainment manual. Refer link - <https://cars.tatamotors.com/service/owners/owners-manual>

For compatible list of phones, refer link: <https://cars.tatamotors.com/service/owners/phone-bluetooth-compatibility-with-car-infotainment-system>

#### Master /force Reset Process

If your infotainment system touch screen becomes unresponsive or shows some unusual behavior, then you can restart it to potentially resolve the issue. Follow some basic steps given below and you can restart the system.

To restart the infotainment system

1. Park the vehicle.
2. Hold the Steering wheel Mute button (long press) for more than 10 secs and then release the button as soon as the display goes blank.
3. The step above will trigger the infotainment system restart procedure. Wait until the system restarts.
4. When you Hold the Steering wheel Mute button for more than 15 sec, system aborts restart process and display turns ON.

#### **i** NOTE

- It is preferable to do one Ignition OFF to ON cycle after Master/Force



*reset to synchronize vehicle settings with the TATA Infotainment System.*

- *If the reboot does not work or master/force resets are required on a weekly or daily basis, vehicle shall be taken to dealership. There, the dealer can update your firmware or inspect the system for hardware problem.*
- *Force/Master reset keeps the stored data, such as call history, text message information, and previously paired phones as it is.*

### **SPEAKERS & TWEETER (if available)**

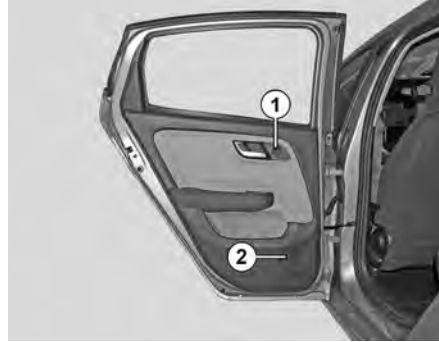

1. Tweeter
2. Speaker

Speakers and Tweeters are available in models with infotainment system. Provisions are given for music system and speakers on versions without infotainment system.

### **USB PORT (if available)**



Connect your pen drives to this socket for playing music tracks through the vehicle's music system.

## DASHBOARD AND FEATURES

### POWER SOCKET

The power socket will work when the ignition switch is in the “ACC” or “ON” position. This socket can be used to provide 12V (10A) power for electrical accessories.



For front passenger



For rear passenger

#### **i** NOTE

- Use of unapproved electrical accessories can cause damage to your vehicle's electrical system.
- Make sure that any electrical accessories you use are designed to plug into this type of socket and rating.

### ANTENNA



Antenna is located on the roof. Turn the antenna anticlockwise to remove it from the vehicle, if required.

### ROOF GRAB HANDLE

Grab handles are installed on the roof for all seats except for the driver's seat. These help the passengers to position themselves comfortably during the journey.

#### Option I



#### Option II

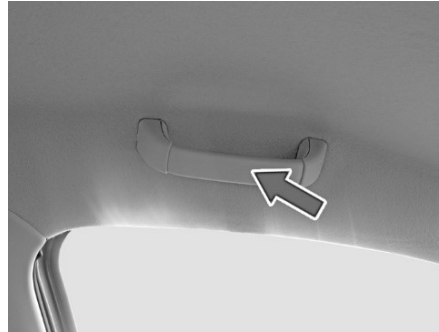

### ROOF LAMP

#### Option I

Interior roof lighting lamp is provided on the roof with inbuilt switch.



The switch has three positions:

**ON** - The lamp will turn 'ON' as long as the switch is in this position.



**DOOR** - In this position the lamp turns to 'ON' when either of the doors are opened. When the last door is closed, the lamp will turn 'OFF' with dimming. This helps

## DASHBOARD AND FEATURES

settling in the seat and inserting the key in the ignition switch.



When the key is turned to the 'IGN' position, the lamp goes 'OFF' immediately.

**OFF** - In this position, the lamp will remain 'OFF'.



### Option II

Interior roof lighting lamp is provided on the roof with inbuilt switch.



Press the button to turn the lamp 'ON'. It will remain 'ON' even when either of the doors are opened.

When the last door is closed, the lamp will turn 'OFF'.



### NOTE

*The Lamp will turn on as long as the ignition switch is in "ON" position.*

## BOOT LAMP (if available)



Boot lamp is provided in the rear luggage compartment to illuminate the luggage area.

It will switch on whenever any door or tailgate is open.

### SIDE INDICATOR LAMP



It is provided on the side fender.

It will turn ON when the turn signal indicator switch is ON and hazard warning switch is ON.

### FRONT LAMP

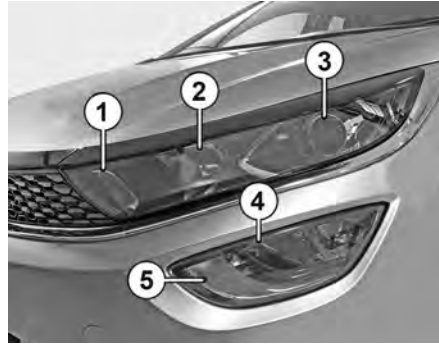

1. Position /Turn indicator lamp
2. High beam lamp
3. Low beam lamp
4. Front fog lamp (if available)
5. DRL (if available)

### TAIL LAMP

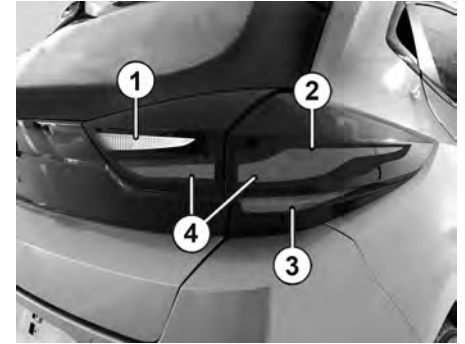

1. Reverse lamp (on LH lamp only)
2. Stop lamp
3. Turn indicator
4. Parking lamp

## DASHBOARD AND FEATURES

---

### **AMBIENT LIGHTS (if available)**

Interior ambient lighting comforts user by illuminating the vehicle interiors at defined locations. Single colored LEDs are fixed at various locations of the vehicle interiors.

### **Turning Ambient Lighting ON And OFF**

- Ambient Lights turn on in Blue color whenever parking light is turned to ON.
- Ambient Lights turn off whenever parking light is turned to OFF.

### **Ambient Lights (entry/exit)**

- Ambient Lights turn on in Blue color whenever roof lamp made active by removing the ignition key from key slot and opening any door.
- Once the opened door is closed, the Ambient lights dims off after approximately 25 seconds.
- If door is left open, ambient lights will turn OFF after set battery saver time

### **IRA (INTELLIGENT REAL-TIME ASSIST) CONNECTED CAR SERVICE**

Car is equipped with iRA - Connected car Technology which offers a host of features to the users through the "iRA - Connected car" Mobile Application (APP). The Vehicle is equipped with an Electronic Control unit which monitors & records the data from various vehicle systems like Engine, Transmission, Brake, Battery & other electrical systems. This data is then processed & used for providing the connected Car features (For details & list of features, please refer the connected car brochure provided to you along with this manual). (Refer the app tour section of the mobile app.)

The Connected Car module records the following information:

#### **Vehicle Telematics**

This includes the periodic transmission of data from other vehicle ECUs & Electronic systems like EMS, ABS, Air Bag, BMS, BCM etc. along with the geographical location of the vehicle.

### **Vehicle driving behavior**

This includes the location, speed, acceleration, trip details, charging etc.

### **Event based recording**

This includes data generated during specific events like vehicle collision, intrusion, un-authorized entry etc.

The Data collected through Connected Car module is used by Tata Motors Passenger Vehicle limited for various purposes, including, but not limited to, Providing Connected Car features through Mobile APP.

- Evaluation of Vehicle performance.
- Research & improvement of current & future vehicle designs.
- Troubleshooting & diagnostics of the vehicle.

TMPVL does not disclose the data recorded from your vehicle to any third party except:

- After obtaining a written consent from the Car Owner.
- Upon request from Law enforcing agencies and regulatory bodies.

- Used for research purpose without the Personal Verifiable information (anonymized).
- Used as defence of TMPVL in a Lawsuit.

### INDIRECT TIRE PRESSURE MONITORING SYSTEM (if equipped)

The Indirect Tire pressure Monitoring system (iTPMS) senses low tire pressure by comparing relative wheel speeds via wheel speed sensor of ABS system. As added safety your vehicle is equipped with indirect Tire pressure monitoring system, if one or more tires pressure decrease below the recommended value, the system warning light will be illuminated in instrument panel cluster with text message “**check all tire Pressure and Reset the TPMS system**”.

For the system to function properly it is driver’s responsibility to fill the recommended Tire pressure in all four wheels before resetting the iTPMS system successfully. This will be a reference point for system to indicate tire pressure warning correctly. Hence it is important to follow recommended iTPMS reset procedure. Resetting the iTPMS system in an incorrect manner may lead to erroneous results.

### iTPMS Reset Procedure

The driver can reset the iTPMS system by following below procedure:

1. Inflate all Tires to the OEM recommended Tire pressure.
2. Turn on vehicle & keep it stationary.
3. Use steering control buttons to enter into settings screen of instrument panel cluster, where iTPMS reset option will be visible.



4. Select the “iTPMS reset” option with tick button and arrow buttons can be used for navigation on Right steering

## DASHBOARD AND FEATURES

control buttons.

5. Confirm iTPMS reset input by clicking on OK, always ensure iTPMS reset is initiated only after all tires are inflated to recommended tire pressure.
6.  iTPMS system will complete its self-reset procedure in background once vehicle is getting driven between 40 - 120 kmph after reset is Initiated 20 minutes approximately.

### NOTE

*Resetting the TPMS function in an incorrect manner may lead to erroneous results. It is imperative that the function is reset only 'after' all tires are inflated to the OEM recommended tires/tire pressure.*

### How It Works?



When Tire pressure drops significantly below Recommended levels the "check all tire Pressure and reset the iTPMS system" Indicator comes ON with text message.

### What To Do?

1. Visually inspect all the tires for any damage.
2. Use the tire pressure gauge to check which tires have low pressure.



3. If a tire is observed to have air leakage or a puncture, please replace it with the spare tire. Please get the faulty tire rectified at the earliest to avoid any further damage.
4. Inflate ALL THE TIRES to recommended tire Pressure As specified on the driver door's label.



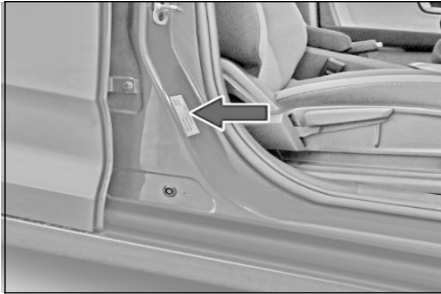

### iTPMS Reset

Any time you change or rotate one or more of your tires, you need to Inflate ALL THE TIRES to recommended tire pressure and reset the iTPMS system. Reset should not be initiated if spare tire (other than ground tire) is fitted on the vehicle.

1. Go to instrument cluster setting window.



2. Select settings through steering right side steering controls buttons.



3. Select iTPMS reset and confirm OK



4. The iTPMS warning blinks and iTPMS reset starts.



## DASHBOARD AND FEATURES

5. iTPMS reset option will grey out during vehicle driving conditions



iTPMS system will complete its self-reset procedure in background once vehicle is getting driven between 40 -120 kmph after reset is Initiated 20 minutes approximately, during this period system is not available to detect any low tire pressure.

### **i** NOTE

- iTPMS system provides the warning to the driver when tire pressure is low. iTPMS system cannot inflate the tire.
- As additional functionality one tire over inflation, Diagonal 2 tires over

*inflation and three tires over inflation is detected as puncture to remaining tires, with this “check all tire Pressure and reset the iTPMS system” Indicator comes ON with text message. User has to follow tire check and iTPMS system reset procedure as mentioned above.*

- *It is very rare but if two tires on Rear axle are deflated by same percentage then iTPMS might not detect this situation.*

### **i** NOTE

*iTPMS system is not the substitute for regular tire pressure check, be sure to check the tire pressure regularly. If the vehicle is driven at speeds less than 25 km/hr the iTPMS system may not operate correctly. Kindly ensure to use OEM recommended tire only of same make and size.*

## System Malfunction



iTPMS continuously monitors itself for any error, iTPMS warning lamp will appear on instrument panel cluster for 3 seconds after every ignition on during system self-check and disappear after self-check is complete and if system is healthy. If Malfunction is detected the iTPMS malfunction lamp (amber) on instrument cluster will blink for 3 seconds with chime for first and then will remain illuminated until fault is present in the system.

For every ignition reset iTPMS warning lamp will be ON and chimes and text message will reappear until fault is present in the system.

## DASHBOARD AND FEATURES



Kindly visit TATA Motors authorized EV service centre if iTPMS malfunction indication is ON continuously.

### Changing The Tire With iTPMS

If you have a flat tire iTPMS warning lamp and text message will get triggered, have a flat tire replaced/repared from authorized TATA EV service centre/tire shop After fitting the repaired tire kindly ensure all wheels are inflated with recommended tire pressure and reset the iTPMS system as specified in iTPMS reset procedure.

### Under Certain Condition iTPMS Warning Lamp Will Illuminate When Fault Is Not Present, These Conditions Include

- The non-Recommended tire fitted.
- If Vehicle is fitted with Spare Tire or non-recommended spare tire.
- Tires are installed with snow chain.
- Rough Terrain driving for excessive periods.
- Bending or mountain type terrain driving for excessive periods.
- iTPMS system will not indicate immediately if tire "blows out".
- If iTPMS system is not reset successfully after Tire Inflation, Tire rotation, Tire change and Tire Puncture/repair.
- If Wheel alignment and wheel balancing is not performed as per OEM specifications.

Tyre pressure variation detection after successful iTPMS system reset.

One tyre deflation	25 kmph above	Less than 10 minutes
2 tyre deflation	40 kmph above	Less than 60 minutes
3 tyre deflation	40 kmph above	Less than 60 minutes
4 tyre deflation	40 kmph above	Less than 60 minutes



### STOWAGE COMPARTMENT



1. Glove box
2. Driver side coin box
3. Utility pockets on front doors
4. Utility pockets on rear doors
5. Centre console
6. Stowage for rear passenger (if available)
7. Tailgate Compartment (Luggage)

## STOWAGE COMPARTMENT

### Glove Box



#### Opening and Closing

**To open-** Press the knob and open the glove box flap.

**To close -** Lift glove box flap upward until it engages.

#### **i** NOTE

*Make sure that glove box flap is closed while driving.*

#### Glove Box Illumination (if available)

The glove box lamp illuminates when the

glove box flap is opened.

#### **i** NOTE

*Make sure that glove box flap is closed while driving.*

#### Stowage Detail (if available)

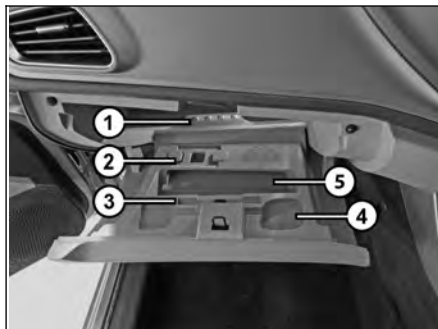

Following items can be stowed in glove box:

1. iPod
2. Visiting card
3. Pen holder
4. Cup holder

5. Mobile phone

#### Cooling Facility (if available)



On selected models glove box is provided with a cooling facility. It cools the glove box only when the front A/C is ON. Shut OFF the vent by rotating the knob, whenever cooling is not required.

## STOWAGE COMPARTMENT

### Driver Side Coin Box

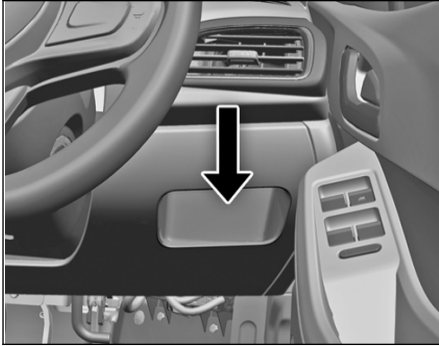

Stowage is provided on RH side of steering wheel for Coin, mobile and wallet.

### Utility Pockets on Front Doors

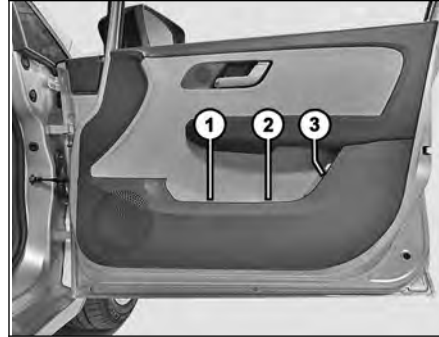

Utility pockets are provided on front doors and it can be used to keep following items.

1. Magazine / paper / books
2. Suitable water bottle
3. Umbrella

#### **i** NOTE

*Remove the water from umbrella and fold it properly before storing it in umbrella holder.*

### Utility Pockets on Rear Doors

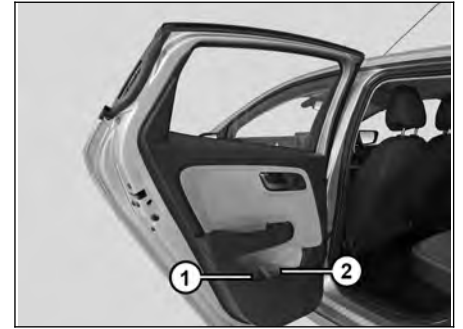

Utility pockets are available on rear doors and it can be used to keep following items.

1. Suitable water bottle
2. Magazine / paper / books

## STOWAGE COMPARTMENT

### Center Console

#### Stowage Below Arm Rest - Option I

A storage compartment is provided below the armrest for keeping phones, chargers etc.

To open the armrest pull the flap.



#### Stowage Below Arm Rest - Option II



Following items can be storage in Center console.

1. Pen holder
2. Cup holder

#### Stowage for Rear Passenger (if available)



Stowage for the rear passenger is available on rear side of floor console between the front passenger seats. It can be used to keep phone and small items.

#### **i** NOTE

*Applicable for models where rear vents is not provided.*



## STOWAGE COMPARTMENT

### GOGGLE STOWAGE



Place for keeping goggle is provided above the roof lamp.

### Tailgate Compartment (luggage)



Store the luggage in tailgate compartment. You can keep suitcase, bags, etc.

#### **WARNING**

- Distribute the items of luggage as evenly as possible.
- Position heavy loads towards rear seat and low down in the trunk as possible.
- Do not allow occupants to travel in the luggage compartment.
- 

- Do not place anything on luggage cover as it could obstruct driver's rear view. Also in case of an accident or sudden braking, it could cause an injury to occupants.

## STOWAGE COMPARTMENT

### HOOKS (if available)

#### Coat Hook

Coat hanger is provided for rear passenger on right side grab handle.

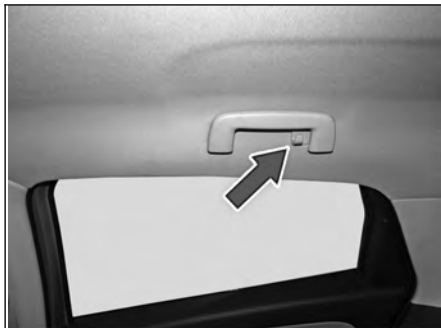

#### **i** NOTE

- *The coat hook is not designed to carry heavy objects or luggage items.*
- *Do not hang hard, sharp-edged or fragile objects on the coat hook.*

#### Collapsible Hook

Collapsible hook is provided for hanging small carry bags etc.



#### Carrier Hook

Carrier hook is provided for hanging small carry bags etc.



#### **i** NOTE

*Do not use these hooks for securing luggage like using nets etc. in the boot.*

### AIR DISTRIBUTION

The air is distributed through the vents in the passenger compartment as shown below:

The climate control regulates the temperature set in cabin based on user settings and it can be set in temperature settings.



## CLIMATE CONTROL

### AIR VENT

Air vents are available on the dash-board. The direction of air flow can be adjusted using sliders on the respective vents.



*Centre Air Vents (Front)*



*Side Air Vents (Front)*

### REAR AC VENTS (if available)

Rear AC vents are available between two front seats. It can be switched 'ON' provided that front AC is switched 'ON'.

It can be switched 'ON/OFF' by rotating knob.

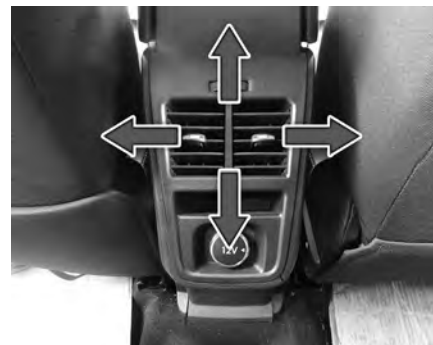

### HVAC CONTROLS (if available)

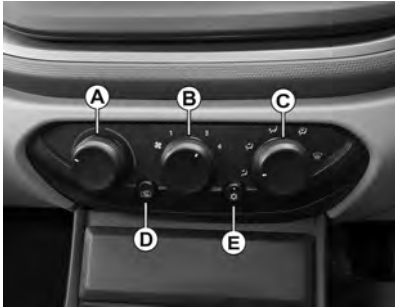

- A. Temperature Control
- B. Blower Speed Control
- C. Air Distribution Control
- D. Fresh / Recirculation air mode
- E. AC ON/OFF Switch

### Temperature Control



The temperature control knob allows you to adjust the temperature. The temperature can be increased by rotating the knob towards the red segment (clockwise) and decreased by rotating it towards the blue segment (anti-clockwise).

### Blower Speed Control







This is to turn 'ON' the blower and select desired blower speed.

## CLIMATE CONTROL

### Air Distribution Control



Air distribution control

	Directs air through the center and side air vents
	Directs air through the center, side and foot well vents
	Directs air through the foot well air vents
	Directs air through the defroster & foot well vents (Default fresh air mode)
	Directs air through the defroster vents (Default fresh air mode)

### Fresh / Recirculation Air Mode

Press the switch to activate / deactivate air recirculation mode.



Press to 'ON' or 'OFF'

#### Recirculation Mode: (indicator Light 'ON')

Air in the passenger compartment re-circulates. No fresh air enters the compartment.



Always use when:

- Driving on a dusty road or through tunnel.
- On signals or slow traffic to avoid traffic pollution.
- Maximum cooling is required

#### Fresh Air Mode: (indicator Light 'OFF')

Fresh air is drawn into the vehicle.

Always use when:

- Discomfort is felt or windows are fogging up.
- Using  or  air flow modes during demist / defrost.
- Using normal heating mode.

#### AC ON/OFF



Press the button to switch ON/OFF the AC. The indicator lamp in the button will light up when AC is ON.

***i* NOTE**

*The AC can be switched to 'ON' only if the blower is 'ON' and engine is running.*

When AC is switched to 'ON', engine idling RPM increases marginally to adjust the AC compressor load.

When desired temperature is achieved Ac compressor will self displace optimum refrigerant flow.

***i* NOTE**











- *Water may drip from the underside of the vehicle when it is in cooling mode. Traces of water on the ground are normal and are not a sign of leakage or malfunction.*
- *Ventilate the vehicle for a brief period during warm weather. This will speed up the cooling process and the desired vehicle interior temperature will be reached quickly.*
- 

- *Do not cover the air vents or air intake grilles in the vehicle interior.*
- *If the AC is not used for a long period, such as during winter, it may not give the best performance when you start using it again. Operate the AC at least once a month to maintain optimum performance.*
- *When you start the vehicle after a long duration (more than 15 days), follow the procedure for better AC performance:*
  - *Start the vehicle and allow the engine to idle for 2-3 minutes. AC should be off in this period.*
  - *Switch the AC on and run it for another 2~3 minutes while the engine idles. This circulates the refrigerant and oil to lubricate the internal parts of the air-conditioning system.*

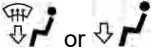
## CLIMATE CONTROL

### Functions and Setting

Here are the recommended basic settings of the control elements of air conditioning system for the respective operating modes. These may vary depending on individual requirements and weather conditions:

Settings	Control Knob Position			Button Position	
Functions	A. Air Temperature 	B. Blower Speed 	C. Air Flow Direction 	D. Fresh / Recirculation air mode 	E. AC ON / OFF 
<b>Normal heating</b>	Desired temp.	2nd or 3rd dot		Fresh air mode.	Switched OFF
<b>Quick heating</b>	To the extreme right up to the stop	To MAX speed and then 2nd or 3rd dot		Briefly switch ON to Recirculation mode then Fresh air mode	Switched OFF
<b>Normal Cooling</b>	Desired temperature	1st to 3rd dot		Recirculation mode	Switched ON
<b>Quick Cooling</b>	To the extreme left up to the stop	To MAX speed and then 2nd or 3rd dot		Recirculation mode	Switched ON
<b>Demisting</b>	Desired temperature	2nd or 3rd dot		Fresh air mode (Default)	Switched ON (Default)
<b>Defrosting</b>	To the extreme right up to the stop	To MAX speed		Fresh air mode (Default)	Switched ON (Default)



## ELECTRONIC TEMPERATURE CONTROL (ETC) (if available)

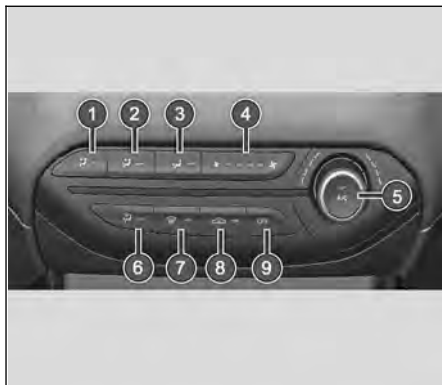

1. Air Distribution Mode -Center and side
2. Air Distribution Mode- center, side and foot well
3. Air Distribution Mode -foot well
4. Blower Speed Control
5. AC ON/OFF Switch
6. Air Distribution Mode- defroster & foot well
7. Air Distribution Mode - Defroster

8. Fresh / Recirculation air mode
9. OFF Switch

### 1. Air Distribution Mode -center And Side

This is to select the air distribution pattern directs air through the center and side air vents.



### 2. Air Distribution Mode Center, Side And Foot Well

This is to select the air distribution pattern directs air through the center and side and foot well air vents.





### 3. Air Distribution Mode -foot Well

This is to select the air distribution pattern directs air through the foot well air vent.



### 4. Blower Speed Control

Press the Blower Speed control down button  to decrease the blower speed and press the blower speed control up button  for increase the blower speed.

### 5. Ac On/off

Press the button to switch ON/OFF the AC. The indicator lamp in the button will light up when AC is ON.



#### NOTE

*The AC can be switched 'ON' only if the blower is 'ON' and engine is running.*

When AC is switched 'ON', engine idling RPM increases marginally to adjust the AC compressor load.

When desired temperature is achieved Ac compressor will self-displace optimum refrigerant flow.

#### NOTE

- *Condensate may drip from the underside of the vehicle when it is in cooling mode. Traces of water on the ground are normal and are not a sign of leakage or malfunction.*
- *Ventilate the vehicle for a brief period during warm weather. This will*

## CLIMATE CONTROL

*speed up the cooling process and the desired vehicle interior temperature will be reached quickly.*

- *Do not cover the air vents or air intake grilles in the vehicle interior.*
- *If the AC is not used for a long period, such as during winter, it may not give the best performance when you start using it again. Operate the AC at least once a month to maintain optimum performance.*
- *While you start the vehicle after a long duration (more than 15 days), follow the procedure for better AC performance:*
  - *Start the vehicle and allow the engine to idle for 2-3 minutes. AC should be off in this period.*
  - *Switch the AC on and run it for another 2~3 minutes while the engine idles. This circulates the refrigerant and oil to lubricate the internal parts of the air-conditioning system.*

### 6. Air Distribution Mode- Defroster & Foot Well

This is to select the air distribution pattern directs air through the foot well air vent.



### 7. Air Distribution Mode - Defroster

This button directs the main airflow towards windscreen for faster defrosting. (It also overrides any mode selection you may have made.)



#### **i** NOTE

- *For your safety make sure you have a clear view through all the windows before driving.*
- *When “Air Distribution Mode - Defroster & Foot Well” or “Air distribution mode - Defroster” is pressed, system may switch on AC and move to fresh air for optimum demisting/defrosting*

### 8. Fresh / Recirculation Air Mode

Press the switch to activate / deactivate air recirculation mode. Press to ‘ON’ or ‘OFF’



### 9. Off Button

Press the OFF button to switch the system ‘OFF’.



### FULLY AUTOMATIC TEMPERATURE CONTROL (FATC) (if available)

#### General Description

FATC system controls the in-cabin temperature of the vehicle automatically and provides maximum passenger convenience regardless of outside weather conditions.

#### Display Unit



FATC display is shown on main display screen.

FATC functions can be controlled using both the FATC control panel and the touch screen display.

Whenever the user presses any push button or turns the rotary knob, then the display unit will show the relevant Climate Information.

Also, when the display is not in climate mode then climate information will be displayed on the all-time display available on the top bar.

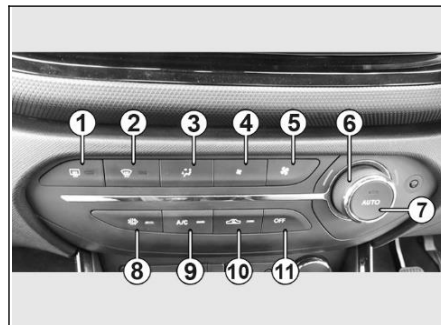

1. Rear window demister button
2. Maximum Defrost button
3. Air Distribution mode
4. Blower speed down control
5. Blower speed up control
6. Temperature control knob
7. Auto ON selection button

8. Express cooling
9. AC ON / OFF button
10. Fresh Air / Recirculation button
11. OFF button

#### FATC Controls

##### Rear Window Demister Button

This button turns the rear window demister ON or OFF. The system will be deactivated after 15 min of continuous operation.



##### Max Defrost Button

This button directs the main airflow towards windscreen for faster de-frosting. (It also overrides any mode selection you may have made.)



When you turn off the button, the system returns to its former settings.

#### NOTE

*For your safety make sure you have a clear view through all the windows before driving.*

## CLIMATE CONTROL

### Air Distribution Mode

In AUTO mode, the FATC system will regulate the mode automatically. However, user override is possible with the use of MODE button to select the desired airflow mode.



Each time you press the MODE button, the display shows the mode selected.

	Directs air through the center and side air vents
	Directs air through the center, side and foot well vents
	Directs air through the foot well air vents
	Directs air through the defroster & foot well vents (Default fresh air mode)
	Directs air through the defroster vents (Default fresh air mode)

### Blower Speed Control Button

Press the Blower Speed control down button to decrease the



blower speed.

### Blower Speed Control Up Button

Press the Blower Speed control up button to increase the blower speed.



### Temperature Control Knob



Turning the temperature control knob clockwise increases the temperature of the air. The desired temperature will be increased by steps of 0.5°C. User can select temperature range from 18°C to 30°C. Turning the knob in the anticlockwise direction reduces temperature.

When you set the temperature to its lower limit (Lo) or its upper limit (Hi), the system runs at full cooling or heating only. It doesn't regulate the interior temperature.

### Auto ON Selection Button



To put the automatic climate control in fully automatic mode:

Press the 'AUTO' button.

- Set the desired temperature by turning temperature control knob. The display will show all the functions during 'AUTO' mode.
- The system automatically selects the proper mix of conditioned and / or heated air that will, as quickly as possible, raise or lower the interior temperature to your preference.
- When you set the temperature to its lower limit (Lo) or its upper limit (Hi), the system runs at full cooling or heating only. It does not regulate the interior temperature.

### Semi-automatic Operation

You can manually select various functions of the climate control system when it is in fully automatic mode. All other features remain automatically controlled. Making any manual selection causes the word 'AUTO' in the display to go OFF and the overridden setting is displayed. System will remain in semiautomatic mode till 'AUTO' is pressed again.

### Xpress Cooling (if Available)

This helps cabin to reach to comfort temperatures quickly by optimally setting the air conditioning to maximum cooling. Also, if required, the driver window will roll down to flush the hot air from inside the cabin. XPRESS Cooling can be turned On/Off by Xpress switch or by a soft key from Head Unit.

### Functionality

Once Xpress cooling button is pressed, system optimally calculates if the car is soaked in sun and takes the driver's window roll down to flush out the hot air from cabin. Also, air conditioning system will be set to maximum cooling and maximum fan

speed for short duration.

Once cabin has been sufficiently flushed, the system will announce to take driver window's roll up which can be taken up using window winding switch.

Driver side window may roll down, if:

- The cabin temperature is more than outside temperature.
- If it is not raining.
- Vehicle Speed is less than 40 kmph.



Further, after sufficiently cooling the cabin, the Xpress cooling function will auto switch off and revert back to customer pre-selected settings.

Express cooling functionality is used to improve the HVAC system performance in case of cabin temperature being considerably greater than outside air temperature. The system will be deactivated automatically after 500 sec of continuous operation.

### NOTE

*The Express Cool function can only be turned ON if the Ambient temperature is above 18 degree Celsius.*

### AC ON / OFF Button

Press the AC ON/OFF button  to turn the air conditioning ON or OFF. The AC icon activated on the display when the AC is ON.

### Fresh Air / Recirculation Button

When the recirculation button  or LED is switched 'ON', air from the vehicle's interior is sent throughout the system.

When the recirculation button is switched to 'OFF', air from outside enters into the cabin (fresh mode). Whenever discomfort is felt, switch to fresh air mode.

### NOTE

*The outside air intakes for the climate control systems are at the base of windshield. Keep this area clear from*

## CLIMATE CONTROL

*leaves and other debris.*

Use recirculation mode for faster heating and cooling. However, keeping the system in recirculation mode - particularly when the AC is in OFF - can cause fogging of windows.

### **i** NOTE

*When reverse gear is selected, air inlet may switch to recirculation mode if it is in fresh air mode, to prevent exhaust fumes from entering the cabin.*

### **“OFF” Button**

Press the OFF button to switch the system 'OFF'. OFF will be displayed on the infotainment screen.



### **FATC Sensors**

FATC system is fitted with three sensors.

1. A solar sensor on windshield glass at the center.



2. In-car sensor on HVAC control panel.



3. Outside Ambient Temperature (OAT) sensor located under the front bumper grill.

### **i** NOTE

- *Do not cover or spill any liquid on sensors.*
- *Do not cover sensor, this may cause the sensor to malfunction. This may lead to FATC not functioning to desired level.*





### **Quick Cooling**

If your vehicle is parked under the sun, you can cool it down fast by following the steps given below:

1. Start the engine.
2. Turn the A/C on and make sure the temperature control is set to the lowest. In case of FATC set temperature to 'Low' mode.
3. Set the blower to maximum speed
4. Slightly open the windows and direct the vents towards the face.
5. When the interior has cooled down to a comfortable level, close the windows and set the required temperature, with recirculation mode ON.

## CLIMATE CONTROL

### Functions and Settings

Functions	Control Knob Position		Button Position						
	(6)	(7)	(1)	(2)	(3)	(4)	(5)	(8),(9)	(10)
<b>Normal heating</b>	Desired Temp	Auto	OFF	OFF	OFF	Desired Speed	Desired Speed	A/C ON	Fresh Air
<b>Quick heating</b>	To the extreme right until temp 'HI'	OFF	OFF	OFF		NA	Max speed	ON	Fresh Air
<b>Normal Cooling</b>	Desired Temp	Auto	OFF	OFF		Desired Temp	Desired Temp	A/C ON	Recirculation
<b>Quick Cooling</b>	To the extreme left until temp 'LO'	OFF	OFF	OFF		NA	Max speed	ON	Recirculation
<b>Demisting</b>	To the right up, to the desired temperature	OFF	As desired	ON		Desired speed	Desired speed	A/c ON	Fresh air
<b>Defrosting</b>	To the right up, to the desired temperature	OFF	OFF	ON		NA	Max Speed	ON/OFF	Fresh air



**Fully Automatic Temperature Control (FATC) Adjusted by Infotainment System**



*AC set in auto mode*



*Blower speed*



*FATC settings on head unit*



*FATC settings on Head Unit Xpress Cooling*



### PRE DRIVING CHECKS

#### Make Sure That

- Windshield, windows, mirrors, lights, and reflectors are clean and unobstructed.
- Tool kit, jack & handle, warning triangle, owner's manual, first aid kit and vehicle documents are available and stored at their locations.

#### **WARNING**

Do not put any mat on the floor carpet near control pedals area.

- All doors, engine bonnet and tail gate are securely closed and latched.
- All occupants should always wear seat belts or suitable CRS as applicable while travelling.
- Objects, luggage or loads are secured correctly against slipping or tipping.
- Rear seat is securely latched.
- There is sufficient fuel for the trip.

### Daily Check

- Tyres for unusual wear, cracks or damage and embedded foreign material such as nails, stones, etc.
- Traces of fluid and oil below vehicle

#### **NOTE**

*Water dripping below the car is normal. This is due to the usage of air conditioning system.*

- All lamps, wipers, wiper blades and horn for proper operation.
- All switches, gauges and tell tales are working properly.

### Adjust

- Seats, head restraints and steering wheel position.
- Adjust all the mirrors before you start the car.

### Weekly Check

- Engine oil level
- Coolant level
- Brake fluid level
- Windshield washer fluid level
- Battery electrolyte level
- Fuel level

#### **NOTE**

*Tyre pressure should always be measured in cold conditions. Do a check of the tyre pressure and condition after every 15 days, including the spare tyre.*

## STARTING AND DRIVING

### DRIVING TIPS

Fuel consumption, engine, transmission, brake and tyre wear are mainly affected by the below factors:

- Operating conditions of your vehicle
- Your personal driving style

### Operating Conditions

- Avoid frequent starts and stops as these actions increase the fuel consumption of the vehicle.
- Always ensure correct tyre pressure.
- Do not carry any unnecessary weight.
- Regularly service your vehicle and adhere to the recommended service maintenance schedule.

### Personal Driving Style

- Do not press the accelerator pedal when starting the engine.
- Do not warm up the engine when the vehicle is stationary.
- Always adapt your driving style to suit the prevailing road, weather conditions, and maintain a safe distance from the vehicle in front. Drive care-

fully.

- Avoid frequent, sudden acceleration and braking.
- Select appropriate gear according to varying speeds and load conditions.

### NOTE

*Do not rest your foot on the clutch pedal while driving.*

- Switch 'OFF' the engine in stationary traffic or at signals.
- Keep an eye on the vehicle's fuel consumption.
- Safety systems are merely aids designed to assist driving. You are responsible for the distance between the vehicles in front, for vehicle speed and anticipating braking in good time.

### WARNING

- You could lose control of your vehicle if you try to adjust the driver's seat, head restraint, mirror, steering wheel and fasten the seat belt while

driving. There is a risk of an accident.

- Do not rest your hand on the shift lever during driving; Pressure transmitted from your hand may result in premature wear of the transaxle internal gear shift mechanism.
- Press the clutch fully while shifting the gears. The reverse gear should be engaged only when the vehicle is stationary. Transmission may get damaged by trying to shift into reverse gear while the vehicle is moving. Wait for 5 seconds after declutching to ensure smooth engagement of the reverse gear or shift into one of the forward gears for a moment while clutch is pressed fully. This will avoid grinding of reverse gear while shifting.

### Recommended Fuel Economy Speeds

Gear	Diesel	Petrol
	Speed (kmph)	Speed (kmph)
1	15	20
2	30	35
3	50	55
4	65	75
5	85	95

### Good Driving Practices

- Slow down before you shift to a lower gear. This helps the engine to keep a lower rpm and result in less wear and tear of the engine components.
- Avoid frequent brake application which can cause overheating of brakes.
- Slow down the vehicle when you drive in cross winds to get better control over the vehicle.
- Avoid high speed when cornering or turning.
- Press the clutch fully while shifting

gears.

- Make sure that vehicle is completely stationary before you attempt to shift in reverse gear.
- Drive slowly on wet roads.
- You can get extra braking from the engine by shifting to a lower gear. This can help you to maintain a safe speed and prevent your brakes from overheating specially while going down a hill.

### Tips for Obtaining Better Fuel Efficiency

- Always maintain the specified tyre pressure during fuel top-ups and also before a long trip. Vehicle running with low tyre pressure will consume more fuel than the one running with specified tyre pressure.
- Keep the vehicle clean. Get rid of the unwanted stuff lying in the boot etc., to reduce weight.
- Regularly inspect your vehicle for any leakages, worn out wires, damaged by rat bites etc.

- Always follow periodic & regular service schedule of the vehicle.
- In places with high dust content. Clean the air filter element at every 5000 km.
- Anticipate the road conditions and drive in a smooth manner.
- Do not accelerate excessively when you are in lower gears (1st or 2nd). Be gentle on the accelerator when you are in traffic. In lower gears, opening up the throttle will increase the engine rpm while keeping the vehicle at lower speeds. This reduces the fuel efficiency of the vehicle.
- Be in the maximum possible higher gear at a given speed. This reduces the engine operating speeds which means the engine is running at lower rpm (Revolutions per Minute) for the same vehicle speed. Lesser the number of engine revolution lesser the fuel burned.
- Avoid harsh braking.
- Maintain healthy driving habits & while decelerating, do coasting in gear and not in neutral or with clutch pedal

## STARTING AND DRIVING

pressed.

- Use the car AC only when you require. For cooling, keep the blower speeds low, as at higher blower speeds, the AC consumes more electric power which is ultimately drawn from engine by burning fuel.
- Avoid unnecessary extra electrical loading on the car.
- Stop the engine wisely at traffic signals. Switch 'OFF' the engine at the traffic signal only if the stop-page time is high (typically more than 30 sec).
- When you drive on highways, close all the windows. This reduces the drag on the vehicle and improves fuel efficiency.
- Do not over speed. Follow the speed limits. With increasing speed, the engine rpm increases to overcome external air resistance and this reduces fuel efficiency.

### Running-in Period

The purpose of running in a car is to give time for the mechanical parts to settle so that they work efficiently. This involves gentle acceleration and not revving the engine too much. This is done by changing gears early for the first 1,500 – 1,800 km. This will increase the life of the engine.

The more you look after the engine when it is new, the more satisfied you will be with its performance in the future.

Do not exceed the following road speeds during running in period.

Gear	Diesel	Petrol
	Speed (kmph)	Speed (kmph)
1	15	20
2	30	35
3	50	55
4	65	75
5	85	95

Avoid heavy loads, e.g. driving at full throttle, during this period. Change gears judiciously.

### NOTE

*Avoid excessive revving up of engine rpm. Do not keep engine at idling for long duration.*

### SEAT ADJUSTMENTS

#### Front Seat Adjustments

Following seat adjustments can be carried out manually.

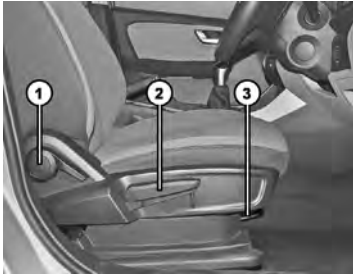

1. Backrest recliner adjustment lever
2. Seat height adjustment lever (if available)
3. Seat forward / rearward adjustment lever

#### WARNING

Do not adjust the driver's seat while driving. Adjusting the seat while driving could cause the driver to lose control of

the vehicle.

#### Seat Backrest Angle Adjustment

To change the seat back rest angle, lean forward slightly and pull up the lever (1). Adjust seat backrest until it reaches desired comfortable position. Make sure that lever returns to its original position and seat is securely latched.

#### NOTE

*Adjust the seat backrest until your arms are slightly angled when holding the steering wheel*

#### WARNING

Do not travel in a moving vehicle with the seat backrest in an excessively reclined position as this can be dangerous.

#### Seat Height Adjustment (if available)

To raise the seat, pull and continue pumping the lever (2) in the upward direction until the seat is at the desired height.

To lower the seat, pump the lever downward until the seat is at desired height.

#### Seat Forward/rearward Adjustment

Lift lever (3) and slide the seat forward or to the rear. Release lever and make sure that seat is securely latched.

#### NOTE

*Adjust the driver seat position in such a way that the driver will be able to operate the control pedals comfortably.*

#### Head Restraint (if available)



Adjust the head restraint so that it is as

## STARTING AND DRIVING

close to the head as possible and the center of the head restraint supports the back of the head at eye level. This will reduce the risk of injury to the head and neck in the event of an accident or similar situation.



### Correctly adjusted

The head restraint is at the correct height and close enough to the back of the head to help prevent injury.

### Incorrectly adjusted

The head restraint is at the correct height but not close enough to the back of the head.

### Incorrectly adjusted

The head restraint is at the wrong height and also not close enough to the back of the head.

## ⚠ WARNING

Do not drive the vehicle without the seat head restraints. Head restraints are intended to help reduce injuries during an accident.

### Front Passenger Seat Sensor

An occupant detection sensor is installed in the front passenger seat to detect whether the seat is occupied or not and if

occupied, it will activate the seat belt reminder warnings. The sensor does not have any control on the deployment of airbags.

## ⚠ WARNING

Any modification in the seat material or addition of seat cover may damage or affect the performance of the sensor.

### Rear Seats



### Rear Seat Folding (Complete seat 100%)



To fold the seat:

- Press the backrest release knobs provided on both sides at the same time.



## STARTING AND DRIVING



- Fold the backrest seat forward. Move the driver and front passenger seat forward if necessary.



### **WARNING**

- If the rear bench seat and seat backrest are not latched properly, they could fold forwards during hard braking or in the event of a collision.
- The vehicle occupant would thereby be pushed into the seat belt by the rear bench seat or by the seat backrest. The seat belt can no longer offer the intended level of protection and could even cause injuries.
- Objects or loads in the trunk cannot be restrained by the seat backrest.

- There is an increased risk of injury.
- Before every trip, make sure that the seat backrests and the rear bench seat/rear seat are engaged and securely latched.

## STARTING AND DRIVING

### REAR VIEW MIRRORS

#### Inside Rear View Mirror (IRVM)

To adjust the mirror move the mirror up, down or sideways manually to obtain the best rear view.

When you drive at night, set the selector tab to select anti-glare mode (if available) to reduce glare from the headlights of vehicles behind you.



#### **i** NOTE

*Use antiglare position only when necessary, as it reduces rear view clarity.*

#### Outer Rear View Mirrors (ORVM)

You can adjust the outer rear view mirrors manually (By hand) or remotely by knob. Adjust the outside rear view mirrors to desired position.

#### **i** NOTE

*Objects visible in mirror are actually closer than they appear. Always make sure of the actual distance from the road users traveling behind by glancing over your shoulder.*

#### Motorized ORVM Adjustment (if available)



The switch to adjust the motorized mirrors is located on the driver's door. You can adjust the mirrors when the ignition switch is in the "ACC" or "ON" position.

#### To Adjust The Mirrors:

1. Move the mirror selection switch to L (for left side) and R (for right side) to select the mirror you wish to adjust.
2. Use the four positions of the knob to adjust the rear view mirrors to required position.



**Manual ORVM Adjustment (if available)**



You can adjust the outer rear view mirrors manually.

### **⚠ WARNING**

Do not adjust the mirror while driving. Adjusting the mirror while driving could cause the driver to lose control of the vehicle.

## **ORVM FOLDING (as applicable)**

### **Option 1: Manual Folding**

ORVMs can be folded or unfolded manually. This is applicable only for vehicles which are not equipped with motorized folding provision.

### **Option 2: Auto Folding by Smart Key**



When you lock the vehicle, ORVMs will be folded automatically.

When you unlock the vehicle, ORVMs will be unfolded automatically.

In case of repeated usage, Mirror Folding/Unfolding will stop functioning and will

## STARTING AND DRIVING

be re-activated after delay of 2 mins. During that period avoid repeated pressing of Switch.

### Option 3: Auto Folding by Knob



To fold / unfold the ORVMs, keep the Selector switch in center position (i.e. neither 'L' nor 'R, position) and then toggle down. This will operate when the ignition switch is in the "ACC" or "ON" position.

### SUN VISORS (if available)



The sun visors can be pulled down to block the glare coming through the windshield.

To block the glare from side windows, pull down the sun visor and release it from retainer. Swing the sun visor to the side.

### Vanity Mirror (if available)

Vanity mirror is provided on the back of the front passenger side sun visor.

### ELECTRIC POWER ASSISTED STEERING (EPAS)

Your vehicle is equipped with electric power assisted steering system. The EPAS system makes steering the vehicle easier with less effort.

In EPAS system, the steering effort becomes heavier as the vehicle speed increases and becomes lighter as the vehicle speed decreases for better control of the vehicle at different vehicle speeds.

If the engine is 'OFF' or if the EPAS system becomes inoperative, the vehicle still can be steered with more steering effort.

This EPAS system is available with the following assist features

1. Speed sensitive assist control
2. Active return control

#### **i** NOTE

- A click noise may be heard from the EPAS relay after the ignition switch is turned ON or OFF position.

### STEERING WHEEL ADJUSTMENT

- *The steering wheel may not un-lock normally in some cases when ignition key turned 'ON' or 'ISS' button pressed. If this hap-pens, turn the steering wheel to the right or left slightly to unlock the steering wheel while turning the ignition key or pressing ISS button.*
- *Contact the nearest TATA authorized service center if in case of the above scenarios.*

will illuminate on the instrument cluster. The steering wheel rotation may become difficult to control or operate.

#### **WARNING**

Below are the symptoms of the system malfunction. Then, take your vehicle to the nearest TATA MO-TORS service center and have the EPAS system checked as soon as possible.

- The EPAS warning light does not illuminate.
- Engine noise may be heard when the vehicle is driven at low speeds.
- If the EPAS system does not operate normally, the warning light 



You can adjust the steering wheel position to suit your convenience.

The release lever is located offset to the steering column.

#### **To Adjust the Steering Wheel**

1. Adjust the seat to a comfortable position.
2. Push "Tilt lever" completely down to unlock the steering column.
3. Adjust the steering wheel to the desired position.
4. Pull release lever up completely to lock

## STARTING AND DRIVING

the steering column.

5. Make sure that steering wheel is securely locked by checking up and down direction.

### **i** NOTE

*When adjusting the steering wheel, make sure that:*

- *You can operate control pedals without any obstacles.*
- *You can see all the displays in the instrument cluster clearly.*

### **⚠** WARNING

Before you start the car, make sure the steering wheel position is locked. Do not unlock or adjust the steering wheel while the vehicle is in motion.

### **i** NOTE

- *The steering effort can suddenly increase, if the operation of the EPAS system is stopped to prevent serious accidents when it detects mal*

*function of the EPAS system during self-diagnosis.*

- *When steering for a prolonged period, the steering effort will increase to prevent overheating and damage to the steering system.*

## STEERING LOCK AND IGNITION SWITCH (if available)



The ignition switch has the following four positions:

**LOCK** - This is the normal parking position. Key from lock can be re-moved in this position only.

“LOCK” position prevents normal use of the steering wheel after the key is removed.

To release the steering lock, put the key in the slot and turn it clockwise to one click (ACC).

**ACC** - Accessories such as the infotainment system can be operated, but the engine remains 'OFF'. Steering gets unlocked.

**ON** - This is the normal operating position. All electrical systems are 'ON'.

**START** - Turn the key further clock-wise to the START position, (spring loaded) to start the engine. As soon as the engine starts, release the ignition key, which returns to ON position. While cranking, all accessories will be momentarily 'OFF'.

### Illuminated Key Ring (if available)

When the vehicle is unlocked, the illuminated key ring glows. This helps to locate ignition switch in the dark.

## STARTING AND STOPPING (without PEPS)

### Starting the Engine

Make sure that parking brake is engaged and vehicle is in neutral gear.

Press the clutch pedal fully and crank the engine. Do not press the accelerator pedal when starting the engine.

#### NOTE

*The Starter protection system fitted in this vehicle does not allow you to crank the engine  until you fully press the clutch pedal.*

Release the key as soon as the engine starts. Repeat if engine does not start.

#### NOTE

- The Starter protection system switches off the starter when it is continuously cranked for more than 10 secs. In such a case, get the key back to 'OFF' position & wait for 30*

*secs.*

- For vehicle equipped with turbocharger, after you start the engine, run the engine at idle speed for 30 seconds. Do not press accelerator pedal while starting the engine to avoid damage to the turbocharger.*

### Starting Off

To start off, press the clutch pedal fully and shift into 1st gear.

After releasing the parking brake, gradually release the clutch and slowly press the accelerator.

#### NOTE

*When shifting or starting off, do not race the engine. Racing the engine can shorten engine life and affect smooth shifting.*

### Stopping the Vehicle

For vehicle equipped with turbo-charger, turn the key to 'ACC' position to switch off

## STARTING AND DRIVING

the engine. Before switching off the engine, run the engine at idle speed for 30 seconds and then switch off. This will allow the engine oil to lubricate the turbocharger, till its speed is fully reduced and also allow the unit to cool down.

### **WARNING**

- Do not switch off the ignition while driving.
- For vehicle equipped with turbocharger, do not switch the engine off when it is running at high speed. This will lead to premature turbocharger bearing wear.
- If you switch off the ignition while driving, safety-relevant functions are only available with limitations, or not at all. This could affect the power steering and the brake boosting effect. You will require considerably more effort to steer and brake. There is a risk of an accident.

## STARTING AND STOPPING (PEPS) (if available)

### Engine Passive Start/stop



Start/Stop switch is provided on the dashboard towards the right side of steering wheel.

### Start Stop Button

The start/stop button or Push to Start Button is a main component of Passive (Engine) Start and Stop system. It is used to control ACC, IGN outputs as well as to start and stop the engine.



### **i** NOTE

- If smart key is inside the vehicle and on pressing start stop switch, if start stop switch green LED blinks more than 10 sec. duration then contact authorized TATA MOTORS dealer.
- If ESCL (Electronic Column Steering Lock) is not unlocked properly, then vehicle doesn't go into ACC mode.

### ENGINE PASSIVE START - CONDITIONS

#### Single Press Start

1. Bring the smart key with you and sit in the driver seat.
2. Press the clutch pedal and then press the start/stop switch.
3. Green colour LED on start/stop button will turn ON.
4. Once engine is started successfully, the green colour LED on start/stop button stays ON.

#### Two Step Start

##### Step 1

1. Have the smart key with you and sit on the driver's seat.
2. Press the start/stop button without pressing clutch pedal.
3. Amber colour LED on start/stop switch turns ON.
4. Engine will remain OFF and all electrical equipment and infotainment system can be used. Steering is unlocked.



#### Emergency Start

If the engine is switched from ON to OFF and start/stop button is pressed with clutch pressed within 5 seconds, engine gets cranked.

### **i** NOTE

*If ESCL (Electronic Column Steering Lock) is not unlocked properly, then Engine will not get cranked.*

#### Backup Start

To start the engine when smart key battery voltage is low, the user needs to press start/stop button two times with an interval of 2.5 seconds after pressing the clutch with valid smart key near immobilizer antenna (in Centre Console).

## STARTING AND DRIVING

### Step 2

1. Press the clutch pedal and then press start/stop button to start the engine.
2. Green colour LED on start/stop button will turn ON.
3. Once engine start successfully, green colour LED on start/stop switch will remain ON.

### Three Step Start

#### Step 1

1. Have the smart key with you and sit on the driver's seat.
2. Press the start/stop button without pressing clutch pedal.
3. Amber colour LED on start/stop button will turn ON.
4. Limited information will be displayed on instrument cluster and steering will be unlocked. Engine remains OFF.

#### Step 2

1. Press the start/stop button without pressing clutch pedal again.
2. Green colour LED on start/stop button will turn ON.

3. Engine will remain OFF but all electrical equipment and infotainment system can be used.

#### Step 3

1. Press the clutch pedal and then press start/stop button to start the engine.
2. Green colour LED on start/stop button will turn ON.
3. Once the engine is started successfully, the green colour LED on start/stop button stays ON.

## ENGINE PASSIVE STOP - CONDITIONS

### Single Press Stop

- IGN is ON and engine is running.
- Press the start/stop button with or without clutch.
- ACC and IGN turns OFF.
- LED on start/stop switch turns OFF.

### Single Long Press Stop

- IGN is ON and engine is running.
- Vehicle is in running condition i.e. wheel rpm >10 RPM or wheel sensor faulty.
- Press the start/stop button for more than three seconds.
- IGN returns OFF, ACC remains ON.
- Amber colour LED on start/stop switch turns ON.

### WARNING

When vehicle is in OFF mode (ACC, IGN and Crank OFF) and user tries to lock the vehicle from outside by press

ing any door handle switch and if PEPS detects that the smart key is left inside the vehicle, an audio warning/ chime is sounded.

### PESS-WEARABLE KEY (if available)

- You can wear it on wrist and drive the car (ease of carrying and us-age).
- The key fob performs dual functions of passive entry/exit and passive start (similar functions of UID).
- Wearable device will work with PEPS vehicle only and it is an add-on device along with the smart key



UID (Smart Key)

Wearable Key

### Peeps Features

#### Passive Entry

#### Entry in vehicle through driver door



Press driver door handle button along with valid wearable key fob within the authentication range of 1.2 m.

#### Tailgate opening of vehicle

Press tailgate handle button along with valid wearable key fob within the authentication range of 1.2 m.

## STARTING AND DRIVING



*Tailgate switch*

### Passive Exit

#### Exit from Vehicle through Driver Door

- Stop the car and turn off the ignition.
- Come out of the vehicle and close the door.
- Press the driver door handle button along with valid wearable key fob within the authentication range of 1.2 m.
- Vehicle get locked.

### Engine Passive Start - Conditions



#### Single Press Start:

1. Bring the smart key with you and sit in the driver seat.
2. Press the clutch pedal and then press the start/stop switch.
3. Green colour LED on start/stop button will turn ON.
4. Once engine is started successfully, the green colour LED on start/stop button stays ON.

#### Two Step Start

##### a) Step 1

1. Have the smart key with you and sit on the driver's seat.
2. Press the start/stop button without pressing clutch pedal.
3. Amber colour LED on start/stop switch turns ON.
4. Engine will remain OFF and all electrical equipment and infotainment system can be used. Steering is un-locked.

##### b) Step 2

1. Press the clutch pedal and then press start/stop button to start the engine.
2. Green colour LED on start/stop button will turn ON.
3. Once engine start successfully, green colour LED on start/stop switch will remain ON.

#### Three Step Start

##### a) Step 1

1. Have the smart key with you and sit on the driver's seat.
2. Press the start/stop button without pressing clutch pedal.

3. Amber colour LED on start/stop button will turn ON.
4. Limited information will be displayed on instrument cluster and steering will be unlocked. Engine remains OFF.

### b) Step 2

1. Press the start/stop button without pressing clutch pedal again.
2. Green colour LED on start/stop button will turn ON.
3. Engine will remain OFF but all electrical equipment and infotainment system can be used.

### c) Step 3

1. Press the clutch pedal and then press start/stop button to start the engine.
2. Green colour LED on start/stop button will turn ON.
3. Once the engine is started successfully, the green colour LED on start/stop button stays ON.

### Backup Start

- If wearable key fob's battery is low or drained, kindly refer the battery re-

placement procedure of key fob in maintenance section. Customer should always carry the key fob along with wearable key.

- In this condition, customer has to keep the key fob in center console antenna (refer below image).



- To start the engine when the wearable key fob's battery voltage is low or empty, user needs to press start/stop button two times with interval of 2.5 seconds along with the clutch. Engine will get cranked.

### Engine Passive Stop - Conditions

#### Single Press Stop

- IGN is ON and engine is running.
- Press the start/stop button with or with-

out clutch.

- ACC and IGN turns OFF.
- LED on start/stop switch turns OFF.

#### Single Long Press Stop

- IGN is ON and engine is running.
- Vehicle is in running condition i.e. wheel rpm >10 RPM or wheel sensor faulty.
- Press the start/stop button for more than three seconds.
- IGN returns OFF, ACC remains ON.
- Amber colour LED on start/stop switch turns ON.

### WARNING

When vehicle is in OFF mode (ACC, IGN and Crank OFF) and user tries to lock the vehicle from outside by pressing any door handle switch and if PEPS detects that the smart key is left inside the vehicle, an audio warning/ chime is sounded.

## STARTING AND DRIVING

### GEAR SHIFTING



The gearshift pattern is as shown on the gear lever knob. Gear shifting should always be done with the clutch pedal fully pressed.

#### **i** NOTE

- Gear recommendation is displayed when the clutch pedal is fully released.
- If "F" is displayed in DIS of instrument cluster, it means 'Fault' condition. Contact TATA MOTORS

*Authorized Dealer/Service Center.*

- Press the clutch fully when gear shifting. The reverse gear should be engaged only when the vehicle is stationary.
- Use the clutch only to shift gears and do not use it when vehicle is stationary on a slope, as the car will roll down due to gravity.
- If all doors are closed when the vehicle is in ACC/IGN/RUN mode and if PEPS does not detect the smart key inside the car, then an audio warning is given.
- Do not rest your hand on the shift lever during driving; Pressure transmitted from your hand may result in premature wear of the transaxle internal gear shift mechanism.

### REVERSE GEAR

To engage reverse gear, shift to re-verse position as shown on the gear lever knob.



### DRIVING

#### Climbing Sharp Gradients on Loose Surfaces

Start off smoothly in a suitable gear. Accelerate smoothly so that there is no loss of traction by over-revving of the engine.

Choose a smooth slope and select the appropriate gear so that gear changing in the middle of the climb is not required.

Changing gears in the middle of the climb can cause loss of momentum and engine stalling. Shifting to lower gear has to be done cautiously to avoid loss of traction.

Under no conditions should the vehicle be moved diagonally across a hill. The danger is in loss of traction and side-ways slippage, possibly resulting in toppling over. If unavoidable, choose a mild angle and keep the vehicle moving.

If the tyres start to slip within few feet at the end of the climb, keep the vehicle stable by steering left and right. It gives increased grip to the tyres.

If the vehicle stalls or losses headway while climbing a steep hill, make a quick

shift to reverse and allow the vehicle to move back with the help of engine braking.

#### Descending Sharp Gradients

Depending on the severity of the gradient, shift into appropriate gear. Use engine braking judiciously without over-revving the engine.

Brake gently in such situations.

#### WARNING

When descending on sharp gradients, do not turn the ignition key to the 'OFF' position. The braking assist and steering assist may malfunction and the emission control system may be damaged.

### STARTING the ENGINE

Make sure that parking brake is engaged and vehicle is in neutral gear.

Press the clutch pedal fully and crank the engine. Do not press the accelerator pedal when starting the engine.

Release the key as soon as the engine starts. Repeat if engine does not start.

#### WARNING

The engine emits poisonous exhaust gases such as carbon monoxide. Inhaling these exhaust gases leads to poisoning. There is a risk of serious health problems. Therefore, never leave the engine running in enclosed spaces without sufficient ventilation.

#### NOTE

*The engine emits poisonous exhaust gases such as carbon monoxide. Inhaling these exhaust gases leads to poisoning. There is a risk of serious health problems. Therefore, never leave the engine running in enclosed spaces*

## STARTING AND DRIVING

*without sufficient ventilation.*

### BRAKING

Your vehicle has vacuum assisted brakes.

The distance needed to bring the vehicle to a halt increases with the speed of the vehicle. Start applying brake anticipating the distance and slow down gradually.

#### **WARNING**

- Do not use the brake pedal as a footrest.
- If you rest your foot on the brake pedal while driving, the braking system can overheat and cause fading of brake pads. This increases the stopping distance and can even cause the braking system to fail. There is a risk of an accident.
- Do not press the brake pedal and the accelerator pedal at the same time.

If you have driven for a long time in heavy rain without braking, there may be a delayed reaction from the brakes when you brake for the first time. This may also occur after the vehicle has been washed.

Brake performance may become poor and unpredictable if brakes are wet.

After you drive through water or if you wash the underside of the vehicle, test the brakes at slow speeds to see if the brakes work fine. If the brakes are less effective than normal, dry them by repeatedly applying the brakes at slow speeds until the brakes have regained their normal effectiveness.

Check traffic conditions before doing the above activity.

### Braking on Downhill Gradients

When you drive on downhill slopes, reduce the load on the brakes by shifting to a lower gear. This is called as engine braking and aids to reduce overheating and wear of brakes.



### WARNING

- Do not shift to lower gears on a slippery road surface to increase the engine's braking effect. By doing so, the tyres could lose their grip.
- There is an increased danger of skidding and accidents.

### DRIVE MODE (as available)



*Drive mode selection switch*

These modes can be used to adjust engine characteristics and vehicle performance in line with desired requirement.

Drive mode selection switch is provided on center console for activation.

According Engine type the car is equipped with 'City' (Default) and 'Eco'.

City is being default mode in each ignition cycle.

Variant wise applicable drive modes are as below:

Engine	Mode 1 (default)	Mode 2
Diesel	City	ECO
Petrol (NG NA)	City	ECO
Petrol (NG TC)	City	Sport

Drive Mode	Performance
CITY	Increased engine Torque and Power output for BALANCED performance
ECO	Optimum engine Torque and Power output for FUEL EFFICIENT performance
SPORT	Driver can use maximum torque from engine.

## STARTING AND DRIVING

### CENTER LOCK UNLOCK (as available)



All the doors can be lock and unlock from inside the vehicle by pressing this switch.



#### ***i*** NOTE

*Ensure that all doors are closed while using the center locking switch.*

### CURRENT GEAR INDICATION

The Driver Information display (DIS) in the Instrument Cluster indicates the current gear position engaged. **2** or **3**

### GEAR RECOMMENDATION

Up or down arrow will be displayed in DIS, recommending whenever gear should be shifted to up or down



### IDLE STOP START (ISS) (if available)



Idle Stop Start system is a Green Environment initiative.

Your vehicle is equipped with fuel saving ISS feature to shut off the engine to conserve fuel and emit less carbon dioxide.

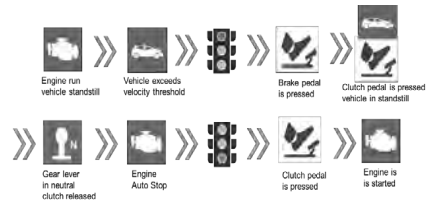

*ISS function*

### Working

Starting the vehicle initially will be by conventional method (key start or push button start). When the vehicle is stationary and engine is idle (in a traffic light, traffic jam, toll gate, etc.) it will turn-off automatically. When the clutch pedal is pressed, the engine will restart automatically. Engine may also restart automatically without Clutch pedal press due to other preconditions which are captured below.

### Sequence Of Function

1. Vehicle started through Ignition key or Push button switch.
2. Vehicle is in standstill and Engine is running.
3. Vehicle moves forward and exceeds speed threshold values.
4. When vehicle is to be stopped (scenario: Red signal), press the brake and then, press the clutch. The vehicle comes to a halt. Shift the gear to neutral and release the clutch. Engine will be automatically stopped.
5. When you want to move (Scenario:

Green signal), Press Clutch pedal to start.

6. Engine will automatically start when Clutch is pressed fully.

This system enables the ISS functions automatically when Ignition is turned ON. If you do not want to use this feature, you can switch it off by pressing the ISS OFF switch provided in the vehicle.



### Following Conditions Will Prevent ISS Function Standby not Enabled

- Engine hood (bonnet) is open
- Reverse Gear is engaged.
- Outside temperature is too low or too high
- Battery system is unhealthy.
- Engine coolant temperature is too low
- Driver presence is not detected (Seat

## STARTING AND DRIVING

belt is not fastened)

- Driver door is open
- Any system fault

Warning light will be displayed on the instrument cluster to indicate the healthy status of this function.

### Special Feature of Automatic Restart

This system is equipped with a special feature of Automatic Restart. Under certain conditions, the Engine will automatically restart on its own in order to meet your Safety and Comfort requirements.

This can occur especially when the vehicle is standstill and following conditions occurred,

- Battery is being discharged too low.
- Vehicle started rolling forwards/ backwards
- Brake has been pressed repeatedly for several times/brake Pressure too low
- When the Cabin temperature is too hot/too cold
- Defrost button is pressed

### NOTE

- *Your vehicle is equipped with ISS function which may automatically Stop and Restart the engine. Do not panic and follow the messages on the display to understand the event.*
- *Use an alternator that has been approved by Tata Motors. Otherwise your ISS function may not work. Contact nearest Tata Motors authorized dealer for alternator replacement.*
- *ISS will be available only when driver's seat belt is fastened at all times.*
- *Use a battery that has been approved by Tata Motors. Otherwise your ISS function may not work as intended. Contact nearest Tata Motors authorised dealer for battery replacement or any issues in battery.*
- *ISS function may not be active when the Safety (Example: Seat Belt) and Comfort (Example: AC in high demand) conditions are not*

*met. Do not panic and follow the messages on the display to understand the event.*

- *Do not remove the Battery Sensor from Battery. Removal of Battery sensor will result loss of function. Function will be automatically restored when the vehicle is parked for a period of three hours.*
- *In the event of traffic, ISS function may work with delay in auto-stop which is intended logic.*
- *Use a battery sensor that has been approved by Tata Motors. Otherwise your ISS function may not work as intended. Contact nearest Tata Motors authorized dealer for battery sensor replacement.*
- *Engine will be automatically started again when the following safety conditions are met: driver presence, gear in neutral, bonnet and doors should be closed. In case if any of these criteria are not met, a message will pop-up on the screen to in*

*dicating the user to start the car manually.*

- *To fill up fuel, the engine must be stopped by turning OFF the ignition key / ISS button.*
- *Switch the engine off before you perform any operation in the engine compartment.*

### Frequently Asked Questions

#### 1. What are the advantages of this feature?

This feature helps to reduce the fuel consumption, CO2 emission by automatically shutting down the Engine when the Vehicle is in standstill conditions like traffic signal, Traffic jam, etc.

#### 2. When the Vehicle is in Engine Idle stop start Phase, how can I start the Vehicle to move?

Simply press the Clutch fully down to Start the Vehicle. No need to use Key / Push Start Switch.

#### 3. Can I start the Engine only by pressing the Clutch Pedal for the first

#### time when I enter in Vehicle?

No. Always the first start has to be through Ignition Key or Push button.

#### 4. How can I activate / deactivate this feature?

This feature will be active as default when Ignition is ON. If you wish to switch it OFF, press the ISS switch.

#### 5. Whether AC will work when the Engine is in Idle stop start mode?

No. AC function will not be available when the Engine is in Idle stop start mode. Only Blower will be functional.

#### 6. How to start the Engine if feeling too hot / too cold when Engine is in Idle stop start mode?

In the event of higher temperature difference, Engine will automatically restart without any user input. As an alternate user can start the Vehicle by pressing the Clutch pedal fully.

#### 7. What will happen if I press the Clutch continuously in traffic signals?

System will not shut down the Engine automatically when the Clutch is pressed continuously.

#### 8. Whether I am allowed to crank the Vehicle normally when the system is in Idle stop start mode?

Yes. You can perform the normal cranking by switching off and Switch ON the Ignition Key / Push button.

#### 9. Whether the vehicle will stop and restart when the Vehicle is in Gear condition?

No. Idle Stop and Start function will not work when the Gear level is not in Neutral.

## STARTING AND DRIVING

### Smart Alternator Management

Smart Alternator management (applicable if equipped with Intelligent Alternator Control feature) – a Green Environment initiative.

Your vehicle is equipped with fuel saving smart alternator management system to recuperate the brake energy to charge the Battery to help conserve fuel, CO2.

#### Working

When the Vehicle is running, if the acceleration demand is higher than threshold, smart alternator management system will allow the Battery discharge to reduce the load on the Engine.

When the Vehicle is in deceleration and the accelerator demand is lower than threshold, smart alternator management system recuperates the brake energy and charges the Battery.

Battery discharge and charge behavior is dynamic behavior during the Vehicle running.

### Following Conditions Will Prevent Smart Alternator Function Standby/not Enabled

- Head Lamp ON (Low / High)
- Battery System is unhealthy
- Any System fault.

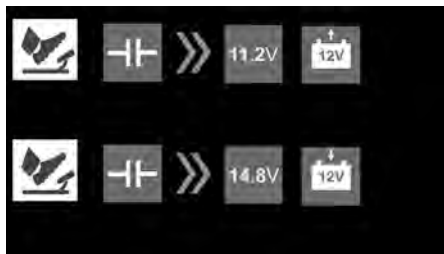

*Alternator function*

### Frequently Asked Questions

#### 1. What are the advantages of this feature?

This feature helps to reduce the fuel consumption, CO2 emission by balancing the Battery discharge and charge during the Vehicle running.

#### 2. Do I need to adjust my driving pattern to enable this function?

No. This smart function will automatically perform this smart alternator function and adjust to your driving pattern.

#### 3. Is there any issue to my Battery charging due to this function when I follow aggressive driving cycle?

No. This smart function is capable enough to manage the Battery charging according to your drive cycle.

#### 4. Do I see any variation in my head lamp performance when the Battery charge / discharge behavior which is dynamic?

No. This smart function will accommodate the charge / discharge behavior according to the head lamp status.

**5. Do I see any perceivable variation in my system function when this function executed?**

No. This smart function won't create any functional issue to the vehicle system. You may see some difference in air flow of blower when it is in higher speed when this function is active. But this won't affect the quality of the vehicle function.

### PARKING BRAKE

Mechanical parking brake acting on the rear wheels is provided on the vehicle.



*Parking brake applied*

To apply the parking brake, pull the lever up fully. The parking brake tell-tale light comes on in the instrument cluster.



*Parking brake released*

To release it, pull the lever up slightly, press the release button and push the lever down. The parking brake tell-tale in the instrument cluster will turn 'OFF' when the lever is fully released.

#### **NOTE**

*Apply the parking brake properly before leaving the vehicle and release it before moving.*

## STARTING AND DRIVING

### VEHICLE PARKING

- Park the vehicle in a safe place. Switch on the indicator signal before turning to park.
- Apply the parking brake.
- Make sure that all window glasses are closed and all lamps are turned 'OFF'.
- At night, put on the parking lights if required.
- Remove the key from the ignition switch and lock the vehicle.
- Use wheel chocks if the vehicle is parked on a slope.

#### **i** NOTE

*When parking on a downhill gradient, place the gear lever in 'Reverse' position. While parking on uphill gradient, place the gear lever in the '1st' position.*

#### **⚠** WARNING

Never leave children unsupervised in the parked vehicle. They could also operate the vehicle's equipment. There is

a risk of an accident and injury.

#### **i** NOTE

*Do not use parking brake for braking unless unavoidable circumstances like when service brake is not working properly. The braking distance is considerably longer and the wheels could lock. There is an increased danger of skidding and accidents.*

### REVERSE PARK ASSIST WITH SENSOR (if available)

Reverse Park Assist system is an electronic parking aid that will assist you to park your vehicle safely when in re-verse gear mode. It provides audio and visual information through the vehicles infotainment system.

Always look out for kids, pets and elderly people behind the vehicle before reversing.



There are ultrasonic sensors placed in on the rear bumper. Number of sensors may vary depending on the variant.

Once the system is activated, the sensors will detect how near the obstacle is from the bumper, and this information is would



be displayed on the vehicle's infotainment system. In base variants, only audio warning shall be given through a buzzer.

When the Reverse Park Assist system activated, an audio will be heard for the first two seconds to indicate that the system is working fine. After that, system will resume its usual function. If no audio warning is heard for first two seconds, it means that RPAS system is faulty. Please take the vehicle to your nearest TATA MOTORS authorized service center.

### **WARNING**

Due to ultrasonic sensor technology limitation, detection of obstacles from 0-25 cm is not guaranteed.

Approximate Distance From Bumper (in Cm)	Tone Information
25-40	Continuous Beep
41-80	Fast Beep
81-120	Slow Beep

Variant where infotainment display is not present and audio warning is given through a buzzer, on activating the Reverse Park Assist system, a tone will be played within first two seconds to indicate the proper functioning of the system. After these two seconds, normal functioning of the system will continue. If no tone is heard for first two seconds, it shall mean that RPAS system is faulty. The owner should, in that case, go to the nearest dealer for rectification.

### **Park Assist Indications**

In case reverse park assist system malfunctions, the following message may appear on the infotainment screen.

Reason for this fault may be

- Park Assist Controller / Body Control Module Failure”
- Sensor Malfunction
- Partner components such as Infotainment music system, Instrument Cluster failure.

 **CRITICAL FAULT** 28.5°C 

Park Assist system not available  
get it rectified by TATA Dealer

## STARTING AND DRIVING

### Reverse Park Assist Limitations

Reverse Park Assist system is not a collision avoiding system. It is solely the driver's responsibility to park the vehicle safely.

Reverse Park Assist feature works on ultra sound echo technology, due to which performance is not guaranteed in following scenarios:

- If the object has a sharp edge surface, where surface may divert echoes from sensor reception.
- If object is mesh fence made up of thin wires, where echoes can't be given by the surface.
- Fast moving objects passes in the sensor's field of detection, where echoes are not processed by the system.
- If object is made/covered by foam or sponge or snow where ultrasonic sound signals are absorbed.
- Objects close to the rear bumper can go undetected by the Reverse Park Assist's field of detection. Driver should use extreme caution while

parking the vehicle.

- If height of the bumper is changed due to alteration to the suspension or other causes
- If the sensor areas are extremely hot from direct sunlight or cold due to freezing weather.
- If Sensors are covered by a hand, sticker, accessory, etc.
- If ultrasonic noise is present around Vehicle due to other vehicle sensors, horn, engine, air braking system (large vehicles), Exhaust Fans, Wireless transmitters or mobile phones
- If the vehicle speed exceeds 10kmph, the system will not warn you even though objects are detected, error message 'Vehicle Speed is high, drive slowly!' will appear.
- Driving on uneven road surfaces e.g. Gravel, unpaved roads, Artificial Speed Breakers, or gradient.

### WARNING

Due to any reason, if the sensor gets misaligned or loses its intended fitment position, contact your dealer for refitment.

### NOTE

*Turning the ignition 'OFF' while the park assist feature is active would disable it.*

### Reverse Park Assist System Preventive Maintenance

- Regularly clean the sensors and keep them free from dust, ice, mud, water, chewing gum etc. for proper working of the system. Use a smooth cloth for cleaning.
- Do not use water at high pressure for cleaning the sensor or camera.
- Do not cover the sensors surface with any additional fitment. This will interrupt park assist performance.

### REAR VIEW CAMERA (if available)



Rear View Camera is a visual reverse guiding system. When reversing or parking, make sure that there are no persons, animals or objects in the area where you are reversing.



*Display screen*

#### **Activation**

This system will start, if reverse gear is engaged, or park assist button (if available) is pressed or manual activation is done through Infotainment screen.

#### **Deactivation**

System will stop, if reverse gear is disengaged, or park assist button (if available) is pressed.

If started through infotainment, the system can be stopped using a cross button on infotainment screen.

### Understanding Guidelines Indication



#### **Green Line**

You can safely reverse the vehicle, but be cautious if objects fall in this zone.

#### **Yellow Line**

You have to take utmost care if objects fall in this zone. However, the objects may not hit vehicle.

#### **Red Line**

Red line indicates that you have to stop reversing the vehicle. If you still go backwards, the car will hit the obstacle.

## STARTING AND DRIVING

### Do's and Don't

- Do not use camera when tailgate is open. If tailgate is open, visual information may not be the actual rear view of the vehicle & system will warn with message 'Tail Gate Open, Please close.
- When the camera is operated under fluorescent lights, sodium light or mercury light etc., illuminated areas on the lens may appear to flicker in the display.
- Do not attach any advertisement or styling or any kind of stickers on top of camera. If this happens, camera cannot provide you the visual image and it may damage the camera.
- Do not add any accessory, which will cause blockage to the camera's field of view.

### Cleaning Camera

1. Due to environmental reasons like snow, dust, mud or fog may accumulate on the camera lens. So regularly clean the camera lens.
2. Use water to clean the camera lens. Do not use extreme cold or hot water. Rapid changes in temperature may brittle the camera lens. Do not apply High Pressure water for cleaning.
3. Wipe the camera lens with soft cloth.
4. Do not use hard cloth or material to wipe the camera lens. This will cause scratches on the camera, and leads to deteriorated visual image on the display.
5. Do not apply organic solvent, car wax, window cleaner or glass coat to clean the camera. If this is applied, wipe it off as soon as possible.
6. Do not apply heavy force on lens, while cleaning.
7. Do not remove mud, snow on the camera lens using stick or hard material. Use normal water and soft cloth.

### WARNING

- The camera uses fish eye lens. So the size of the objects or in the display may differ from the actual size and distance. In low light conditions, the screen may darken or image may appear faint.
- If the tire sizes are changed, the position of the fixed guidelines displayed on the screen may change.
- During rainy conditions, image may get obscured. In such conditions, do not depend on camera view. The camera used in the vehicle, may not reproduce the same color of the real object.
- In case of damage of the rear portion of the vehicle, camera position may change. Which causes wrong visual information on display. In case of damage, make sure that, camera is fitted properly at the intended location.
- In case of uneven road conditions or up-hill or downhill conditions, do not

depend on rear view camera park aid.

- Do not apply any kind of force on the camera.
- Always use rear View mirrors along with Rear View Camera for confirming the safety of the rear and the surrounding conditions.
- High humidity and variation in ambient temperature may result into condensation inside the camera lens, which may further result into degradation of camera video feed on the screen. It is recommended that not to rely on camera video feed for parking assistance in such scenario. This phenomenon is temporary and will be automatically recovered with reduction in humidity and less variation in ambient temperature.
- The area displayed by the rear view camera is limited. The camera does not display objects that are close to or below the bumper, underneath the vehicle, or objects out of the

camera's field of view. The area displayed on the screen may vary according to vehicle orientation or road conditions.

### Rear View Camera System Precautions

#### Area Displayed on Screen

The rear view camera system displays an image of the view from the bumper of the rear area of the vehicle.

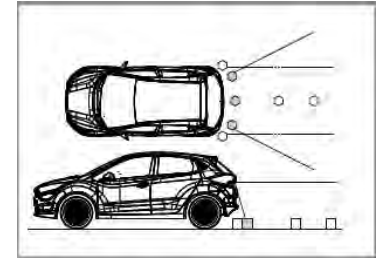

## STARTING AND DRIVING

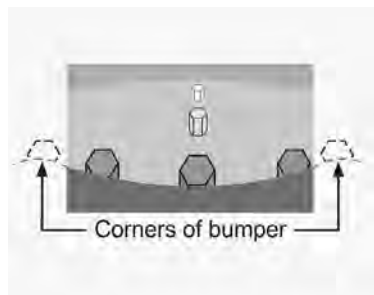

The area displayed on the screen may vary according to vehicle orientation conditions.

Objects, which are close to either corner of the bumper or under the bumper, cannot be seen on the screen.

The camera uses a special lens. The distance of the image that appears on the screen differs from the actual distance. The camera may not display items that are located higher than the camera's field of view.

**When Sharp Up Gradient Behind the Vehicle**

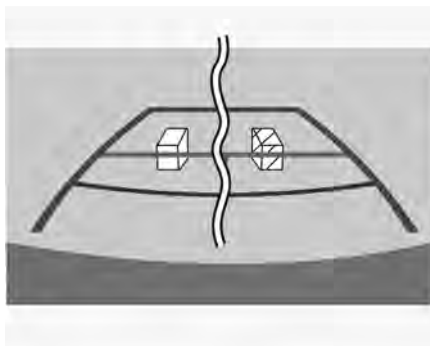
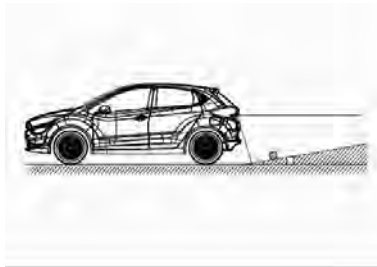

**When Sharp Down Gradient Behind the Vehicle**

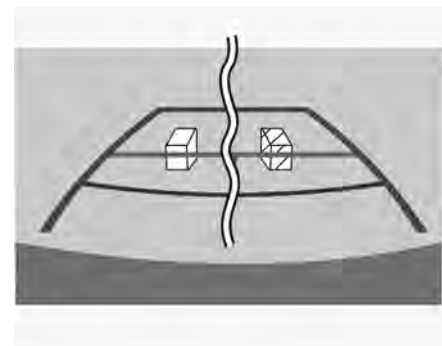
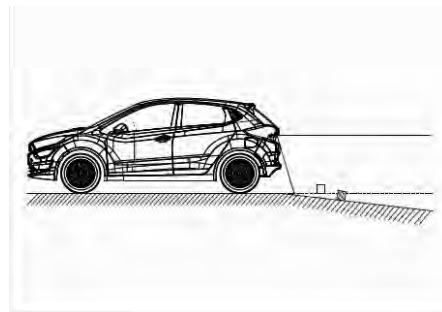

### **i** NOTE

*The distance guidelines will appear to be further from the vehicle than the actual distance.*

*Because of this, objects will appear to be closer than they actually are. In the same way, there will be a margin of error between the guidelines and the actual distance/course on the road.*

### When Any Part of the Vehicle Sags

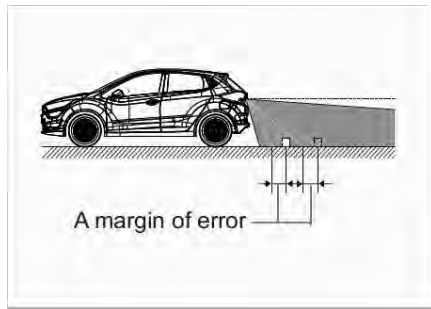

When any part of the vehicle sags due to the number of passengers or the distribution of the load, there is a margin of error

between the fixed guide lines on the screen and the actual distance/course on the road.

### When Approaching Three-dimensional Objects

The distance guidelines are displayed according to flat surfaced objects (such as the road). It is not possible to determine the position of three-dimensional objects (such as vehicles) using the distance guidelines. When approaching a three-dimensional object.

#### a. Distance guideline

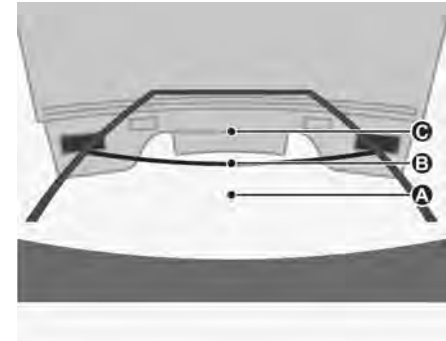
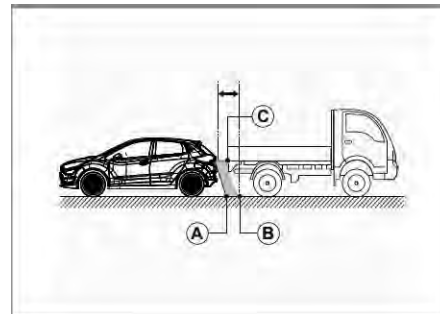

Visually check the surroundings and the area behind the vehicle. On the screen, it appears that a truck is parked at point B. However, in reality if you back up to point A, you will hit the truck. On the screen, it appears that A is closest and C is furthest away. However, in reality, the distance to A and C is the same, and B is further away from A and C.

## STARTING AND DRIVING

---

### b. Vehicle width guidelines



actually cross over the vehicle width guidelines. In reality if you back up as guided by the vehicle width guidelines, the vehicle may hit the truck.

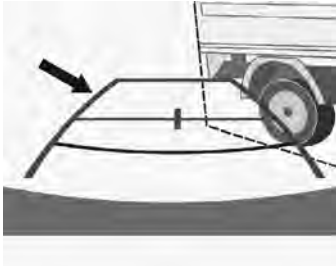

Visually check the surroundings and the area behind the vehicle. In the case shown below, the truck appears to be outside of the vehicle width guidelines and the vehicle does not look as if it hits the truck. However, the rear body of the truck may



### EMERGENCY EQUIPMENT

You should be familiar with the location of the emergency equipment provided in the vehicle and how to use it.

Do a check of this equipment periodically and make sure that they are in proper working condition and stowed at their locations.

#### First Aid Kit

The first aid kit is kept inside the glove box compartment.

The kit contains items that can be used in case of minor injuries only.

#### **i** NOTE

*Examine contents of the first aid kit periodically and replenish consumed or expired items.*

#### Tool Kit, Tow Hook, Jack and Spare Wheel

Tool kit and Jack are accommodated in Tool bag located in the rear boot.



- Jack handle
- Tow hook
- Wheel spanner
- Jack

#### **i** NOTE

*The jack should be used only to change wheels. It is important to read the instructions in this section before attempting to use the jack.*

#### Advance Warning Triangle

An advance warning triangle is kept in the luggage compartment beside the spare wheel.



Use advance warning triangle to warn the approaching traffic in case of vehicle break-down or during emergency, where your vehicle could become a potential traffic hazard.

Keep the warning triangle at an approximate distance of 50-150 m behind your vehicle in the same lane of traffic. The reflecting side of the triangle should face the oncoming traffic and it should be free from

## EMERGENCY AND BREAKDOWN ASSISTANCE

any obstacles.

Remove the advance warning triangle carefully from the bag and assemble. Refer instructions given on the bag.

### **i** NOTE

*After using the warning triangle tie it firmly and keep it inside the bag to avoid rattling noise.*

### Hazard Warning Switch

Press the hazard warning switch to activate the hazard warning. All the turn signal lamps will flash simultaneously. To turn OFF, press the switch again.



Use the hazard warning to warn the traffic during emergency parking or when your vehicle could otherwise become a traffic hazard.

The hazard warning lamps can operate even if the ignition is switched off.

## SPARE WHEEL REMOVAL PROCESS

- To access the spare wheel, lift the carpet up.

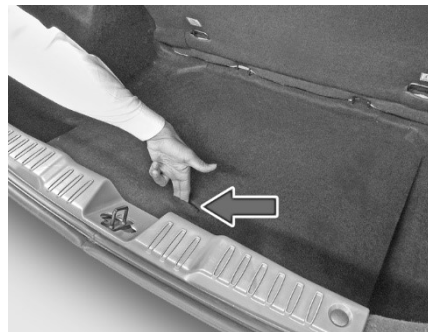

- After lifting, hold the carpet to access the spare wheel.
- Take out the advance warning triangle kept beside the spare wheel.
- Take out the Tool kit bag along with contents.

## EMERGENCY AND BREAKDOWN ASSISTANCE



- To remove the spare wheel, unscrew and remove the retaining bolt.



### IN CASE OF FLAT TYRE

- Reduce vehicle speed gradually, Avoid sudden steering movement or braking.
- Pay attention to the traffic conditions as you do so.
- Switch on the hazard warning lamps.
- If possible, bring the front wheels into the straight-ahead position.
- Stop the vehicle on solid, non-slippery and level ground, as far away as possible from traffic.
- Set the parking brake firmly and shift into "R" (Reverse) gear.
- Switch off the engine.
- Secure the vehicle against rolling away.
- Keep advance warning triangle at a suitable distance behind the vehicle as an indication of breakdown.
- Close all the doors.
- Use the Jack on level, hard ground. Avoid changing the wheel on uphill and downhill slopes. Chock the wheels, if the deflated wheel needs to be

## EMERGENCY AND BREAKDOWN ASSISTANCE

changed on slope / ghat area.

### **WARNING**

If you drive with a flat tyre, there is a risk of the following hazards:

- A flat tyre affects the ability to steer or brake the vehicle.
- You could lose control of the vehicle.
- Continued driving with a flat tyre will permanently damage the tyre and cause excessive heat buildup and possibly a fire. There is a risk of an accident.

### **Changing Flat Tyre**

Loosen the nuts (as indicated) on the wheel in diagonal sequence. Do not unscrew the nuts completely before raising the vehicle using the jack.



*Wheel nut removal*

### **NOTE**

- *The jack is designed only to raise and hold the vehicle for a short time while a wheel is being changed. It is not suited for performing maintenance work under the vehicle.*

- *Use the jack on level, hard ground. Avoid changing the wheel on uphill and downhill slopes. Chock the wheels, if the deflated wheel needs to be changed on slope / ghat area.*
- *Before raising the vehicle, secure it from rolling away by applying the parking brake.*
- *Do not use wooden blocks or similar objects as a jack underlay.*
- *Do not place your hands and feet or lie under the raised vehicle when it is supported by a jack.*
- *Do not run the engine when the vehicle is supported by the jack and never allow passengers to remain in the vehicle.*
- *Do not open or close a door or the tailgate when the vehicle is raised.*

### Jack Up Point Location on Vehicle



Jack up point location

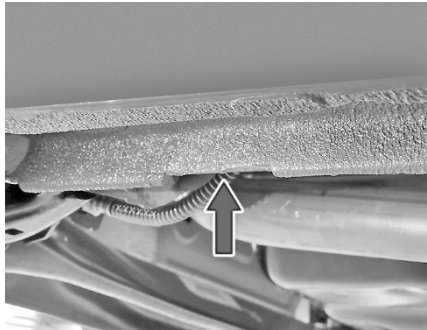

Jacking point location

### WARNING

If you do not position the jack correctly at the appropriate jacking point of the vehicle, the jack could tip over with the vehicle raised. There is a risk of injury. Also jack can be damaged.

Continue to raise the jack slowly and smoothly until the tyre clears the ground. Do not raise the vehicle more than required.



Lifting the front wheel using jack

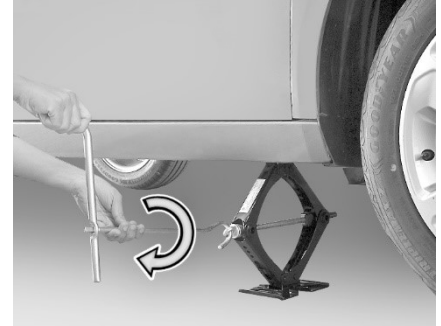

Lifting the rear wheel

Remove wheel nuts with the help of wheel spanner and take out flat tyre.

### NOTE

Do not place wheel nuts in sand or on a dirty surface. Do not apply oil or grease on it.

Roll the spare wheel into position and align the holes in the wheel studs.

Tighten each nut by hand until the wheel is securely seated on the hub.

Lower the jack completely then tighten the wheel nuts one by one using wheel span-

## EMERGENCY AND BREAKDOWN ASSISTANCE

ner.

Press fit the wheel cover back (if fitted).

Restore all the tools and jack at their respective locations.

Place the flat tyre at spare wheel location.

### NOTE

*Do a check and correct the tyre pressure and wheel nuts tightness of the changed wheel at nearest authorised service station. Get the flat tyre repaired at the earliest  
Place the jack only at recommended jacking locations.*

## PUNCTURE REPAIR KIT (if available)

### Introduction

#### WARNING

Compliance with these instructions is vital to ensure vehicle safety. Non-compliance with these instructions means risking tire damage, which can affect vehicle handling and lead to loss of vehicle control. This may result in serious injury or death. Inform all other users of the vehicle if standard items for dealing with a puncture (e.g. spare tire) have been replaced by the Puncture repair Kit.

The Puncture repair Kit seals most tire punctures to restore temporarily mobility. Recommended use only for passenger car ground tires only and vehicle tire inflation pressure up to 300 kPa (3 bar, 43 psi). The system consists of a compressor and a sealant, and serves to effectively and conveniently seal punctures in car tires caused, for example, by nails or similar foreign objects with a diameter of up to ¼

“ (6 mm).

Depending on the type and extent of tire damage, some tires can only be partially sealed or not sealed at all. Loss of tire pressure can affect vehicle handling, leading to loss of vehicle control. Observe the following rules when using the Puncture repair Kit:

- Drive with caution and avoid making sudden steering or driving maneuvers, maneuvers, especially if the vehicle is heavily loaded or you are towing a trailer.
- The system will provide you with an emergency temporary repair, enabling you to continue your journey to the next vehicle or tire dealer, or to drive a maximum distance of 200 km (120 miles).
- Do not exceed a maximum speed of 80 km/h (50 mph).
- Keep the Puncture repair Kit out of the reach of children.
- Once the Puncture repair Kit has been used for a temporary tire repair, the functionality of the TPMS module (if

## EMERGENCY AND BREAKDOWN ASSISTANCE

applicable) shall be checked by an expert and replaced if necessary.

These instructions provide a step-by-step explanation of how to use the Puncture repair Kit to temporarily repair a tire puncture.

Please read the section on “How to proceed in the event of a tire puncture”.

### **WARNING**

Do not use the Puncture repair Kit if the tire has already been damaged as a result of being driven underinflated. Do not try to seal damage other than that located within the visible tread of the tire. Do not try to seal damage to the tire's sidewall.

### Location In Vehicle

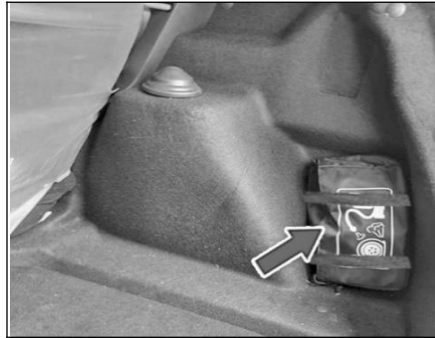

In Luggage compartment

### Puncture Repair Kit Removal Process

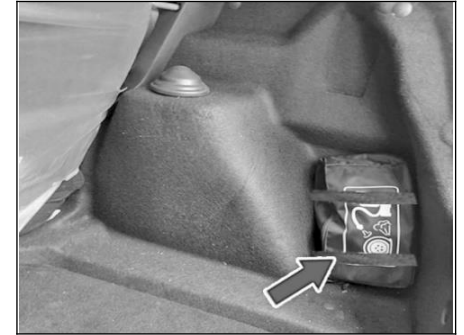

- To access the puncture repair kit open the Tailgate.
- Remove the two Velcro as shown in figure and take out the puncture repair kit.

## EMERGENCY AND BREAKDOWN ASSISTANCE

### Step

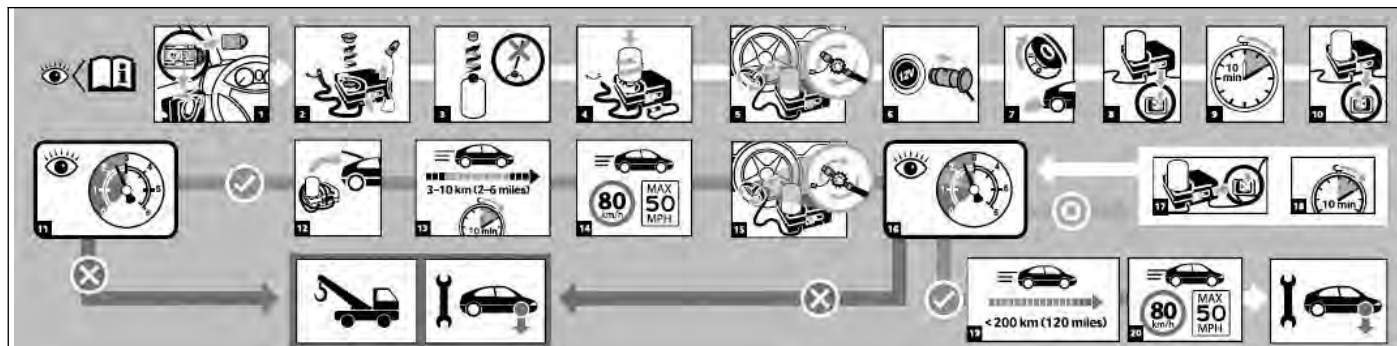



## EMERGENCY AND BREAKDOWN ASSISTANCE

### Instructions On How To Use The Puncture Repair Kit Safely

- Use product with original vehicle ground tires only.
- Only use the Puncture repair Kit with tubeless tires.
- If used for other than its intended purpose, the Puncture repair Kit may cause severe accident or injury due to the fact that compressed air can act as an explosive or propellant.
- Park your vehicle at the roadside so that you do not obstruct the flow of traffic and you are able to use the Puncture repair Kit without being in danger.
- Engage the hand brake, even if you have parked on a level road, to ensure that the vehicle will not move.
- Do not attempt to remove foreign objects like nails or screws penetrating the tire. Leave them as they are.
- Leave the engine running while the Puncture repair Kit is in use, but not if the vehicle is in an enclosed or poorly ventilated area.

- Never leave the Puncture repair Kit unattended while in use.
- Do not keep the compressor operating for more than 10 minutes otherwise there is a risk of it over-heating.
- Replace the sealant bottle with a new one before the expiration date is reached (see bottle label). In case that the sealant is expired the functionality cannot be fully guaranteed. Only use original Puncture re-pair Kit bottles which are pressure resistant.

### How To Proceed In The Event Of Tyre Puncture

You can temporarily repair a tire puncture in two steps.

First pump the tire sealant and air into the tire (see Step 1). Immediately thereafter, drive a short distance (3-10 km / 2-6 miles) in order to distribute the sealant in the tire. After that, check the tire pressure and pump more air into the tire if necessary (see Step 2). Then you can proceed to drive with caution for a maximum distance of 200 km (120 miles) and at a maximum speed of 80 km/h (50 mph).

Inform all other users of the vehicle that the tire has been temporarily sealed with the Puncture repair Kit and make them aware of the special driving conditions to be observed.

### WARNING

Need to drain fluid from tire before repair.

### Step 1 :pumping The Tyre Sealant And Air Into The Tyre

1. Peel off the decal denoting the maximum permissible speed (80 km/h | 50 mph) from the casing and attach it to the edge of the windscreen as shown on the picture.
2. Take the hose and power plug with cable out of the Puncture repair Kit casing. Unscrew the orange cap of the bottle connector.
3. Unscrew the red cap of the sealant bottle. (Shake sealant bottle well before use.

## EMERGENCY AND BREAKDOWN ASSISTANCE

### WARNING

Leave the bottle seal intact. Screwing the bottle onto the bottle holder will pierce the seal of the bottle. Avoid skin contact with the sealant which contains natural rubber latex. Do not open pressure “air release” valve. Please use protective glove for safety purpose.

4. Screw the bottle clockwise firmly against the slight resistance of the notches onto the sealing gasket of the bottle connector until it is screwed tight.
5. Remove the valve cap from the damaged tire. Pull the protective cap off the end of the hose and screw the hose firmly onto the valve of the damaged tire. Make sure that the compressor switch is switched to “0” and the pressure “air release” valve is closed.
6. Insert power plug into the 12 volt power socket connection.
7. Start the engine (only if the vehicle is outdoors or in a well ventilated area).

### WARNING

Asphyxiation may occur if the engine is allowed to run in a non-ventilated or poorly ventilated area (e.g. inside a building)

8. Press compressor switch to “I”.

### NOTE

*Check the sidewall of the tire prior to inflation. If there are any cracks, bumps or similar damage, do not attempt to inflate the tire. Do not stand directly beside the tire while the compressor is pumping. Watch the sidewall of the tire. If any cracks, bumps or similar damage appear, turn off the compressor and let the air out by means of the pressure “air release” valve. In this case, do not continue to use the tire.*

### NOTE

*When pumping in the sealant through the tire valve, the pressure may rise up to 500 kPa (5 bar, 73 psi) but will drop again after about 30 seconds.*

9. Inflate the tire within about 10 minutes to an inflation pressure of minimum 180 kPa, (1.8 bar, and 26 psi) and a maximum of 300 kPa (3 bar, 43 psi).
10. Switch off the compressor briefly in order to read the actual tire pressure from the pressure gauge.

### WARNING

If heavy vibrations, unsteady steering behavior or noises should occur while driving, reduce your speed and drive with caution to a place where it is safe for you to stop the vehicle. Recheck the tire and its pressure. If the tire pressure is less than 130 kPa (1.3 bar, 19 psi) or if there are any visible cracks, bumps or similar damage on the side wall, do not continue to use the tire!

**11, 12.** Once a tire inflation pressure of at least 180 kPa (1.8 bar, 26 psi) has been reached.

- Switch the compressor to “0”.
- Pull the power plug from the 12 volt power socket connection.
- Slowly unscrew the hose from the tire valve (sealant residues may escape from the hose) and put the protective cap back onto the hose.
- Leave the bottle in the holder. This avoids unexpected leakage of sealant residue.
- Make sure the Puncture repair Kit, the cap of the bottle and the orange cap are stored safely, but are still easily accessible, in the vehicle.

The kit will be needed again when you check the tire pressure.

**13, 14.** Immediately start and drive for about 3-10 km (2-6 miles) so that the sealant can seal the damaged area. Do not drive for more than 10 min and not any faster than 80 km/h (50 mph) (observe the decal indicating the permissible speed).

### WARNING

If heavy vibrations, unsteady steering behavior or noises should occur while driving, reduce your speed and drive with caution to a place where it is safe for you to stop the vehicle. Recheck the tire and its pressure. If the tire pressure is less than 130 kPa (1.3 bar, 19 psi) or if there are any visible cracks, bumps or similar damage on the side wall, do not continue to use the tire!

### Step 2 Checking The Tyre Pressure

**15.** Stop the vehicle after driving about 3-10 km (2-6 miles). Check and, where necessary, adjust the pressure of the damaged tire. Remove the protective cap from the end of the hose. Screw the hose firmly onto the valve of the damaged tire.

**16.** Read the tire pressure from the pressure gauge.

If the pressure of the sealant-filled tire is 130 kPa (1.3 bar, 19 psi) or more, it must now be adjusted to the pressure specified for your vehicle (Refer sticker on vehicle).

### WARNING

If the tire check shows that the pressure of the sealant-filled tire is less than 130 kPa (1.3 bar, 19 psi) or if there are any visible cracks, bumps or similar tire damage on the side wall, you must not continue to use that tire.

- Make sure that the compressor switch is switched off to “0”.
- Insert the power plug into the 12 volt power socket connection.
- Start the engine (only if the vehicle is outdoors or in a well ventilated area).

### WARNING

Asphyxiation may occur if the engine is allowed to run in a non-ventilated or poorly ventilated area (e.g. inside a building )

**17,18.** Switch the compressor on to “I” and pump the tire up to the specified tire pressure within max. 10 minutes.

## EMERGENCY AND BREAKDOWN ASSISTANCE

### NOTE

*Compressor unit we can use for filling the air & checking the pressure of the normal tyre.*

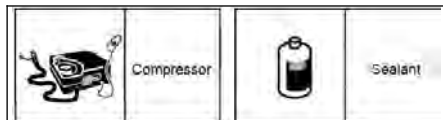

- Switch the compressor off and check the tire pressure again. If tire pressure is too high, deflate the tire to the specified pressure using the pressure “air release” valve.
- Rest of the remaining sealant in the hose might leak out when opening pressure “air release” valve or taking off the protective cap of the hose. Please use protective glove for safety purpose.
- Once you have inflated the tire to its correct tire pressure, switch off the compressor, pull the plug out of the socket, unscrew the hose, fasten the tire valve cap and put back on the pro-

tective cap of the hose.

- Leave the bottle in the holder and store the Puncture repair Kit away safely in the vehicle trunk.

### WARNING

After using the sealant you may drive no faster than 80 km/h (50 mph), and the damaged tire must be replaced as quickly as possible (with in a maximum driving distance of 200 km (120 miles)). You must not continue to drive if heavy vibrations, unsteady steering behavior or noises should occur while driving.

**19, 20.** Drive to the nearest workshop to get the damaged tyre repaired and if the tyre repair is not possible, tyre should be removed from the car. Before the tire is removed from the rim, inform your tire dealer that the tire contains sealant. Sealant deposits in a used hose may impair proper function of the Puncture repair Kit. Both the sealant bottle and the hose need to be replaced together after using the Puncture repair Kit.

### NOTE

*Remember that emergency roadside tire repair kits only provide temporary mobility. Regulation concerning tire repair after usage of Puncture Repair Kit may differ from country to country. You should consult a tire specialist for advice.*

### WARNING

Before driving, ensure tire is adjusted to recommended inflation pressure as indicated on vehicle placard. Monitor tire pressure until sealed tire is replaced. Proceed as described above from point 15 onwards.

New sealant and replacement parts can be purchased from your authorized repair shop or dealer. Sealant bottles can be disposed with house-hold waste.

### JUMP STARTING YOUR CAR

#### For Diesel, Petrol NA & TC Non IAC/ISS Variants

Use only a battery of same rating & capacity to jump start your vehicle. Position the booster battery close to your vehicle so that the jump leads will reach both batteries.

When using a battery of another vehicle, do not let the vehicles touch. Apply the parking brake firmly and keep the gearshift lever in neutral.

Turn off all vehicle accessories, except those necessary for safety like hazard warning lamps.

If your vehicle is equipped with Battery sensor, then do not connect your jump start cable lead directly on the Sensor surface. Connect only on the negative cable surface as shown on the image. After jump start event, IAC function will be restored only when the Vehicle is parked in idle for 3-4 Hours.

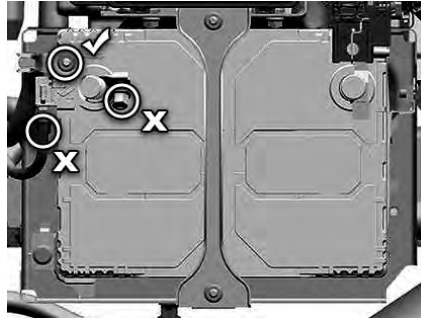

*(For Diesel & Petrol)*

Make jump lead connections as follows:

- Connect one end of the first jump lead to the positive (+) terminal of the discharged battery.
- Connect the other end to the positive (+) terminal of the booster battery.
- Connect one end of the second jump lead to the negative (-) terminal of the booster battery.
- Make the final connection (other end of the negative terminal) to an unpainted, heavy metal part (i.e. engine mounting stud/nut) of the vehicle of discharged battery.

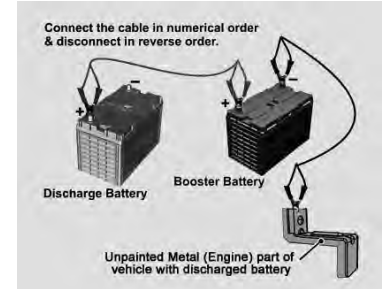

- Start the engine of the vehicle with the discharged battery.
- Before disconnecting the jumper cables, let the engine run for several minutes.
- If the booster battery you are using is fitted to another vehicle, start the engine of the vehicle with the booster battery. Run the engine at moderate speed.
- Remove the jump leads in the exact reverse order in which you connected them.

## EMERGENCY AND BREAKDOWN ASSISTANCE

### **i** NOTE

*Do not disconnect the discharged battery from the vehicle.*

### **⚠** WARNING

- Do not connect the jump lead directly to the negative (–) terminal of the discharged battery. This may lead to an explosion.
- Do not allow battery electrolyte to come in contact with eyes, skin, fabrics or painted surfaces. The fluid contains acid which can cause injury and severe damage. Wear protective apparel. Do not inhale any battery gases. Keep children away from batteries. In case if battery acid comes in contact with the skin, wash it off immediately with water and seek medical attention.
- During charging and jump-starting, explosive gases can escape from the battery. There is a risk of an explosion. Particularly avoid fire, open

flames, creating sparks and smoking. Make sure that there is sufficient ventilation while charging and jump-starting. Do not lean over the battery.

- Make sure that the positive terminal of a connected battery does not come into contact with vehicle parts. Never place metal objects or tools on a battery.
- It is important that you observe the described order of the battery terminals when connecting and disconnecting a battery. If you are in doubt, seek assistance from qualified specialist workshop.
- Do not connect or disconnect the battery terminals while the engine is running.

### **For Petrol NA IAC/ISS Variants**

Following method to be adopted while performing Battery disconnection for any service on Vehicle, Jump Start and external Battery charging.

- Always remove the Battery negative from Battery Sensor output side. Never remove the Battery Sensor directly from Battery. This will result Battery learning loss and this act will switch off the ISS function.
- While performing jump start, ensure that the jump start Battery negative terminal is connected to Battery Sensor output as shown be-low.
- While performing external charging, ensure that charging circuit ground is connected to Battery Sensor out-put as shown below.

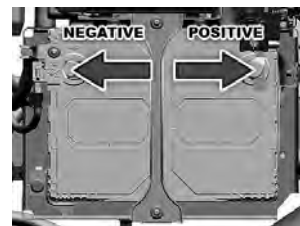

### **Do and Don't** **Do**

- Use only authorized Battery sensor.

- Use only authorized Battery
- Always disconnect the Battery sensor output for any service on vehicle

### Don't

Do not remove the Battery sensor if it is not necessary.

- Do not mallet / hammer the Battery sensor to fix on Battery Pole.
- Do not place the Battery sensor on Positive Pole.
- Do not remove the Battery Sensor connector.

### TOWING



When towing a break down vehicle, certain precautions and procedures must be taken to prevent damage to the vehicle and/or components. Failure to use standard towing precautionary measures when lifting or towing a break down vehicle could result in an unsafe operating condition.

To correctly tow and prevent accidental damage to your vehicle, take help of a TATA MOTORS authorized dealer or a commercial tow-truck service.

### NOTE

*Make sure that the parking brake is released; vehicle is in neutral and steering wheel is unlocked. The power steering functions only when engine is running. Hence, during towing the steering efforts will be more.*

### WARNING

- Do not get under your vehicle after it has been lifted by a tow truck.
- For towing a vehicle, the best way is to use a wrecker. Alternatively use a rigid tow bar.
- Switch 'ON' the hazard warning indicators of both the vehicles to warn other road users.
- Limit the speed to 20-30 kmph.
- In case of brake failure, use the parking brake to control the vehicle.
- Fasten the tow rope or tow bar at the towing eyes. Otherwise, the ve

## EMERGENCY AND BREAKDOWN ASSISTANCE

hicle could be damaged.

- When towing, pull away slowly and smoothly. If the tractive power is too high, the vehicles could be damaged.

### Recommended Towing

In case of break down, we recommend that your vehicle be towed with the driving wheels off the ground or place the vehicle on a flatbed truck as shown.

#### WARNING

- Do not tow your vehicle with the front wheels on the ground or four wheels on the ground (forward or backward), as this may cause serious damage to the transmission.
- When towing with the rear wheels on the ground or on towing dollies, place the ignition switch in the 'ACC' or 'ON' position, and secure the steering wheel in the straight-ahead position with a rope or similar device.

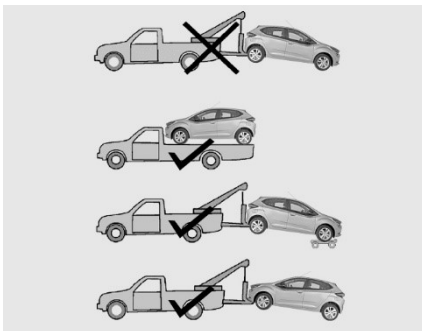

### Tow Hook Fitment

- Open the tailgate and remove tow hook from the tool kit.



- Open the tow hook cover provided on the front bumper by pressing it at the bottom part and simultaneously pulling it at the top (as shown in fig).



## EMERGENCY AND BREAKDOWN ASSISTANCE



- Screw in and tighten the tow hook in clockwise direction.
- After towing, remove the towing hook and press fit the cover properly.
- Place the towing hook in the vehicle tool kit.

### FUSES

Your vehicle has fuse boxes at three locations.

The vehicles electrical circuits have fuses to protect the wiring from short circuits or sustained overload.



1. Battery Mounted Fuse Box.
2. Engine Compartment Fuse Box.
3. Cabin Compartment Fuse Box.

### Checking and Replacing Fuses

If any electrical unit in your vehicle is not functioning, check the fuses first.

Please follow the steps below that will guide you to check and replace them.

- Apply parking brake

- Switch off all electrical accessories.
- Turn the ignition key to the 'LOCK' position.
- In the fuse box, identify the defective fuse from its melted wire.

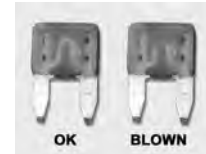

- Remove the defective fuse by "fuse puller". The fuse puller and spare fuses are provided in the engine compartment fuse box.
- Defective fuses must be replaced with fuses of same rating, which you can recognize by color and value.

### **NOTE**

*Always make sure that the spare fuses are added.*

- Make sure that all other fuses are pressed firmly in position.

## EMERGENCY AND BREAKDOWN ASSISTANCE

- If a newly inserted fuse also blows, have the cause traced and rectified at nearest TATA MOTORS Authorized Dealer/Service Center immediately.

### Battery Mounted Fuse Box (diesel)

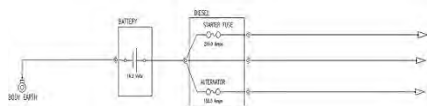

Fuse No	Function	Fuse Rating
PF1	Starter motor	200A

Fuse No	Function	Fuse Rating
PF2	ALTERNATOR	150A

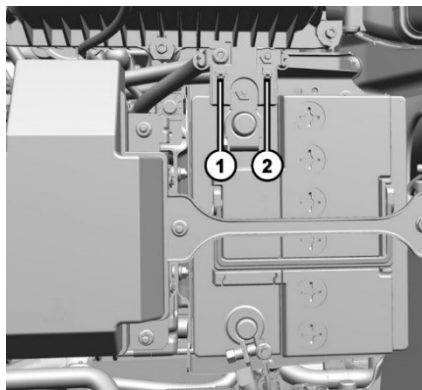

1.PF2 Alternator , 2.PF1 Starter Motor

### WARNING

If fuse box cover is removed for any reason, it should be refitted properly in its original position.

### Battery Mounted Fuse Box (petrol)

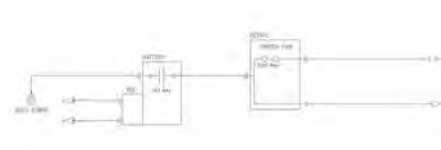

## EMERGENCY AND BREAKDOWN ASSISTANCE

Fuse No	Function	Fuse Rating
PF1	Starter Motor	200A

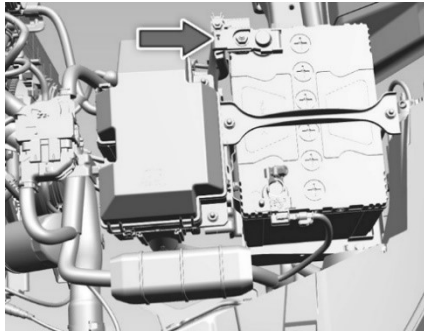

PF1 STARTER MOTOR

### WARNING

If Fuse box cover is removed for any reason, it should be refitted properly in its original position.

### Engine Compartment Fuse Box Fuses-engine Compartment (diesel)

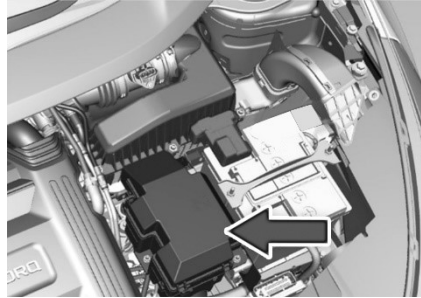

### NOTE

The fuse box layout is for reference purpose only. Please refer the sticker provided inside the fuse box cover.

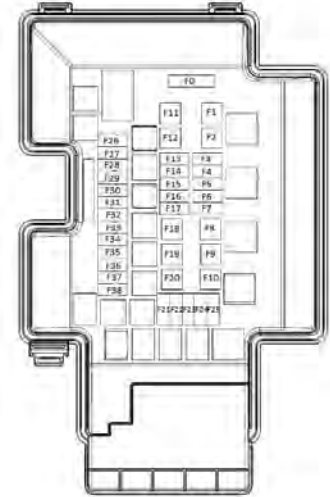

Fuse No	Function	Fuse Rating
F0	-	-
F1	COCKPIT F/B SUPPLY	60A

## EMERGENCY AND BREAKDOWN ASSISTANCE

Fuse No	Function	Fuse Rating
F2	RADIATOR FAN-1	40A
F3	STARTER SOLENOID BATT	25A
F4	-	-
F5	-	-
F6	-	-
F7	-	-
F8	HEAD LAMP/TCU	60A
*F9	GLOW PLUG	60A
F10	EPAS	60A
*F11	RADIATOR FAN-2	40A
F12	UNDER BONNET F/R BOX	60A
F13	EMS BATT	10A
F14	COMPRESSOR	10A

Fuse No	Function	Fuse Rating
F15	ABS ECU BATT	25A
F16	HORN BATT	15A
F17	BRAKE LAMP BATT	10A
F18	ABS PUMP	40A
F19	INTERIOR F/B BATT	60A
F20	IGNITION LOAD	60A
F21	-	-
F22	H/L HIGH RH	10A
F23	H/L HIGH LH	10A
F24	ABS ECU IGNITION	5A
*F25	GLOW PLUG FB	5A
F26	-	-
F27		15A

Fuse No	Function	Fuse Rating
	EMS RELAY COILS & SENSORS	
F28	EMS ECU SUPPLY	20A
F29	-	-
F30	FRONT WIPER MOTOR	20A
*F31	RR WIPER	10A
*F32	STARTER MOTOR FEEDBACK	5A
F33	RELAY COILS*	5A-
F34	-	-
F35	REVERSE LAMPS/BRAKE SWITCH	10A
F36	H/L LOW LH	10A

## EMERGENCY AND BREAKDOWN ASSISTANCE

Fuse No	Function	Fuse Rating
F37	H/L LOW RH	10A
F38	-	-

**Note:**

\* - if equipped

**Fuses-engine Compartment (petrol)**

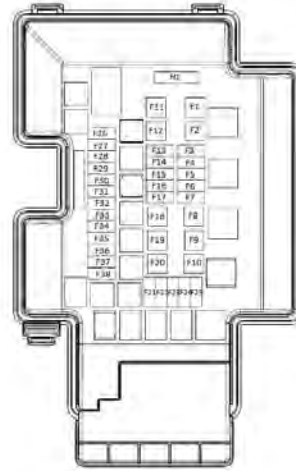

Fuse No	Function	Fuse Rating
F0	-	-
F1	COCKPIT F/B SUPPLY	60A
F2	RADIATOR FAN-1	40A

Fuse No	Function	Fuse Rating
F3	STARTER SOLENOID BATT	25A
F4	-	-
*F5	FUEL PUMP BATT	15A
F6	-	-
F7	-	-
F8	HEAD LAMP	60A
F9	-	-
F10	EPAS	60A
*F11	RADIATOR FAN-2	40A
F12	UNDER BONNET F/R BOX	60A
F13	EMS BATT	10A
F14	COMPRESSOR	10A
F15		25A

## EMERGENCY AND BREAKDOWN ASSISTANCE

Fuse No	Function	Fuse Rating
	ABS ECU BATT	
F16	HORN BATT	15A
F17	BRAKE LAMP BATT	10A
F18	ABS PUMP	40A
F19	INTERIOR F/B BATT	60A
F20	IGNITION LOAD	60A
*F21	IGNITION COIL	15A
F22	H/L HIGH RH	10A
F23	H/L HIGH LH	10A
F24	ABS ECU IGNITION	5A
F25	-	-
F26	-	-
F27		15A

Fuse No	Function	Fuse Rating
	EMS RELAY COILS & SENSORS	
F28	EMS ECU SUPPLY	20A
F29	EMS RELAY COILS & SENSORS	15A
F30	FRONT WIPER MOTOR	20A
*F31	REAR WIPER	10A
F32	STARTER MOTOR FEEDBACK	5A
*F33	RELAY COILS	5A
*F34	IBS BATT	5A
F35	REVERSE LAMPS/BR	10A

Fuse No	Function	Fuse Rating
	AKE SWITCH	
F36	H/L LOW LH	10A
F37	H/L LOW RH	10A
F38	-	-

Note:

\* - if equipped

## Cabin Compartment Fuse Box Cover Removal Procedure

Fuse box is located inside the cover below steering column. To access the fuse box, remove cover as per procedure given below.

1. Fuse box cover is mounted on dash board with the help of lugs at the top and bottom of the cover from inside.



2. To remove the cover, gently pull the cover from upper side.

## Re-fitment Procedure

Align bottom lugs and push upper part with

respective slots on dash board and press the cover firmly.

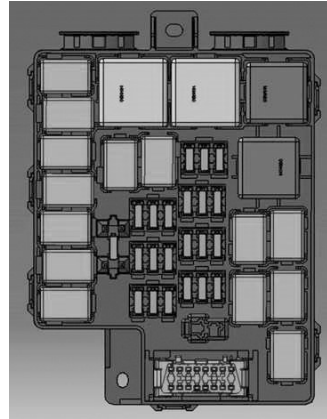

Cabin compartment fuse box

## Fuse-cabin Compartment

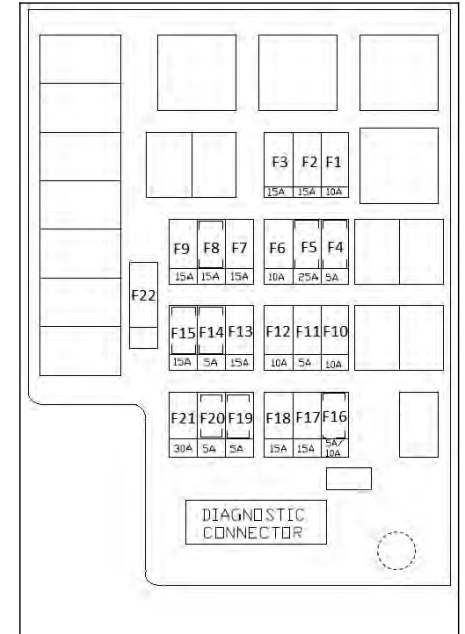

## EMERGENCY AND BREAKDOWN ASSISTANCE

Fuse No	Function	Fuse Rating
F1	TAILGATE RELEASE	10A
F2	TRANSIST/INFOTAINMENT	20A
F3	ACC BATT	15A
*F4	ACCESSORIES FUSE	5A
*F4	PEPS/BLOWER RLY	5A
*F5	HEATED REAR SCREEN BCM	25A
F6	HVAC/FATC BATT	10A
F7	BCM2-BASE/MID BCM	15A
*F8	BCM3-MID BCM	15A
F9		15A

Fuse No	Function	Fuse Rating
	BCM1-BASE/MID BCM	
F10	IGN FUSE-2	60A
F11	IMMOB/EPAS/PEPS-IGN	5A
F12	RE-CONSTRAINTS CONTROL MODULE	10A
F13	POWER SOCKET1	15A
*F14	MIRROR ADJUST MOTOR	5A
*F15	POWER SKT	15A
*F16	PEPS/ESCL ECU-BATT	10A
	RELAY COILS	5A

Fuse No	Function	Fuse Rating
F17	CLUSTER / OBD/IMMO	15A
F18	CDL	15A
*F19	KEY IN	5A
*F20	AC BLOWER POSITION	5A
F21	BLOWER MOTOR	30A
*F22	RPAS	5A

**Note:**

\* - if equipped



**EMERGENCY AND BREAKDOWN ASSISTANCE****BULB SPECIFICATION**

Sn	Description	Rating	Type	Qty.
1	HIGH BEAM	12V, 55W	H1	2
2	LOW BEAM	12V, 55W	H7	2
3	TURN SIGNAL FRONT	12V, 21W	PY21W	2
4	POSITION BULB	12V, 5W	W5W	2
5	SIDE REPEATER LAMP	12V, 5W	W5W	2
6	TURN SIGNAL (BSO)	12V, 16W	WY16W	2
7	STOP SIGNAL (BSO)	12V, 21W	P21W	1
8	POSITION SIGNAL (BSO)	12V, 5W	W5W	1
9	POSITION SIGNAL (BSO)	12V, 5W	W5W	1
10	REVERSE SIGNAL LH (ON TAIL GATE)	12V, 21W	P21W	1
11	HIGH MOUNTED STOP LAMP (CHMSL)	12V, 2W	LED	2
12	FRONT FOG LAMP	12V, 35W	H8	2
13	REAR FOG LAMP LH SIDE	12V, 21W	P21	1
14	REGISTRATION PLATE LAMP	LED	LED	2
15	ROOF LAMP (BULB)	W5W +W5W 12V, 10W		2
16	ROOF LAMP	LED	LED	1
17	LOAD AREA & GLOOVE BOX LAMP	12V, 5W	W5W	2
18	DRL	LED	LED	2
19	FOOTWELL ILLUMINATION	LED	LED	2

## EMERGENCY AND BREAKDOWN ASSISTANCE

---

Sn	Description	Rating	Type	Qty.
20	CUBBY ILLUMINATION	LED	LED	1
21	CENTER FASCIA ILLUMINATION	LED	LED	1

### Head Lamp Bulb Replacement

#### WARNING

- Do not run the engine when you change bulbs.
- If the engine has been running just prior to replacing bulbs in the headlight housing, please keep in mind that components in the engine compartment will be hot.

#### NOTE

*Your vehicle's headlamps have replaceable halogen bulbs.*

### Replacing The Low Beam Bulb

1. Lift the bonnet to access the bulbs.

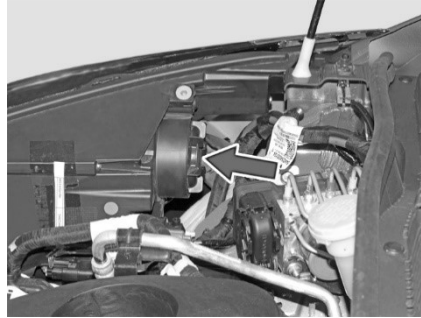

2. Remove the Bulb Access cover by rotating as per the direction arrow shown on the cover.
3. Press the pin and pull the connector from the bulb.
4. To free the headlamp bulb from the socket, press and swing the retaining spring and pull it straight back.
5. Pull out the bulb from the socket.
6. Insert the new bulb (without touching the glass) into the socket.

7. Move the retaining spring up and push it slightly until it locks properly.
8. Refit the connector in to the Bulb & rotate the Bulb Access Cover as per the direction arrow shown on the cover.

#### WARNING

- It is dangerous if a halogen bulb breaks. These bulbs contain pressurized gas and if broken, will explode causing serious injury by the flying glass.
- Halogen bulbs can break if the glass portion is touched with bare hands, body oil could cause the bulb to heat unevenly and explode when lit.
- Never touch the glass portion of the bulb with your bare hands and always wear eye protection when handling or working around halogen bulbs. Always keep halogen bulbs out of the reach of children.

## EMERGENCY AND BREAKDOWN ASSISTANCE

### 24 X 7 ROAD ASSISTANCE

Dear Customer,

It is our responsibility and our endeavor to ensure that you have our complete service backup if ever, wherever and whenever you need the same. When you have a road network that spans wide area, the probability of a breakdown happening within hailing distance of a TATA MOTORS Authorized Workshop is very low.

It is precisely for this reason, we have tied up with TVS AA, who will provide breakdown assistance including towing to the nearest TATA MOTORS Authorized Workshop through their Authorized Service Providers (ASP).

The 24X7 On Road Assistance Program shall be automatically available to your vehicle for the duration of Warranty period. The program shall also be available, if you avail the same post warranty.

### Response Time \*\* for the On Road Assistance Program

Within city Limits	60 minutes
On state or National Highways	90 minutes
Ghat Roads and other places	120 minutes +/-

\*\* (The response time will depend on the location, terrain, traffic density and the time of the day.)

### Standard Procedure When Calling for On Road Assistance in Case of a Breakdown:

- Dial the toll free help line number – **1800 209 8282**
- Identify your vehicle with the Vehicle chassis number that is available in the Owner's Manual.
- Explain your exact location with landmarks and tell us about the problem you face with the vehicle.
- Park your vehicle on the edge of the road, open the bonnet and put on the hazard warning signal.

- Place the advance warning triangle supplied with the vehicle approx. 3 m from the vehicle in the direction of on-coming traffic.



### Coverage Under 24 X 7 on Road Assistance Program

- I. The **24x7 On Road Assistance** Program Service covers the following services on your vehicle during warranty period.
- Wheel change through spare wheel.
  - Arrangement of fuel. (Fuel cost will be chargeable at actual cost).
  - Re-opening the vehicle in cases of key lock out.
  - Rectification of electrical problems related to battery, fuses etc.

## EMERGENCY AND BREAKDOWN ASSISTANCE

- On spot repairs for complaints reparable at site. ^
- Vehicle to vehicle towing or winching & towing for non-accident cases up to the nearest TATA MOTORS Authorized Dealer/Service Center. Towing charges at actual cost beyond the same to be paid to the ASP in cash. (Any ferry or toll charges levied in relation to the vehicle being towed to be paid by the customers in actuals in cash).

For accident cases, towing charges to be borne by the customer.

**II. The 24x7 On Road Assistance** Program coverage on availing the 24X7 policy, post warranty is up to maximum of 6 instance of assistance in one year for both the plans- Basic and Premium. In the premium plan, this includes 2 instances of towing up to the nearest TATA MOTORS Authorized Dealer/Service Center.

### Exclusions

#### **24 X 7 On Road Assistance Program does not Apply to**

- Cost of parts consumables and labor for such repairs not covered under warranty\*. These charges are to be settled with ASP in cash.
- Toll or ferry charges paid by ASP in reaching to the breakdown site to be settled with ASP in actuals in cash.
- Cases involving accident, fire, theft, vandalism, riots, lightning, earthquake, windstorm, hail, tsunami, unusual weather conditions, other acts of God, flood, etc.
- Vehicles that are unattended, un-registered, impounded or abandoned.
- Breakdown/defects caused by misuse, abuse, negligence, alterations or modifications made to the vehicle.
- Lack of maintenance as per the maintenance schedule as detailed in the owner's manual.
- Cases involving racing, rallies, vehicle testing or practice for such events.

### Disclaimer

- The Service is not available in Lakshadweep.
- \*\*The reach time is indicative & the actual reach time will be conveyed by the call center at the time of breakdown call.
- The reach time can vary depending on the traffic density & time of the day.
- The reach time indicated does not account for delays due to but not limited to acts of God, laws, rules & regulations for time being in force, orders of statutory or Govt. authorities, industrial disputes, inclement weather, heavy down pour, floods, storms, natural calamities, road blocks due to accidents, general strife and law & order conditions viz. fire, arson, riots, strikes, terrorist attacks, war etc.
- \* The decision for free of charge repairs will be as per the warranty policy & procedures of TATA MOTORS PASSENGER VEHICLE LIMITED. and as per the interpretation of the same by ASP. You will be duly informed by the ASP & call center for the change applicable if any.

## **EMERGENCY AND BREAKDOWN ASSISTANCE**

---

- ^ On spot repairs at breakdown site shall depend on nature of complaints & will be as per the discretion of the ASP.
- All charges wherever applicable need to be settled directly with the ASP.

### **Exclusion of Liabilities**

- It is understood that TATA MOTORS shall be under no liability whatsoever in respect of any loss or damage arising directly or indirectly out of any delay in or non-delivery of, defect/deficiency in service/parts provided by ASP.
- In case vehicle cannot be repaired on-site, customers are advised to use the towing facility for taking their vehicle to the nearest TATA MOTORS authorized workshop only. In no condition shall the vehicle be towed to any unauthorized workshop. TATA MOTORS will not be responsible for any repairs carried out in such unauthorized workshop.
- Customer are advised to take acknowledgment from the ASP for the list of accessories/extra fittings and other belongings in the vehicle as well as the current condition related to dents/scratches break-ages of parts/fitments of the vehicle at the time of ASP taking possession of the vehicle & to verify these items when delivery is taken back by them, Claim for loss of or damage to items, if any should be taken up with ASP directly. TATA MOTORS shall not be responsible for any such claims, damages/loss or any deficiency of service of the ASP.
- Vehicles will be handled, repaired & towed as per the customer's risk & TATA MOTORS shall not be liable for any damages / claims as a result of the same.
- Services entitled to the customers can be refused or cancelled on account of abusive behavior, fraudulent representation, malicious intent and refusal to pay the charges for any charges related services and spare parts during service or on previous occasions on part of the customer.

- On site repairs may be temporary in nature. The completion of repairs does not certify the road worthiness of the vehicle. The customer is advised to ensure temporary re-pairs carried out on-site is followed by permanent repairs at a TATA MOTORS Authorised Dealer/Service Center at the earliest. Terms and conditions and service coverage, exclusions etc. are subject to change without notice

**MAINTENANCE AND SERVICE**

Periodic maintenance is essential for ensuring long trouble free performance.

Have your vehicle serviced regularly from TATA MOTORS Authorized Dealer/Service Center.

There is a large network of TATA MOTORS Authorized Service Centre to help you with their professional servicing expertise. Scheduled maintenance information is provided which makes tracking routine service easy.

The following checks can be carried out between the recommended scheduled maintenance services. Take help of our authorized service center for assistance.

- Engine oil level
- Engine coolant level
- Brake fluid level
- Washer fluid level checking & top-ping up
- Battery electrolyte level
- Tyre inflation pressure including spare wheel

** NOTE**

*Refer "Opening and Closing" section for engine bonnet opening.*

** WARNING**

- Be careful not to touch a hot engine, exhaust manifold and pipes, muffler, radiator and water hoses.
- Do not work on a vehicle with the engine running in an enclosed space, unless you are sure of enough ventilation.
- Keep all open flames and other burning material (such as cigarettes) away from the battery and all fuel related parts.

If you need to do any work inside the engine compartment,

- Switch off the ignition
- Never reach into the area where there is a risk of danger from moving components, such as the fan rotation area.

- Keep clothing away from moving parts.

## MAINTENANCE

---

### ENGINE COMPARTMENT - DIESEL

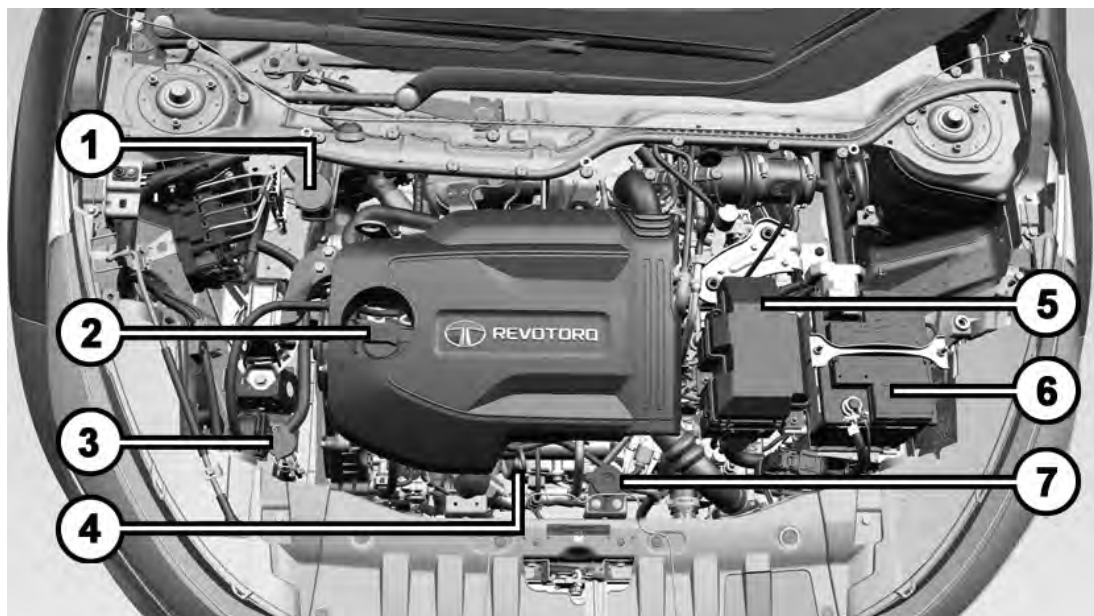

- 1. Brake fluid reservoir
- 2. Engine oil filling cap
- 3. Windshield washer container

- 4. Dipstick - Engine oil
- 5. Fuse box
- 6. Battery

- 7. Radiator cap



ENGINE COMPARTMENT- PETROL (NA Engine)

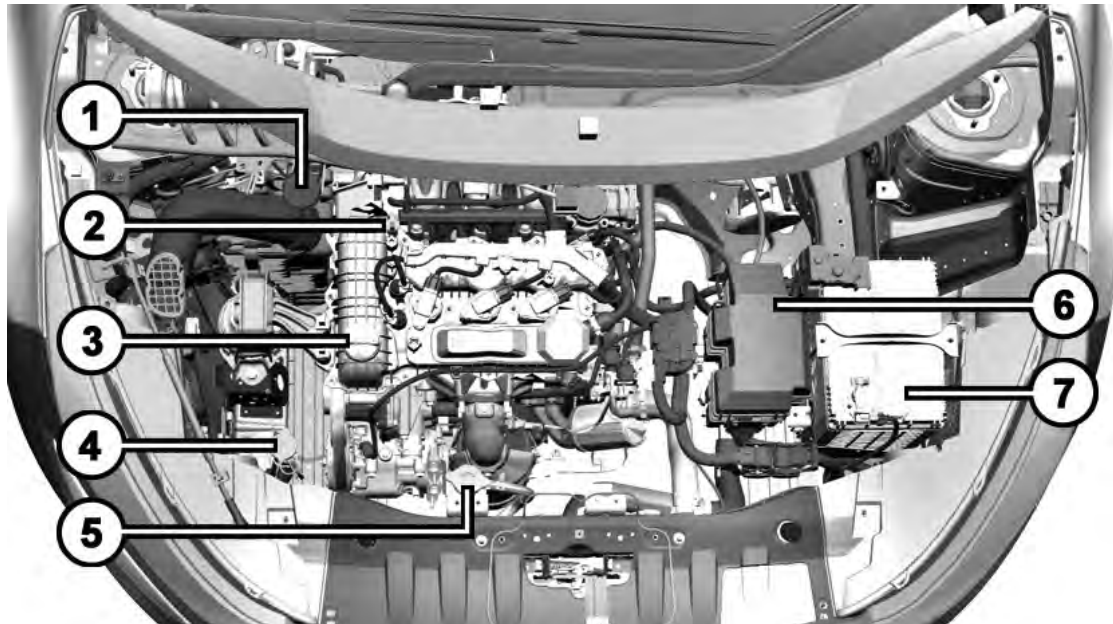

- 1. Brake fluid
- 2. Dipstick - Engine oil
- 3. Engine oil filling cap

- 4. Windshield washer container
- 5. Radiator cap
- 6. Fuse box

- 7. Battery

## MAINTENANCE

### ENGINE COMPARTMENT - PETROL (TC Engine)

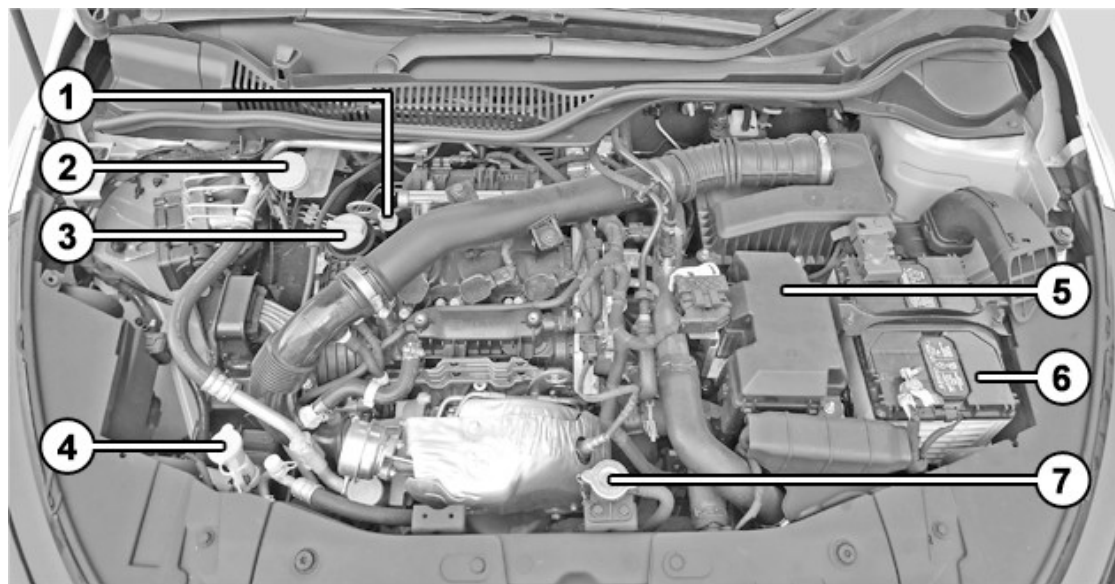

1. Dipstick - Engine oil
2. Brake fluid reservoir
3. Engine oil filling cap
4. Windshield washer container

5. Fuse box
6. Battery
7. Radiator cap

ENGINE OIL LEVEL



Dipstick location Engine oil (Diesel)



Dipstick location Engine oil (NA Petrol)

Dipstick location Engine oil (TC Petrol)



Warm up the engine to normal operating temperature.

Turn it 'OFF' and wait for 5 minutes for the oil to return to the oil pan. Be sure the vehicle is on a level surface.

Take out the dipstick, wipe it clean, and reinsert it fully. Pull it out again and examine the oil level. It should be between 'MIN' and 'MAX' level. If not, top up with recommended engine oil.

**NOTE**

*The oil consumption depends upon the driving style and the conditions under which the vehicle is used.*

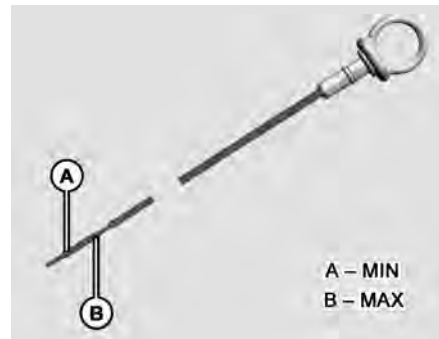

Dipstick (Petrol)

## MAINTENANCE

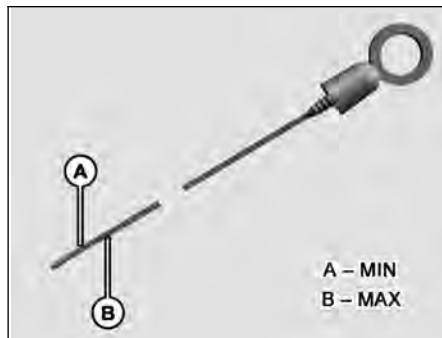

Dipstick (Diesel)

### **i** NOTE

Do not remove the filler cap when the engine is running.

Do not add oil above than the MAX. mark. Oil level above the MAX. mark may cause engine damage.

**For location of Engine oil filling cap and dip stick, please refer image of the respective Engine Compartment.**

## BRAKE FLUID LEVEL



Brake fluid reservoir (Diesel)

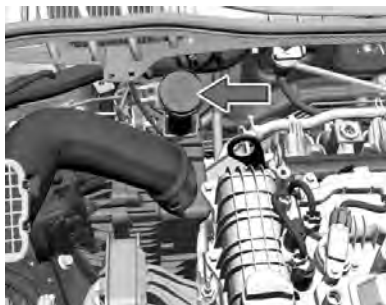

Brake fluid reservoir (Petrol)



Brake fluid reservoir (TC Petrol)

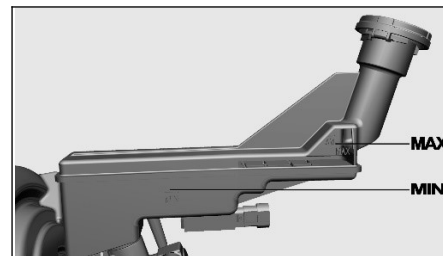

Brake fluid level

The level of the brake fluid should be between the 'MIN' and 'MAX' marks provided on the side of the brake fluid container. If the level falls below the 'MIN' mark, add recommended brake fluid.

## **i** NOTE

*Do not allow brake fluid to make contact with the skin or eyes.*

*Do not allow brake fluid to splash or spill on the paint surface as it will damage the paint. In case of spillage, wipe it off immediately.*

**For location of Brake Fluid Container and filling cap, please refer respective Engine Compartment.**

## ENGINE COOLANT LEVEL

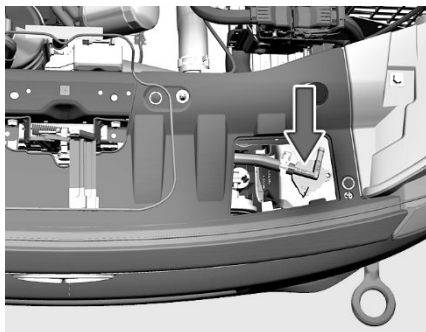

Examine whether the coolant level is between the 'MIN' and 'MAX' marks provided on the coolant reservoir.

When the coolant level is low, top up with recommended coolant through filler of No loss tank until the level approaches the max level line. Refer 'Technical information' section.

## **i** NOTE

*In case of emergency, a large amount of water without engine coolant may be added in order to reach a vehicle service location.*

Whenever coolant has been added, the coolant level in the coolant reservoir should be checked the next few times you drive the vehicle to confirm correct level.

**For location of Engine coolant container and filler cap, please refer image of Engine Compartment.**

## **i** NOTE

*Topping up of the coolant should be done in the auxiliary tank only.*

Make sure that only TATA MOTORS recommended coolant is used. Mixing of different coolants may harm your engine's cooling system and its components. Do not add extra inhibitors or additives to the coolant. These can be harmful and compromise the corrosion protection of the engine coolant.

## MAINTENANCE

### WARNING

The engine cooling system is pressurized, particularly when the engine is warm. When opening the cap, you could be scalded by hot coolant spraying out. There is a risk of injury.

Let the engine cool down before opening the cap. Wear eye and hand protection when opening the cap. Open the cap slowly half a turn to allow pressure to escape.

### WINDSHIELD WASHER FLUID LEVEL



Examine if there is washer fluid in the tank. Fill it if necessary. Use a good quality windshield washer fluid, diluted with water as necessary.

### NOTE

*Do not use detergent or any other additive in the windshield washer reservoir. This can severely impair visibility when sprayed on the windshield, and can also damage your vehicle's paint.*

*Do not operate washer motor with no fluid in washer tank, washer motor will be damaged*

***For location of Windshield Washer Container and filling cap, please refer image of the respective Engine Compartment.***

### BATTERY

- Examine the battery for electrolyte level against the marking on the battery outer case.
- Examine the battery terminals for corrosion (a white or yellowish powder). To remove it, wash the terminals with a solution of baking soda. It will bubble up and turn brown.
- When this stops, wash it off with plain water. Dry off the battery with a cloth or paper towel.
- Apply petroleum jelly to the terminals to prevent further corrosion.
- Use a proper wrench to loosen and remove cables from the terminals.
- Always disconnect the negative (-ve) cable first and reconnect it last.
- If your vehicle is equipped with Battery Sensor, then disconnect only the Sensor Output Cable. Do not remove the Sensor, Sensor connector completely as this will result in the loss of sensor function temporarily. Sensor functionality will be restored when the Vehicle

is parked for 3 hours without any operation.

- Clean the battery terminals with a terminal cleaning tool or wire brush.
- Reconnect and tighten the cables, coat the terminals with petroleum jelly.
- Make sure that the battery is securely mounted.
- If you need to connect the battery to a charger, disconnect both cables to prevent damage to the vehicle's electrical system.
- If your vehicle is equipped with Battery Sensor, connect the jump start leads on output terminal of Battery Sensor. Do not connect the jump start leads on Sensor surface or Battery terminal. This will result of function loss of Battery sensor. Refer the Battery Sensor image for do's and don'ts.

***For location of battery, please refer image of the respective Engine Compartment***

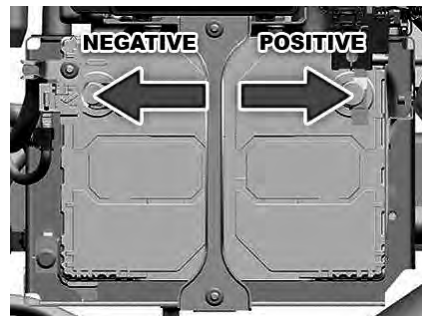

#### **NOTE**

*Use only authorized Battery recommended by TATA Motors. Use of any other unauthorized Battery will result in malfunction of the ISS operation.*

#### **NOTE**

- *During normal operation, the battery generates gas which is explosive in nature. A spark or open flame can cause the battery to explode causing very serious injuries.*
-

## MAINTENANCE

- *Keep all sparks, open flames and smoking materials away from the battery.*
- *The battery contains sulphuric acid (electrolyte) which is poisonous and highly corrosive in nature. Getting electrolyte in your eyes or on the skin can cause severe burns. Wear protective clothing and a face shield or have a skilled technician to do the battery maintenance.*

### SPARK PLUG (PETROL)



For NG NA Engine

Spark Plug	Number	Gap
Federal Mogul (Champion)	RER8MC	0.8 to 0.9 mm

For NG TC Engine

Spark Plug	Number	Gap
BOSCH	YR5ME0	0.78 to 0.8 mm

Tightening Torque - 25Nm

### **i** NOTE

*Use spark plug of recommended make & type for replacement.*



## TYRES



1	Under inflation	Excessive side tread wear
2	Correct tyre pressure	Uniform wear
3	Over inflation	Excessive center tread wear

### Inflation

Do a check of the tyre pressure and the tyres condition periodically.

Examine the pressure in the tyres when they are cold.

Keep the correct pressure in the tyres for the best combination of riding com-fort, handling, tyre life and optimum performance.

Over inflation of tyres makes the vehicle ride bumpy and harsh. Tyres are more prone to uneven wear and dam-age from road hazards.

Under inflated tyres reduce comfort, affects handling and increases the operating temperature, which can result in failure. They also cause uneven wear and bring down the performance of the car.

#### **i** NOTE

*Every time you check inflation pressure, you should also examine tyres for uneven wear, dam-age and trapping of foreign objects in the treads and wear.*

### Recommended Tyre Pressure

Tyre Size	Front (psi/bar)	Rear (psi/bar)
165/80 R14	35 / 2.4	35 / 2.4
185/60 R16	35 / 2.4	35 / 2.4
195/55 R16	35 / 2.4	35 / 2.4
185/65 R15	35 / 2.4	35 / 2.4

For ride comfort, refer below pressure table

Tyre Size	Front And Rear	
	Laden	Unladen
165/80 R14	35	35
185/60 R16	35	32
195/55 R16	35	32
185/65 R15	35	35

#### **i** NOTE

*This is for reference. Kindly refer Tyre pressure as indicated on tyre pressure sticker provided on vehicle.*

## MAINTENANCE

### Tyre Pressure Sticker Location

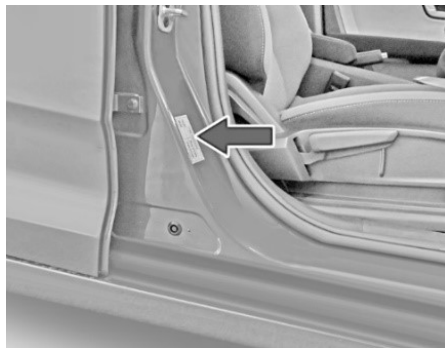

### Tyre Rotation

To increase tyre life rotate the tyre at specified intervals or earlier depending on the operation of vehicle. The illustrations shows how to rotate tyres.

### For 165/80 R14 Tyres

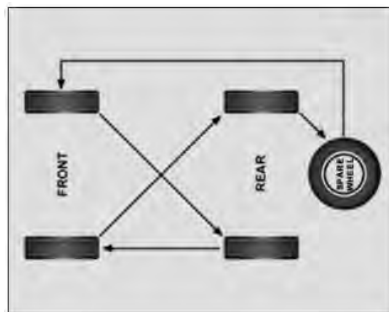

### For Tyre with Temporary Spare Wheel (if available)

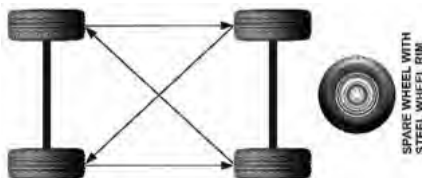

### **i** NOTE

- Do not use spare wheel for tyre rotation, in case of temporary spare wheel used.
- Two or more temporary tyres should not be used on one vehicle.
- Tyre pressure of temporary wheel is to be checked at least once in a month.

### Spare Wheel Specification

165/80 R14 for all variants

### Wheel Covers (if available)

Insert a piece of cloth between the spokes of the wheel cover and pull it outwards. Take out detached wheel cover from the wheel rim.

When installing the cover, make sure that it is positioned so that it does not cover the air filling valve. Apply equal pressure at the circumference of the wheel cover to fix it in the wheel rim.

** NOTE**

*Do not use any sharp tools (such as screw driver etc.) to remove the wheel cover.*

**Wheel Alignment**

Incorrect wheel alignment causes excessive and uneven tyre wear. Check wheel alignment at specified intervals

**Wheel Balancing**

Wheels of your vehicle are balanced for better ride comfort and longer tyre life. Balancing needs to be done whenever tyre is removed from rim.

** WARNING**

If the vehicle vibrates abnormally on a smooth road, have the wheel balanced done immediately.

**Special Care for Tubeless Tyres**

- When you remove the tyre and install it back on the rim, take pre-cautions not to damage tyre bead. Use tyre removal and assembly machines. Damage or cut on tyre bead may cause gradual loss of air and deflation of tyre.
- Do not scratch the inner surface of tubeless tyre with metallic or sharp object. Tubeless tyres are coated with impermeable layer of rubber from the inner surface which holds the air in the tyre. Removal of this layer due to scratching may cause gradual loss of air and deflation.
- If wheel rim gets damaged in service, get the wheel rim repaired/ replaced immediately. Running the vehicle with damaged rim may cause deflation of tyre and subsequent dislodging of tyre from rim.
- Keep the recommended inflation pressure. Over-inflation, in particular, may cause puncture or bursting of tyre.

** NOTE**

*Life and wear pattern of tyres depends on various parameters like tyre pressure, wheel alignment, wheel balancing, tyre rotation, etc. It also largely depends on vehicle speed, load carried, usage, driving habits, road conditions, tyre quality, etc. In case fault is suspected to be due to poor quality of tyres, the same may be taken up with concerned tyre manufacturer.*

## MAINTENANCE

### SMART KEY BATTERY REPLACEMENT (for PEPS variant)

#### Procedure

1. Open rear side of key (battery cover).



2. Replace with new battery in the smart key battery slot.
3. Ensure that the "+" symbol on the battery is facing upwards. The correct polarity is shown on the battery cover.
4. Close the battery cover.
5. Make sure that the key cover is intact properly.

#### **i** NOTE

- Use CR 2032 battery only.
- An inappropriately disposed battery can be harmful to the environment and human health. Dispose the battery according to your local law(s) and regulation.

### WEARABLE KEY BATTERY REPLACEMENT PROCEDURE

Battery status of the wearable key fob:

- If customer presses the driver door handle switch or tailgate switch for 2-3 times with valid wearable and if the passive entry is not working, the wearable key fob's battery is low.
- As standby he can use Smart Key (UID) or emergency key for entry
- Customer to contact nearby dealer or service station for battery replacement

#### Battery Specification

- Lithium Battery CR1632
- Voltage 3V
- Make: Panasonic, Renata

#### **i** NOTE

*Battery life is 10 months or 25,000 PKE cycles (whichever comes earlier).*

#### Battery Replacement

- Remove the screws from backside of wearable key fob.

## MAINTENANCE

### ON BOARD DIAGNOSTIC (OBDII) SYSTEM

On board Diagnostics or OBD, is an automotive term referring to a vehicle's self-diagnostic and reporting capability. The OBD system allows continuous diagnosis of the components of the vehicle correlated with emissions. This system warns the driver, by turning "ON" the Malfunction Indication lamp (MIL) on the instrument cluster, when a fault causes emission levels to increase.

The OBD system also has a diagnostic connector that can be interfaced with appropriate diagnostic tools, which makes it possible to read the fault codes stored in the Electronic Control Unit, together with a series of specific parameters for Engine operation and Diagnosis. This check can also be carried out by the traffic police.

On board diagnostic located in Engine compartment fuse box. (Refer below image)

- Remove back-cover
- Remove battery from wearable key
- Place new battery
- Put the back cover and screw it with all the four screws.



## MAINTENANCE

---

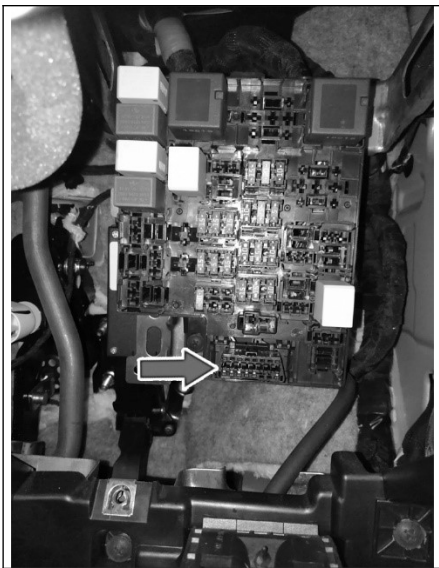

*Location of on board diagnostic (OBD II)*

**SERVICE INSTRUCTIONS**

The TATA ALTROZ has been manufactured to give you economical and trouble free performance. To achieve this, please follow the instructions as stated.

Your vehicle is entitled to three free services (labour only). The free service coupons are attached to the sales invoice. Please present these coupons to the servicing dealer while availing free services.

1st free service - At 1,000-2,000km. OR 2 months, whichever is earlier.

2nd free service - At 7,000-8,000km. OR 6 months, whichever is earlier.

3rd free service - At 14,500-15,500km. OR 12 months, which-ever is earlier.

All services other than free services are chargeable.

Servicing of the vehicle can be done at any TATA MOTORS Authorised Dealer Workshop or TATA MOTORS Authorised Service Centre (TASC).

Warranty claims can be settled by any TATA MOTORS Authorised Dealer Workshop or TATA MOTORS Authorised Service Centre (TASC).

## MAINTENANCE

### SERVICE SCHEDULE

Note : # - Kms or months whichever occurs earlier

S n	Operation	Km	Pdi	1500	7500	15000	22500	30000	37500	45000	52500	60000	67500	75000	82500	90000	97500	105000	112500	120000	127500	135000	142500	150000	
		Months	0	2	6	12	18	24	30	36	42	48	54	60	66	72	78	84	90	96	102	108	114	120	
<b>GENERAL</b>																									
1	Wash the vehicle & Clean Condenser Fins	Every Service	•	•	•	•	•	•	•	•	•	•	•	•	•	•	•	•	•	•	•	•	•	•	•
2	Check & Top up Fluids (If required): Transaxle Oil, Coolant, Brake Fluid, Battery Electrolyte, Wind Screen washer fluid	Every Service	•	•	•	•	•	•	•	•	•	•	•	•	•	•	•	•	•	•	•	•	•	•	•
3	Check Fuel Lines for Leakages	Every Service	•	•	•	•	•	•	•	•	•	•	•	•	•	•	•	•	•	•	•	•	•	•	•
4	Check and Capture all DTC's Clear all faults and Erase the Codes.	Every Service	•	•	•	•	•	•	•	•	•	•	•	•	•	•	•	•	•	•	•	•	•	•	•
5	Check condition of Rubber bushes/ parts in lower link, front & rear coil spring seats, front & rear bump stoppers, anti-roll bar, rear twist beam,	7.5K / 6M				•	•	•	•	•	•	•	•	•	•	•	•	•	•	•	•	•	•	•	•



## MAINTENANCE

S n	Operation	Km	Pdi	1500	7500	15000	22500	30000	37500	45000	52500	60000	67500	75000	82500	90000	97500	105000	112500	120000	127500	135000	142500	150000		
		Months	0	2	6	12	18	24	30	36	42	48	54	60	66	72	78	84	90	96	102	108	114	120		
	front & rear dampers, rubber boot/dust cover/bellow in rack & pinion, steering and suspension ball joints, steering column. Replace if necessary (First at 15K/12M then at every service).																									
6	Check & Replace if found damaged —Exhaust hanger , Suspension bushes	30K/24 M						•				•				•					•				•	
7	Check All door latch & striker operations , Adjust & Apply grease If required	15K/12 M				•		•		•		•		•		•		•		•		•		•		
8	Check for all bolts & nuts	7.5K / 6M			•	•	•	•	•	•	•	•	•	•	•	•	•	•	•	•	•	•	•	•	•	
<b>ENGINE (Diesel)</b>																										
1	Clean air filter element (more frequently for vehicle operating in severe condition)	7.5K / 6M			•	•	•	•	•	•	•	•	•	•	•	•	•	•	•	•	•	•	•	•	•	

## MAINTENANCE

S n	Operation	Km	Pdi	1500	7500	15000	22500	30000	37500	45000	52500	60000	67500	75000	82500	90000	97500	105000	112500	120000	127500	135000	142500	150000	
		Months	0	2	6	12	18	24	30	36	42	48	54	60	66	72	78	84	90	96	102	108	114	120	
2	Replace air filter element (@ 15K for Vehicle operating in severe condition)	30K / 24M						•				•				•					•				•
3	Change engine oil and Oil filter	15K / 12M				•		•		•		•		•		•		•		•		•		•	•
4	Drain water from Fuel Filter Bowl	15K / 12M				•		•		•		•		•		•		•		•		•		•	•
5	Replace Fuel filter assembly. Replace based on Lamp status only.	# / 24 M																							
6	Check AC & Alternator belt condition visually, replace if found damage	15K / 12M				•		•		•		•		•		•		•		•		•		•	•
7	Check timing belt visual condition, replace if found damage.	# 105K / 24M																•							
8	Change coolant	# 60K / 36M										•									•				
9	Replace timing drive kit (Timing belt, Auto tensioner	# 150K / 60M																							•

## MAINTENANCE

S n	Operation	Km	Pdi	1500	7500	15000	22500	30000	37500	45000	52500	60000	67500	75000	82500	90000	97500	105000	112500	120000	127500	135000	142500	150000		
		Months	0	2	6	12	18	24	30	36	42	48	54	60	66	72	78	84	90	96	102	108	114	120		
	and Idler)																									
<b>ENGINE (Gasoline) &amp; TC Engine</b>																										
1	Clean air filter element (more frequently for vehicle operating in severe condition)	15K / 12M				•		•		•		•		•		•		•		•		•		•		
2	Change engine oil and Oil filter	15K / 12M				•		•		•		•		•		•		•		•		•		•		
3	Gasoline - Replace Gasoline Fuel Filter	75K/ 60M												•											•	
4	Change Spark plugs - Natural Aspirated Engine	45K/ 36M								•						•							•			
5	Change Spark plugs - Turbocharger Engine	30K/ 24M						•				•				•					•				•	
6	Check accessory belt condition visually, replace if found damage	15K/ 12M				•		•		•		•		•		•		•		•		•		•		
7	Replace air filter element (more frequently for vehicle	45K/ 36M								•						•							•			

## MAINTENANCE

S n	Operation	Km	Pdi	1500	7500	15000	22500	30000	37500	45000	52500	60000	67500	75000	82500	90000	97500	105000	112500	120000	127500	135000	142500	150000		
		Months	0	2	6	12	18	24	30	36	42	48	54	60	66	72	78	84	90	96	102	108	114	120		
	operating in severe condition)																									
8	Change coolant	# 60K/36M										•								•						
<b>BRAKES</b>																										
1	Check front brake pads & rear brake linings. Replace if necessary	15K/12M				•		•		•		•		•		•		•		•		•		•		
2	Replace brake fluid, Check brake system components for Leakages	# 45K/24M								•						•							•			
3	Inspect and if necessary adjust handbrake setting	15K/12M				•		•		•		•		•		•		•		•		•		•		
<b>WHEELS &amp; TYRES</b>																										
1	Check & adjust wheel alignment	# 15K/18M				•		•		•		•		•		•		•		•		•		•		
	(For severe usage, above checks to be done at every 5,000 km or after every se					•		•		•		•		•		•		•		•		•		•		•

## MAINTENANCE

S n	Operation	Km	Pdi		1500	7500	15000	22500	30000	37500	45000	52500	60000	67500	75000	82500	90000	97500	105000	112500	120000	127500	135000	142500	150000		
		Months	0	2	6	12	18	24	30	36	42	48	54	60	66	72	78	84	90	96	102	108	114	120			
	vere usage event)																										
2	Check for Tyre pressure, condition & rotate	# 7.5 K/ 12M			•	•	•	•	•	•	•	•	•	•	•	•	•	•	•	•	•	•	•	•	•	•	
<b>TRANSAXLE (Petrol &amp; Diesel)</b>																											
1	Replace transaxle oil	75K/ 60M														•										•	
<b>ELECTRICAL</b>																											
1	Check specific gravity of battery electrolyte	7.5K/6M			•	•	•	•	•	•	•	•	•	•	•	•	•	•	•	•	•	•	•	•	•	•	•
2	Check headlamp focusing	15K/ 12M				•		•		•		•		•		•		•		•		•		•		•	
<b>A.C. SYSTEM</b>																											
1	Clean filter and check Air-conditioning / HVAC System for satisfactory performance	Every Service	•	•	•	•	•	•	•	•	•	•	•	•	•	•	•	•	•	•	•	•	•	•	•	•	•

## **MAINTENANCE**

---

### **VEHICLE PARKING FOR LONG DURATION (NON-USE MAINTENANCE)**

If you want to park your vehicle at one place for long duration, following care is to be taken:

1. Park the vehicle in covered, dry and if possible well-ventilated premises. Engage a gear.
2. Remove the battery terminal cables (first remove the cable from the negative terminal). Ensure that battery is fully charged.
3. Use wheel chocks to prevent movement of the car.
4. Clean and protect the painted parts using protective wax.
5. Clean and protect the shiny metal parts using commercially available special compounds.
6. Sprinkle talcum powder on the rubber windscreen wiper and lift them off the glass.
7. Slightly open the windows.
8. Cover the vehicle with a cloth or perforated plastic sheet. Do not use sheets of imperforated plastic as they do not allow moisture on the vehicle body to evaporate.
9. Inflate the tyres to 0.5 bar above the normal specified pressure and check it at regular intervals.
10. Check the battery charge every six weeks.
11. Do not drain the engine cooling system.

**FUEL SPECIFICATION**

**Fuel (diesel)**

Normal grade BS VI compliant diesel conforming to IS1460 :2017 or equivalent is recommended to be used as fuel.

Do not use premium diesel available in the market for like extra premium / Turbojet etc.

**Recommended Fuel Specification**

Parameter	Unit	Bs Vi
Cetane Number (min)	CN	51
Sulphur content	Mg/kr	10
Lubricity (HFRR)	Micron	460

***i* NOTE**

*Where oxidation catalytic converter is fitted, it is mandatory to use Diesel fuel with sulphur contents as given above. Use of any other diesel fuel can in*

*crease the pollutants.*

**Fuel (petrol)**

Unleaded gasoline conforming to IS 2796:2017 is recommended to be used as fuel. It is always recommended to use correct fuel to get optimum emission performance.

***i* NOTE**

*Always use petrol of a correct specification in a vehicle fitted with catalytic converter. Even single fill of leaded petrol will seriously damage the catalytic converter.*

## TECHNICAL INFORMATION

### LUBRICANT SPECIFICATION

Use following genuine fluids, coolants and lubricants recommended for optimum performance of your vehicle.

Item	Specification	Company	Brand	Quantity
Engine oil	0W20,SS6588	Castrol	GTX T 0W20	Petrol 3.5 L Diesel 5L
		Exxon Mobile	Mobil Super 3000 TM 0W20	
		Petronas	PETRONAS Syntium 7000 TM 0W20	
Coolant (pre-mixed Antifreeze agent + Softwater 40: 60 ratio)	Class II/JIS K2234 TATA SS7700S1	Ansycos	Puroblue	Petrol 4L (NA Engine ) Petrol 5L (TC Engine) Diesel 5
		Sunstar CCI	Golden Cruiser LLC2200NP	
		IOCL	TATA MOTORS GENUINE COOLANT KOOL PLUS	
Transaxle oil	EP80WLL (Next Gen) TATA SS6582	CASTROL	Next Generation Transmission oil EP80W	Petrol - 1.8 L Diesel - 2.1 L
		Petronas	PETRONAS TATA MOTORS Genuine -Gear oil New Gen 80 EP LL	
		IOCL	IOCL TATA MOTORS Genuine gear oil 80 WLL	
Brake fluid/ Clutch fluid	SAE J1703, DOT4	PETRONAS	Tutela Brake fluid DOT 4	As required
		Sunstar CCI	Golden Cruiser Tata Genuine Brake Fluid (DOT4)	
		CASTROL	Optional - CASTROL- Universal Brake Fluid DOT 4	
Refrigerant	R-134 A			450 ±20 gm
Compressor oil	SP10	Sandan Vikas	SP10	120 ± 15cc



**TECHNICAL INFORMATION**

Parameter	Diesel	Petrol
<b>Engine</b>		
Mode/type	1.5 Common Rail Turbo Intercooled	Option I: 1.2 Revotron Petrol NA Engine Option II: 1.2 NG TC
Capacity	1497 cc	1199 cc
Max. Engine output	66 kW @ 4000 rpm	63 kW @ 6000 rpm (1.2 NG NA) 80.6 kW @ 5500 rpm (1.2 NG TC)
Max. Torque	200 Nm @ 1250 to 3000 rpm	113 Nm @ 3300 +/- 100 rpm (1.2 NG NA) 140 Nm @ 1500-5500 rpm (1.2 NG TC)
<b>Transaxle</b>		
Model	TA 5260	TA 65*
Type	Synchromesh with Overdrive	
No. of gears	5-Forward, 1- Reverse	
<b>Steering</b>		
Type	Electric Power Assisted Steering System	
<b>Brakes</b>		
Brakes	Front (Disc); Rear (Drum)	
Parking Brake	Hand Operated (Pull to Operate) on LHS of Driver	
<b>Suspension</b>		
Types	Front: Independent, lower wishbone, Mcpherson strut with coil spring Rear: Semi-independent twist beam with coil spring and shock absorber	
Shock absorber	Hydraulic; gas filled	

## TECHNICAL INFORMATION

Parameter	Diesel	Petrol
<b>Wheels and Tyre</b>		
Tyres	Option I :165/80 R14 (Radial-Tubeless); Option II :185/60 R16 (Radial-Tubeless); Option III : 195/55 R16 (Radial-Tubeless); Option IV : 185/65 R15 (Radial-Tubeless) Option V : 6.0j X 16"Alloy wheel	
<b>Fuel tank</b>		
Capacity	37 liters	
<b>Cab/body</b>		
Type	Steel Monocoque body	
<b>Electrical system</b>		
System Voltage	12 Volts (-ve earth)	
Alternator Capacity	13.5 V, 110 A	
Battery	12V, 47.5 Ah	Option I : 12V, 38 Ah Option II : 12V, 60 Ah
<b>Main Chassis dimension (in mm)</b>		
Wheel base	2501	
Track base	1510	
Track rear	1510	
Overall length	3990	
Overall height	1523	
Max. Width without ORVM	1755	

## TECHNICAL INFORMATION

Parameter	Diesel	Petrol
Max. Width with ORVM	1983	
Ground clearance (unladen condition)	165	
<b>Performance</b>		
Max Speed	166 kmph	154 kmph (1.2 NG NA) 160 kmph (1.2 NG TC)
Max. Recommended gradability	17.5	14.2
Minimum Turning Circle Dia. In meter as per IS: 12222	10	10 (1.2 NG NA) 9.5 (1.2 NG TC)
Minimum Turning Clearance circle dia. in meters	10.6	
<b>Weight (in kg)</b>		
Gross vehicle weight (Laden)	1533 (XE) 1545(XM) 1565 (XT) 1575 (XZ)	1405 (XE) 1427 (XM) 1453 (XT) 1461 (XZ)
Kerb weight (unladen)	1108 (XE) 1120 (XM) 1140 (XT) 1150 (XZ)	980 (XE) 1002 (XM) 1028 (XT) 1036 (XZ)

## TECHNICAL INFORMATION

### VEHICLE DIMENSIONS

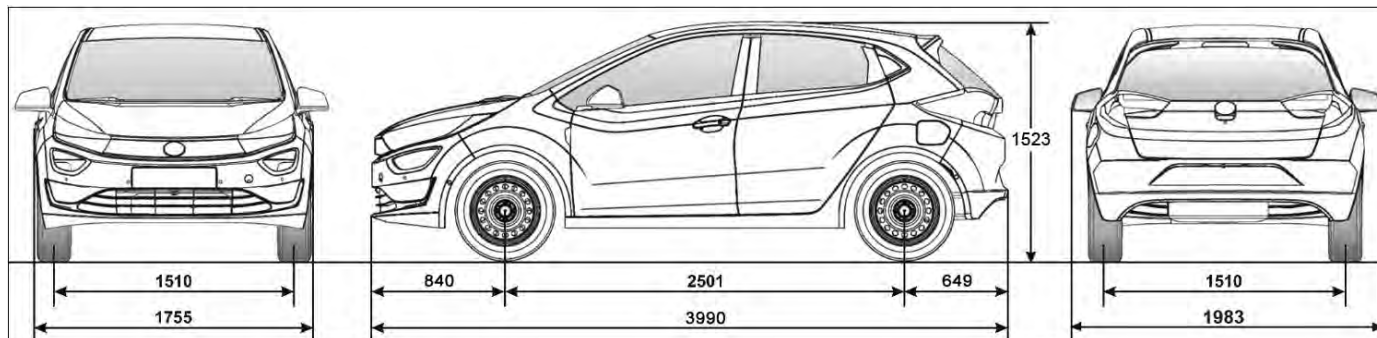

**NOTE:** Dimensions are in mm and under Unladen condition

**AGGREGATE IDENTIFICATION  
NUMBERS**



*Chassis No. punching near driver seat*

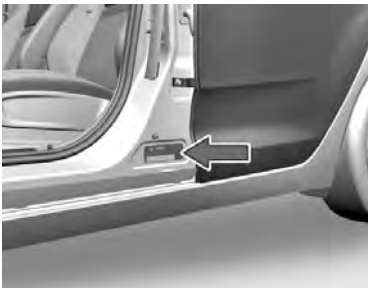

*VIN plate location near front passenger seat*



*Transaxle No. Punching (TA 5260)*



*Transaxle No. Punching (TA 65\*)*

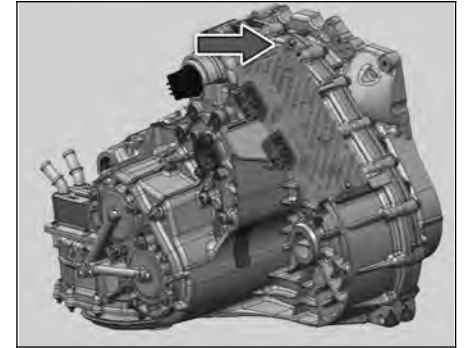

*Transaxle No. Punching (DCT)*



*Engine No. Plate - Diesel*

## TECHNICAL INFORMATION

---

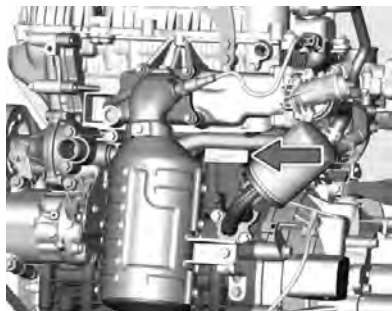

*Engine No. plate Petrol (NA)*

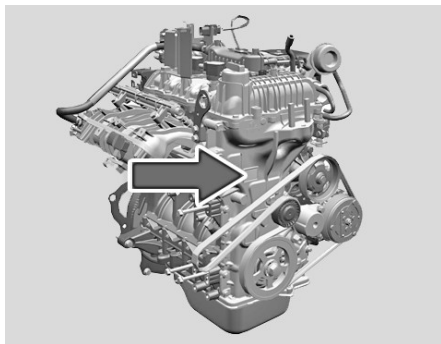

*Engine No. plate Petrol (TC)*

### CAR CARE

Your vehicle is subjected to many external influences such as climate, road conditions, industrial pollution and proximity to the sea. These conditions demand regular care of the vehicle body. Dirt, insects, bird droppings, oil, grease, fuel and stone chip-pings should be removed as soon as possible.

#### Washing

Following these tips while washing your vehicle.

Always wash your vehicle in shade and the surface is at room temperature.

Wash with mild vehicle wash soap like 'Car Shampoo' and use a soft bristle brush, sponge or soft cloth and rinse it frequently while washing to avoid scratches.

To avoid scratches, please wear soft gloves. Remove finger rings, nails, wrist watch while washing.

To remove stubborn stains and contaminants like tar, use turpentine or cleaners like 'Stain remover' which are safe for paint surfaces.

Avoid substances like petrol, diesel, kerosene, benzene, thinner, ac-acids or other solvents that cause damage to paint.

Dry your vehicle thoroughly to pre-vent any damp spots.

Rinse all surfaces thoroughly to prevent any traces of soap and other cleaners as this may lead to the formation of stains on the painted surface later.

#### NOTE

*Avoid parking the car under trees without proper cover, it will reduce the amount of bird droppings, tree sap and pollen contact on paint surface. Regularly remove the twigs, leaves and vegetation near the windshield areas, to avoid water stagnation.*

#### WARNING

Do not direct high pressure washer fluid/ water jets (Pressure above 0.5 bar) at electrical devices and connector during washing. This is to prevent malfunction / failure of electrical system due to water ingress.

After drying the vehicle, inspect it for chips and scratches that could allow corrosion to start. Apply touch up paint where necessary.

#### Cleaning of Carpets

Vacuum clean the carpet regularly to remove dirt. Dirt will make the carpet wear out faster. Periodically, shampoo the carpet to keep it looking new.

Use carpet cleaners (preferably foam type). Follow the instructions that come with the cleaner. Apply it with a sponge or soft brush. Keep the carpeting as dry as possible by not adding water to the foam.

## VEHICLE CARE AND VALUE ADDED SERVICES

### **i** NOTE

*Avoid wiping of painted surface in dry condition as it may leave scratches on the painted surface.*

### **Cleaning of Windows, Front and Rear Glasses**

Clean the windows inside and outside with commercially available glass cleaners.

This will remove the haze that builds up on the inside of windows. Use a soft cloth or paper towels to clean all glass and plastic surfaces.

### **Waxing**

Waxing and polishing is recommended to maintain the gloss and wet-look appearance of your paint finish.

1. Use good quality polish and wax for your vehicle.
2. Re-wax your vehicle when the water does not slip off the surface but collects over the surface in patches.

### **Polishing**

Polishes and cleaners can restore shine to

the painted surface that has oxidized and become dull. They normally contain mild abrasives and sol-vents that remove the top layer of the finish coat. Polish your vehicle, if the finish does not regain its original shine after using wax.

### **Interior Fabric Cleaning Tips**

1. Stains should be treated immediately. If left for a long time, they can leave a permanent mark.
2. Cleaning the stains immediately is important especially for stains, which contain artificial colors in the stain creating liquid or semisolid substance. The colorant may leave a stain if kept for longer time.
3. Stain should not be removed by rubbing. As far as possible, try to blot or lift the stain with cloth or plastic spatula and then clean the remaining stain with cloth or sponge.
4. If the stain has dried, then gently brush off the material and then press with damp cloth or sponge till it disappears.
5. Do not use household detergents to clean the fabric.

6. Always use clean cotton cloth for cleaning.

### **Paint Care**

Following guidelines will help you to protect your vehicle from corrosion effectively.

### **i** NOTE

*Avoid Spillage or Direct contact of Air freshener liquid/chemicals with painted plastic parts. These chemicals may cause damage to paint like blisters, peel off, wrinkles etc*

### **Proper Cleaning**

- In order to protect your vehicle from corrosion it is recommended that you wash your vehicle thoroughly and frequently in case:
- There is a heavy accumulation of dirt and mud especially on the underbody.
- It is driven in areas having high atmospheric pollution due to smoke, soot, dust, iron dust and other chemical pollutants.
- It is driven in coastal areas.



## VEHICLE CARE AND VALUE ADDED SERVICES

- The underbody must be thoroughly pressure washed after every three months.
- In addition to regularly washing your car, the following precautions need to be taken.

### Periodic Inspection

- Regularly inspect your vehicle for any damage in the paint film such as deep scratches and immediately get them repaired from an authorized service outlet, as these defects tend to accelerate corrosion.
- Inspect mud liners for damages.
- Keep all drain holes clear from clogging.

### Proper Parking

Always park your vehicle in shade to protect it from harsh sunlight or in a well-ventilated garage so that there is no dampness on any part of the vehicle.

### Wiper Care

To prevent damage to the wipers or windshield, do not operate the wipers when the windshield is dry.

To prevent damage to the wiper arms and other components, do not attempt to move the wipers manually

### FAST TAG

FAST TAG is pasted on front windshield from the inside. It enables Electronic toll collection.



### NOTE

*Do not attempt to rip or tamper the tag.  
It will disable the functionality of the tag*

## VEHICLE CARE AND VALUE ADDED SERVICES

---

### VALUE CARE - AMC

Value Care (AMC) is a fixed cost maintenance plan that guarantees protection against unexpected repairs & provides substantial savings through protection against inflation & price volatility of consumables during the running of the vehicle.

Our customers can choose from Value Care Gold, Value Care Silver, Promise to Protect (P2P) and Protect plus plan as per the requirement & usage to ensure hassle free, reliable & economic maintenance of the vehicle.

Coverage – Schedule Service and Wear & Tear.

#### Advantages (Customer Benefits)

- Price protection against rising prices of lubes and parts.
- A higher resale value for your vehicle.
- Peace of mind with Cashless repairs & services.
- Vehicle servicing at a workshop of your choice pan India.
- Covers Repairs including Wear & Tear parts viz. Brakes, Suspension, Wiper, Clutch, Brake Pads, Brake Liners etc.
- Covers Scheduled maintenance services including Lubricants, Parts, Wheel Alignment and Balancing Labour.
- Available at unmatched value.... Huge Savings!!!
- Savings on Goods & Services Tax whenever vehicle attend under AMC.

#### Available Offers (Types of AMC )

- Silver AMC
- Gold AMC
- Promise to Protect (P2P)
- Protect Plus



### **Silver AMC**

Value Care Silver Plan covers the following:

- Scheduled maintenance services at periodic interval of Kms for Labor, Parts & Consumables.
- 1. Change of Oil Filter, Fuel Filter, Air Filter & Sedimenter.
- 2. Change of Engine Oil, Transmission Oil.
- 3. Change of Coolant, Brake Oil & Clutch Fluid\*.
- 4. General Checkup, Wheel Alignment / Balancing (Excluding Balancing Weight).
- 5. Washing of Vehicle, Wheel greasing as applicable.

### **Gold AMC**

The value care Gold Plan extends your scheduled maintenance cover to include any normal wear and tear items identified during the scheduled service and other vehicle parts that need to replace during the period of cover arising from proper and uniform usage.

- Scheduled maintenance services at periodic interval of Kms for Labor, Parts & Consumables.

In addition to coverage mentioned under Silver AMC, the Gold AMC also covers Repairs or Replacement of Wear & Tear Items for both Parts & Labour.

1. Brake Pads, Brake Lines, Wheel Cylinders
2. Clutch Disc, Clutch Cover, Cables, Mountings.
3. Suspension Bush, Wiper Blades, Auxiliary Belt & other Wear & Tear Items
4. Washing of Vehicle, Wheel greasing as applicable.

### **Promise To Protect (P2P)**

Value Care – Promise to protect (P2P) is a maintenance plan that guarantees protection against unexpected wear & tear repairs to provide substantial saving through protection against inflation & price volatility during the running of the vehicle.

New Vehicle (under warranty vehicles) are eligible to avail this offer –Identified 13 wear & tear parts listed below Including Labour is

## VEHICLE CARE AND VALUE ADDED SERVICES

---

covered in this AMC with the price range of 11 to 14 paisa per Km . \*applicable to selected models\*

### List of Covered Parts

Clutch, Brake Pad, Brake Linings, Brake Disc, Wiper, Wheel Cylinder, Suspension Bushes, Engine Mountings, Ball Joints, Hoses, Auxiliary Belt, (Alternator & A/C Belt), Window Winder.

### Protect Plus

The value care Protect plus Plan extends your scheduled maintenance cover to include coverage of P2P. It covers Scheduled maintenance services – labour, parts & consumables + Identified 13 wear & tear parts of P2P plan Including Labour

New Vehicle (under warranty vehicles) are eligible to avail this offer.\*applicable to selected models\*.

### NOTE

- *AMC is available in the dealership from where you have purchased your vehicle.*
- *We strongly recommend purchase of AMC at time of purchase of your vehicle to get benefit for coverage of Scheduled Services and Wear & Tear parts.*
- *The Dealer Service Marketing Executive shall explain to you the Terms and conditions, Coverage and Owner's responsibility.*
- *One Time payment is to be made to avail AMC offer.*
- *P2P & Protect plus offer valid on selected models & may vary from Model to Model, Variant to Variant.*
- *Please read the offer eBooklet for further details about coverage and exclusions of various AMCs.*
- *\*Terms & condition apply.*

### Owner's Responsibility

- Proper use, maintenance and care of the vehicle in accordance with the instructions contained in the Owner's Manual and Service Booklet. The records of the same to be ensured in Owner's Manual.
- Retention of maintenance service bills.

## **VEHICLE CARE AND VALUE ADDED SERVICES**

---

I / We have been explained the Terms and conditions, Coverage and Owner's responsibility by the Dealer Service Marketing Executive.

I wish to avail /  Do not wish to avail Value care AMC policy.

**Customer's Signature**

**Dealer's Signature**

## VEHICLE CARE AND VALUE ADDED SERVICES

---

### EXTENDED WARRANTY

TATA MOTORS recommends the purchase of its extended warranty program.

**Coverage** - Mechanical + Electrical

#### Benefits

- Insures you against unforeseen break down repair bills.
- Documentation is simple and hassle free.
- Near cashless & speedy claim

#### Term

24 + 12 months or 75,000 kms whichever occurs first

OR

24 + 24 months or 1,00,000 kms whichever occurs first

OR

24 + 36 months or 1,25,000 kms whichever occurs first

Extended Warranty is available in the dealership from where you have purchased your vehicle. We strongly recommend purchase of Extended Warranty at time of purchase of your vehicle. Extended Warranty can be availed till warranty period from date of purchase of vehicle. The Dealer Service Marketing Executive shall explain to you the Terms and conditions, Coverage and Owner's responsibility.

- The 12 or 24 or 36 months extended warranty does not follow the 24 months Manufacturer's warranty.
- The extended warranty comes into force once the manufacturer's warranty expires e.g. after 24 Months.
- It is more restrictive as by the time it comes into force the vehicle is already 24 months old.



---

## VEHICLE CARE AND VALUE ADDED SERVICES

### What is Covered?

Mechanical / Electrical break down as defined in this warranty and confirmed by the dealer within the stipulated terms and conditions. TATA MOTORS dealer shall either rep air or replace any part found to be defective with a new p art or an equivalent at no cost to the owner for p arts or labour.

Such defective parts which have been replaced will become property of TATA MOTORS PASSENGER VEHICLES LIMITED.

Comprehensive list of parts covered is mentioned in the Extended Warranty Booklet.

### What is not Covered?

Please refer the Extended Warranty Booklet for details of the exclusion list. Soft copy of which will be provided by dealer.

### Owner's Responsibility

- Proper use, maintenance and care of the vehicle in accordance with the instructions contained in the Owner's Manual and Service Booklet. The records of the same to be ensured in Owner's Manual.
- Retention of maintenance service bills.

I / We have been explained the Terms and conditions, Coverage and Owner's responsibility by the Dealer Service Marketing Executive.

I wish to avail /  Do not wish to avail extended warrant policy.

**Customer's Signature**

**Dealer's Signature**

## VEHICLE CARE AND VALUE ADDED SERVICES

---

### VALUE ADDED SERVICES

**Why are Corrosion Protection Waxes necessary?**

**Corrosion is Caused by**

Water/salt water, acid rain and atmospheric fallouts.

**Critical Areas are**

Cavities: joints, crevices, spot welds, underbody

- Corrosion is the most important factor when we talk about the vehicle life. If you treat your car well, you can prolong its life.
- It is very dangerous to drive around in a corroded vehicle.
- Corrosion creeps onto the vehicle internally and externally as well. The most dangerous kind of corrosion is often not discovered until it is too late.

**Benefits of Anti - Rust Treatment**

- A professionally applied range of world class products offering real value to the new and used vehicle customer.
- The treatment has been developed to withstand the harshest environmental and climatic conditions (rust. Pollutants, stone and gravel impact, etc.)
- Insulates the cabin from external noises..
- Expensive tin work, denting and painting can be avoided.
- Higher resale value for the vehicle.
- Higher safety – uncorroded vehicle
- 10 free checkups available



---

TATA MOTORS has tied up with **M/s Wurth, M/s Autokrom, M/s 3M India Lt d & M/s Bardahl** for these world class treatment at af-



## **VEHICLE CARE AND VALUE ADDED SERVICES**

---

fordable prices. These treatments are available in all authorized workshops. The Dealer Service Marketing Executive will explain to you the benefits and terms and conditions of this treatment.

I / We have been explained the Benefits, Terms and conditions and the prices of these treatments by the Dealer Service Marketing Executive.

I wish to avail /  Do not wish to avail extended warrant policy.

**Customer's Signature**

**Dealer's Signature**

## VEHICLE CARE AND VALUE ADDED SERVICES

---

### VEHICLE EXTERIOR ENRICHMENT

#### Why Vehicles are Painted?

- For Corrosion protection of the metal surfaces.
- Ease of application from other corrosion protection treatments.
- Cheaper than other corrosion protection methods eg. Galvanizing, anodizing.
- For decoration and identification.

#### Various Environmental Hazards Affecting Paints

Environmental hazards: destroys your vehicle's finish.

Even as your new vehicle rolls off the assembly line, the paint is not protected.

#### The Enemy

Ultraviolet rays, pollution, tree sap, bird droppings, car wash chemicals, road salt and acid rain.

#### Benefits

Vehicle Exterior Enrichment

- Removal of medium scratches, orange peel, oxidation, dust nibs etc. & swirl marks from painted surface.
- Restoration of original gloss levels, UV protection after gloss is restored.
- Cleaning & dressing of tyres, Bumpers and all exterior plastic moldings/trims.

TATA MOTORS has tied up with **M/s Autokrom**, **M/s 3M** & **M/s Wurth** for this world class treatment at affordable prices.

This treatment is available in all authorized workshops. The Dealer Service Marketing Executive will explain to you the benefits and terms and conditions of this treatment.



### VEHICLE INTERIOR ENRICHMENT

#### Why Protect Your New Car's Fabric Interior

- Someone may soil your vehicle's fabric carpet or seats.
- A significant detractor from your vehicle's resale value.
- A permanent stain on your vehicle's interior fabric.

#### The Enemy

Drink spills, food stains, mud, ultraviolet rays, traffic and pets

Benefits: Vehicle Interior Enrichment

- Removal of medium stains and dirt from all interior parts of the car i.e., carpet, upholstery and roof lining.
- Cleaning of windshield and all windows (inner and outer surfaces)
- Dressing of all internal plastics (e.g.: door pad trims) and rubber parts.
- The treatment involves cleaning and dressing of all parts of the exposed interiors.
- Specialised protection for seat fabric from liquid spills.

TATA MOTORS has tied up with **M/s Wurth and M/s Autokrom** for this world class treatment at affordable prices. This treatment is available in all authorized workshops. The Dealer Service Marketing Executive will explain to you the benefits and terms and conditions of this treatment.

I / We have been explained the Terms and conditions, Coverage and Owner's responsibility by the Dealer Service Marketing Executive.

I wish to avail /  Do not wish to avail Extended warrant policy.

**Customer's Signature**

**Dealer's Signature**



---

## WARRANTY -TERMS AND CONDITIONS

### WARRANTY - TERMS AND CONDITIONS

We WARRANT each TATA ALTROZ vehicle and parts thereof manufactured by us to be free from defect in material and workmanship subject to the following terms and conditions:

1. This warranty shall be for a period of **2 years from the date of sale of the car or a mileage of 75,000 Kms whichever occurs earlier.**
2. Our obligation under this warranty shall be limited to re-pairing or replacing, free of charge, such parts of the car which, in our opinion, are defective, on the car being brought to us or to our dealers within the period. The parts so repaired or replaced shall also be warranted for quality and workmanship but such warranty shall be co-terminus with this original warranty.
3. Any part which is found to be defective and is replaced by us under the warranty shall be our property.
4. As for such parts as Tyres, Batteries, Audio and / or Video equipment (if any), etc. not manufactured by us but supplied by other parties, this warranty shall not apply, but buyers of the car shall be entitled to, so far as permissible by law, all such rights as we may have against such parties under their warranties in respect of such parts.
5. This warranty shall not apply if the car or any part thereof is repaired or altered otherwise than in accordance with our standard repair procedure or by any person other than from our sales or service establishments, our authorized dealers, service centres or service points in any way so as, in our judgment which shall be final and binding, to affect its reliability, nor shall it apply if, in our opinion which shall be final and binding, the car is subjected to misuse, negligence, improper or inadequate maintenance or accident or loading in excess of such carrying capacity as certified by us, or such services as prescribed in our Owner's Manual are not carried out by the buyer through our sales or service establishments, our authorized dealers, service centres or service points.
6. **This warranty shall not apply to the replacement of normal wear parts, including without limitation, spark plugs, drive belts, hoses, wiper blades, fuses, clutch disc, brake shoes, brake pads, cables and all rubber parts (except oil seal and glass run).**
7. This warranty shall not cover any inherent normal deterioration of the car or any of its parts arising from the actual use of the car or any damage due to negligent or improper operation or storage of the car.
8. This warranty shall not apply to normal maintenance services like oils & fluid changes, head lamps focusing, fastener retightening, wheel balancing and alignment, tyre rotation, adjustment of valve clearance, fuel timing, ignition timing and consumables like bulbs, fuel, air & oil filters and gas leaks in case of air conditioned cars.
9. This warranty shall not apply to any damage or deterioration caused by environmental pollution or bird droppings. Slight ir-

## WARRANTY -TERMS AND CONDITIONS

---

regularities not recognized as affecting the function or quality of the vehicle or parts, such as slight noise or vibration, defects appearing only under particular or irregular operations are items considered characteristics of the vehicle.

10. This warranty shall be null and void if the car is subjected to abnormal use such as rallying, racing or participation in any other competitive sport. This warranty shall not apply to any repair or replacements as a result of accident or collision.
11. This warranty is expressly in lieu of all warranties, whether by law or otherwise, expressed or implied, and all other obligations or liabilities on our part and we neither assume, nor authorize any person to assume on our behalf, any other liability arising from the sale of the car or any agreement in relation thereto.
12. The buyer shall have no other rights except those set out above and have, in particular, no right to repudiate the sale, or any agreement or to claim any reduction in the purchase price of the car, or to demand any damages or compensation for losses, incidental or indirect, or inconvenience or consequential damages, loss of car, or loss of time, or otherwise, incurred or accrued.
13. Any claim arising from this warranty shall be recognized only if it is notified in writing to us or to our authorized dealer without any delay soon after such defects as covered & ascertained under this warranty.

### **14. This warranty is fully transferable to subsequent vehicle**

**owner. Only unexpired remaining period of warranty applies.**

15. We reserve our rights to make any change or modification in design of the car or its parts or to introduce any improvement therein or to incorporate in the car any additional part or accessory at any time without incurring any obligation to incorporate the same in the cars previously sold

**ENVIRONMENT SAFETY**

TATA MOTORS PASSENGER VEHICLE LIMITED. is committed to produce vehicles using environmentally sustainable technology. A number of features have been incorporated in TATA MOTORS passenger vehicles which have been designed to ensure environmental compatibility throughout the life cycle of the vehicle. We would like to inform you that your vehicle meets BS VI emission norms and this is being regularly validated at the manufacturing stages. As a user you too can protect the environment by operating your vehicle in a proactive manner. A lot depends on your driving style and the way you maintain your vehicle. We have given a few tips for your guidance.

**Driving**

- Avoid frequent and violent acceleration.
- Do not carry any unnecessary weight in the vehicle as it overloads the engine. Avoid using devices requiring high power consumption during slow city traffic condition.
- Monitor the vehicle's fuel consumption regularly and if showing rising trend get the vehicle immediately attended at the Company's Authorised Service Outlets.
- Switch off the engine during long stops at traffic jams or signals. If you need to keep the engine running, avoid unnecessary revving it or stopping and starting.
- It is not necessary to rev the engine before turning it off as it unnecessarily burns fuel.

- Shift to higher gears as soon as it is possible. Use each gear upto 2/3rd of its maximum engine speed.
- A chart indicating gear shifting speeds is given in this book.

**Maintenance**

- Ensure that recommended maintenance is carried out on the vehicle regularly at the Authorised Service Outlets.
- As soon as you see any leakages of oil or fuel in the vehicle we recommend to get it attended immediately. Use only recommended grades and specified quantity of lubricants.
- Get your vehicle checked for emission periodically by an authorised dealer.
- Check Air filter, fuel filter and oil filter periodically and replaced, if required, as recommended by TATA MOTORS.
- Do not pour used oils or coolants into the sewage drains, garden soil or open streams. Dispose the used filters and batteries in compliance with the current legislation.
- Do not allow unauthorized person to tamper with engine settings or to carry modifications on the vehicle. Never allow the vehicle to run out of fuel.
- Parts like brake liners, clutch discs should be vacuum cleaned. Do not use compressed air for cleaning these parts, which may spread hazardous dust in the atmosphere.

## ENVIRONMENT SAFETY

---

### EMISSION AFFECTED COMPONENTS

While carrying out servicing or repairs of your vehicle, you should pay keen attention to some of the important engine aggregates and wiring harnesses, which greatly affect emission. These components are:

#### For Diesel

1. Fuel injection equipment- pump, rail, injectors, nozzles and high-pressure pipes.
2. Air Intake & Exhaust system, especially for leakages.
3. Cylinder head for valve leakage.
4. All filters such as air, oil and fuel filters (check periodically).
5. Turbocharger.
6. EGR Valve & Cooler
7. Intake throttle
8. Electrical connections.
9. If the 'Check Engine lamp', 'MIL' or 'DPF' lamp continuously glows, please take the vehicle to a TATA MOTORS Authorized Dealer/Service Center.
10. Catalytic Converter.(LNT - Lean NOx trap & DPF for Diesel)
11. EMS wiring harness i.e. electrical connections to all sensors and actuators.

#### For Petrol

1. Engine Management System (EMS)
  - ECU
  - EMS sensors & Corresponding wiring harness
  - Electrical connections to all sensors & actuators
2. Fuel Injection System
  - Fuel Pump
  - Fuel filter
  - Fuel Injectors
3. Air intake System
  - Air filter & connecting pipes
4. Exhaust after Treatment System
  - Catalytic Converter
5. Ignition System
  - Ignition coil
  - Spark plug

This Owner's manual contains further information on driving precautions and maintenance care leading to environment protection. Please familiarize yourself with these aspects before driving.



Customer's copy

Dealer's copy



**PDI Coupon**  
**ALTROZ**

Pre Delivery Inspection



**PDI Coupon**

**ALTROZ**

Pre Delivery Inspection

**AVAIL ALL SERVICES TO GET BENEFIT OF WARRANTY**

Owner's Name:

VIN No.:

Engine No.:

Reg. No.:

ODO Reading:

Date of Service:

**This Coupon entitles for free labour jobs.(Refer maintenance section)**

Owner's Name:

VIN No.:

Engine No.:

Reg. No.:

Date of Sale:

Service Dealer code:

ODO Reading:

Date of Service:

**I hereby certify that the PDI has been carried out to my entire satisfaction.**

Service Dealer's Stamp & Signature

Customer's Signature

Service Dealer's Stamp & Signature

(Free Service coupons are valid at all TATA Authorized Service Centers in India)



Customer's copy



Valid for 1000 - 2000 kms. OR 2 months,  
whichever is earlier

Owner's Name:

VIN No.:

Engine No.:

Reg. No.:

ODO Reading:

Date of Service:

Service Dealer's Stamp & Signature

Dealer's copy



**1<sup>ST</sup> Free Service Coupon**

**ALTROZ**

Valid for 1000 - 2000 kms. OR 2 months, whichever is earlier.

**AVAIL ALL SERVICES TO GET BENEFIT OF WARRANTY**

**This Coupon entitles for free labour jobs.(Refer maintenance section)**

Owner's Name:

VIN No.:

Engine No.:

Reg. No.:

Date of Sale:

Service Dealer code:

ODO Reading:

Date of Service:

**I hereby certify that the service has been carried out to my entire satisfaction.**

Customer's Signature

Service Dealer's Stamp & Signature

(Free Service coupons are valid at all TATA Authorized Service Centers in India)



Customer's copy



Valid for 7000 - 8000 kms. OR 6 months,  
whichever is earlier

Owner's Name:

VIN No.:

Engine No.:

Reg. No.:

ODO Reading:

Date of Service:

Service Dealer's Stamp & Signature

Dealer's copy



**2<sup>nd</sup> Free Service Coupon**

**ALTROZ**

Valid for 7000 - 8000 kms. OR 6 months, whichever is earlier.

**AVAIL ALL SERVICES TO GET BENEFIT OF WARRANTY**

**This Coupon entitles for free labour jobs.(Refer maintenance section)**

Owner's Name:

VIN No.:

Engine No.:

Reg. No.:

Date of Sale:

Service Dealer code:

ODO Reading:

Date of Service:

**I hereby certify that the service has been carried out to my entire satisfaction.**

Customer's Signature

Service Dealer's Stamp & Signature

(Free Service coupons are valid at all TATA Authorized Service Centers in India)



Customer's copy



Valid for 14,500 – 15,500 kms. OR 12 months,  
whichever is earlier

---

Owner's Name:

VIN No.:

Engine No.:

Reg. No.:

ODO Reading:

Date of Service:

Service Dealer's Stamp & Signature

Dealer's copy



**3<sup>rd</sup> Free Service Coupon**

**ALTROZ**

Valid for 14,500 – 15,500 kms. OR 12 months, whichever is earlier.

**AVAIL ALL SERVICES TO GET BENEFIT OF WARRANTY**

---

**This Coupon entitles for free labour jobs.(Refer maintenance section)**

Owner's Name:

VIN No.:

Engine No.:

Reg. No.:

Date of Sale:

Service Dealer code:

ODO Reading:

Date of Service:

**I hereby certify that the service has been carried out to my entire satisfaction.**

Customer's Signature

Service Dealer's Stamp & Signature

(Free Service coupons are valid at all TATA Authorized Service Centers in India)

