

TATA MOTORS
Connecting Aspirations



OWNER'S MANUAL

www.tatanexon.com

ALL NEW
NEXON



NEXON

OWNER'S MANUAL



TATA MOTORS

CUSTOMER ASSISTANCE

In our constant endeavour to provide assistance and complete service backup, TATA MOTORS has established an all India customer assistance centre.

In case you have a query regarding any aspect of your vehicle, our Customer Assistance Centre will be glad to assist you on our Toll Free no. **1800 209 7979**

You can also approach nearest TATA MOTORS dealer. A separate Dealer network address booklet is provided with the Owner's manual.

TATA MOTORS' 24X7 Roadside Assistance Program offers technical help in the event of a breakdown. Call the toll-free roadside assistance helpline number.

For additional information, refer to "**24X7 Roadside Assistance**" section in the Owner's manual.



Dear Customer,

Welcome to the TATA MOTORS family.

We congratulate you on the purchase of your new vehicle and we are privileged to have you as our valued customer.

We urge you to read this Owner's Manual carefully and familiarize yourself with the equipment descriptions and operating instructions before driving.

Always carry out prescribed service/maintenance work as well as any required repairs at an authorized TATA MOTORS Dealers or Authorized Service Centre's (TASCs). Use only genuine parts for continued reliability, safety and performance of your vehicle.

You are welcome to contact our dealer or Customer Assistance toll free no. **(1800 209 7979)** in case of any query or support required.

We wish you a safe and pleasant driving experience.

TATA MOTORS

Bombay House, 24, Homi Modi Street,
Hutatma Chowk, Fort, Mumbai – 400001

IMPORTANT INFORMATION

- Before driving, read this owner's manual carefully and familiarize yourself with your vehicle. For your own safety and a longer vehicle life, follow the instructions, 'Warnings' and 'Notes' in this manual. Ignoring them could result in damage to the vehicle or personal injury to you or others.
- The owner's manual and other booklets are important documents and should always be kept in the vehicle. If you sell the vehicle, always pass on the documents to the new owner.
- This owner's manual describes all variants of the model and all standard/optional equipment of your vehicle available at the time of printing. Please note that your vehicle may not be equipped with all features described.
- TATA MOTORS Limited reserves the right to introduce changes in the design, equipment and technical features without any obligation to install them on the vehicles previously sold. The equipment in your vehicle may therefore differ from that shown in the descriptions and illustrations.
- Do not carry out any modification including fitment of non-genuine accessories on your vehicle. Safety, handling, performance and durability, may otherwise be adversely affected and may violate government regulations. TATA MOTORS Limited accepts no liability for damage resulting from the modifications or use of non-genuine accessories.
- All rights reserved. The information in this manual shall not be copied, translated or otherwise reproduced, in whole or in part, without written permission from TATA MOTORS.

© Copyright 2020 TATA MOTORS

CONTENTS

1	Safety	2	Opening & Closing	3	Dashboard & Features
Important Information	01	Keys	23	Cockpit	45
Safe Driving	01	Doors	31	Instrument Cluster	46
Seat Belts	04	Windows	32	Driver Information System	51
Child Restraint System (CRS)	08	Opening the bonnet	34	Tell Tales	67
SRS -Airbags	12	Tail gate opening	36	Audio Reminders	76
Child Lock	18	Fuel lid	38	Combi Switches	77
Anti-theft Device: Immobilizer	19	Power Sunroof	40	Dashboard controls	81
ABS	20			Steering mounted control	82
EBD	20			Mic	84
Additional safety features	21			Infotainment System Display	84

CONTENTS

3 Dashboard & Features

Speakers & Tweeter 85

USB 85

Power Socket 85

Antenna 86

Roof Grab Handles 87

Roof Lamp 87

Boot Lamp 87

Front Lamp 88

Tail Lamp 88

4 Stowage Areas

Storage Compartments 89

Glove Box 90

Wallet stowage 91

Driver side coin box 91

Utility pockets on front doors 91

Utility pockets on rear doors 92

Center Console 92

Stowage for rear passenger 93

Foldable arm rest 93

Tailgate compartment 94

Hooks 94

5 Climate Control

Air Distribution 97

Air Vents 98

Rear AC Vents 98

HVAC Controls 99

Functions & Settings 102

Fully Automatic temperature
Control - FATC 103

FATC sensors 106

Xpress cooling 107

Functions & Settings 108

6	Starting & Driving	6	Starting & Driving	7	Emergency & Break-down Assistance
Pre-Driving Checks	109	Gear Shifting and Driving	125	Emergency Equipment	153
Driving Tips	110	Automated Manual Transmission (AMT)	127	Hazard Warning Switch	154
Seat Adjustments	113	Starting and stopping (PEPS)	133	In Case of Flat Tyre	156
Rear View Mirrors	118	PEPS – Wearable key	135	Jump starting your car	159
ORVM folding	120	Drive mode	141	Towing	161
Sun Visors	121	Parking Brake	142	Fuses	163
EPAS	121	Vehicle parking	142	Bulb Specification	169
Steering wheels adjustment	122	Reverse Park Assist	143	24x7 Road Side Assistance	170
Steering lock and ignition switch	123	Rear View Camera	146		
Starting and stopping (without PEPS)	124				

CONTENTS

8	Maintenance		9	Technical Information		10	Car Care and Value Added Services
Maintenance & Service	173	Fuel Specification	195	Car Care	203		
Engine Compartment	174	Lubricant Specification	196	Washing	203		
Engine Oil	176	Technical Specification	197	Waxing	204		
Battery	180	Vehicle Dimensions	200	Polishing	204		
Spark Plug	182	Aggregate Identification Nos	201	Interior Fabric Cleaning	204		
Tyres	182			Paint Care	205		
Smart key Battery replacement	185			Value care - AMC	206		
Wearable key battery replacement	185			Extended warranty	210		
On Board Diagnostic (OBD)	186			Value Added Services	212		
Service Schedule	187						
Parking for Long Durations	194						

11

**Warranty – Terms and
Conditions**

Warranty –
Terms & Conditions 217

12

Environment Safety

Environment Safety 219

CONTENTS

Important Information

In this Owner's Manual, you will find the text under the heading "WARNING" and "NOTE" which highlights important information. Pay particular attention to these highlighted messages.

NOTE

Indicates additional information that will assist you in gaining the optimum benefit and care for your vehicle.

WARNING

Indicates procedures or information that must be followed precisely in order to avoid the possibility of severe personal injury and serious damage to the vehicle.

Safe Driving

Safety consciousness not only ensures your safety and the safety of other road users, but it also helps to reduce the wear and tear on your vehicle.

Safe driving depends on:

- How quickly you make decisions to avoid an accident.
- Your ability to concentrate.
- How well you can see and judge objects.
- How well familiar you are with your vehicle controls and its capabilities.

NOTE

Fatigue is a result of physical or mental exertion that impairs judgment. Driver fatigue may be due to inadequate sleep, extended work hours, strenuous work or non-work activities or combination of other factors. Take rest at regular intervals.

Safety Tips

- Always take into account the road conditions, weather conditions, vehicle speed in order to prevent accidents.
- Turn 'ON' the side indicators at least 30 meters before taking a turn or changing the lane.
- Decelerate to a safe speed before taking turn. Do not apply brakes during cornering.
- When overtaking other vehicles, watch out for the oncoming vehicle.
- Never drive under the influence of alcohol or drugs.
- If your vehicle is equipped with infotainment/navigation system, set and make changes to your travel route only when the vehicle is parked.
- Program radio presets with the vehicle parked, and use your programmed presets to make radio use quicker and simpler.

SAFETY

Driving through water

Do not drive through flooded areas. Judge the depth of water before driving through it. Otherwise, water may enter the vehicle interior or the engine compartment.

If at all the situation demands that you have to drive through water then;

- Keep engine in higher RPM and crawl the vehicle in low gear.
- Flowing or rushing water creates strong forces. Driving through flowing water could cause the vehicle to about trying to drive through flowing water.
- Lightly apply the brake pedal to dry the liners until the brakes work normally once you are out of water.

WARNING

Do not attempt to start the engine if vehicle gets flooded due to water. Tow the vehicle to a safe place. Contact a nearest TATA MOTORS Authorised Service Centre

Driving on a rainy day

- Check wiper blades, lights and brakes for proper functioning and condition.
- Check the tyre treads depth, the condition of the tread and tyre.
- Avoid harsh braking and sharp turns. It may cause loss of control and lead to a skid.
- For slowing down, shift to lower gears and brake gently.
- Keep lights 'ON' if visibility is poor.

Driving on wet roads

On wet road or during light showers, "Aquaplaning" can occur. "Aquaplaning" is the loss of direct contact between the road surface and the vehicle's tires due to a water film forming between them. Steering or braking the vehicle can be very difficult, and loss of control can occur.

There is no hard and fast rule about aquaplaning. The best advice is to slow down when the road is wet.

NOTE

If you have driven for a long time in heavy rain without braking, there may be a delayed reaction from the brakes when braking for the first time. You have to press the brake pedal more firmly. Maintain a greater distance from the vehicle in front.

Night driving

- Ensure that all lights are working and windshield, window glasses are clean.
- Drive more slowly at night than in the daytime, as the visual range is restricted at night. Maintain a speed such that you can stop within illuminated distance of headlamps.
- Do not use the high beam unless inevitable. It may dazzle the driver of the oncoming vehicle, thus causing an accident.
- Use headlamp main/dip beam to alert other road users on turns/cross roads etc.
- Use side indicators for lane change or turning.

Driving on gradients

When climbing gradient, the vehicle may begin to slow down and show a lack of power. If this happens, shift to a lower gear and apply power smoothly so that there is no loss of traction.

When driving down a hill, the engine braking should be used by shifting into a lower gear. Do not drive in neutral gear or switch off the engine.

WARNING

On long and steep gradients you must reduce the load on the brakes by shifting early to a lower gear. This allows you to take advantage of the engine braking effect and helps avoid overheating of service brakes resulting in reduced braking efficiency.

Driving on highway

Stopping distance progressively, increases with vehicle speed. Maintain a sufficient distance between your vehicle and the vehicle ahead.

For long distance driving, perform safety checks before starting a trip and take rest at certain intervals to prevent fatigue.

SAFETY

Seat Belts

This section of user manual describes your Vehicle's seat belt, airbag and Child restraints system. Please read and follow all these instructions carefully to minimise risk of severe injury or death.

- Seat belts are the primary restraints system in the vehicle. All occupants, including the driver, should always wear their seat belts to minimize the risk of injury.
- Sit back and adjust (if equipped), the seat. Make sure that your seat is adjusted to a good driving position and the back of the seat is upright.

Buckling the shoulder seat belt

- Grasp the tongue then slowly pull out the seat belt over the shoulder and across the chest. When the seat belt is long enough to fit, insert the tongue into the lock buckle until you hear a "CLICK" which indicates that the seat belt is securely locked.
- Position the lap portion of seat belt across your pelvic bone (hips), below your abdomen. To remove slack, pull up a bit on the shoulder seat belt. To loosen the lap portion seat belt if it is too tight, tilt the tongue and pull on the lap seat belt. A snug seat belt reduces the risk of sliding under the seat belt in a collision. Ensure that the seat belt running over the body (shoulder segment and lap segment) does not have any twist. Twisted seat belt may not offer effective protection when required.

Releasing the seat belt

To release the seat belt, push the red button on the lock buckle. The seat belt will automatically retract to its stowed

position. If necessary, slide the tongue down the webbing to allow the seat belt to retract fully.

Fixed rear centre lap seat belt

- When buckling, make sure you hear a click confirming that the tab is latched into the seat belt lock. To tighten it, pull the loose end through the buckle until the seat belt is comfortably adjusted around the pelvic bone (hips).



NOTE

The above image is for reference purpose only.

Seat belt height adjustments (If applicable)

If height adjustment is provided in the seat belt, occupant can adjust it to their comfort, as may be applicable.

**NOTE**

The above image is for reference purpose only.

WARNING

- Each seating position and seat belt assembly must be used by one occupant. It is not recommended to put a seat belt around a child, being carried on an occupant's lap.
- Be careful not to damage or tamper the seat belt webbing or hardware. Inspect the seat belt system periodically, checking for cuts, frays, or loose parts. A frayed or torn seat belt could rip apart in a collision and leave you with no protection.
- If the seat belt webbing or hardware is damaged, get it replaced immediately at TATA Motors Authorized service centre.
- Do not insert any items such as coins, clips, etc. into the seat belt buckles, and be careful not to spill liquids into these parts. If foreign materials get into a seat

belt buckle, the seat belt will not work properly.

- Do not wear seat belts over hard, sharp or fragile items in clothing, such as pens, keys, spectacles etc.
- Do not use any accessories on seat belts or modify in any way the seat belt system. Devices claiming to improve occupant comfort or repositioning the seat belt, can reduce the protection provided by the seat belt and increase the chance of serious injury in a collision.

SAFETY

Seat Belts with Pre – tensioner

(If equipped)

You can use pre-tensioner seat belts in the same manner as ordinary seat belts.

The seat belt pre-tensioner system works in conjunction with the SUPPLEMENTARY RESTRAINTS SYSTEM (SRS-Airbags).

In the event of a collision, as may be necessary, pre-tensioner tightens the seat belt so that it fits the occupant's body more snugly. When pre-tensioner activates, there could be some noise and release of smoke. This is normal and there are no health hazards or fire risk.

WARNING

In a collision, the pre-tensioner seat belt assembly mechanisms becomes hot during activation. Do not touch the pre-tensioner seat belt assemblies for several minutes after they have been activated.

If the vehicle has been involved in a collision, get it inspected immediately at authorised TATA MOTORS SERVICE Center.

Seat Belt with Load Limiter

(If equipped)

You can use the load limiter seat belts in the same manner as ordinary seat belts. The seat belt load limiter system works in conjunction with the SUPPLEMENTARY RESTRAINTS SYSTEM (SRS-Airbags).

In the event of a collision, as may be necessary, load limiter reduces the load on the rib cage region of the occupant.

If the vehicle has been involved in a collision, get it inspected immediately at Authorised TATA MOTORS SERVICE Center.

Use of seat belts for pregnant woman

WARNING

- Pregnant woman must wear a correctly positioned seat belt. It is safer for mother as well as unborn child.
- Pregnant woman should wear the lap part of the seat belt across the pelvic bone (hips) and as snug across the hips as possible. Keep the seat belt low so that it does not come across the abdomen. That way the strong bones of the hips will take the force if there is a collision.

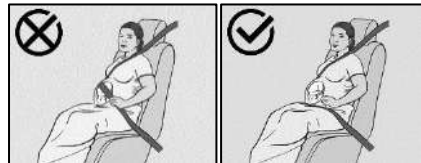

Seat belt warning lamp



For Driver



For Front
Passenger

The seat belt warning lamp reminds you to fasten the seat belt.

- If the driver does not fasten seat belt, seat belt reminder lamp will blink and a buzzer will sound for pre-defined duration until the driver's seat belt is buckled.
- If front passenger seat is occupied by adult and does not fasten seat belt, seat belt reminder lamp will blink and a buzzer will sound for pre-defined duration until the front passenger seat belt is buckled.
- If this system is also provided for other than Front row seats, applicable above warnings will appear until seat belts are buckled.
- If front passenger seat is occupied by child, system may detect occupancy

and warn with front passenger seat belt warning. It is not taken to mean child can occupy front passenger seat and use seat belt. Please refer CRS section for recommended seating position.

NOTE

"Using unauthorized after-market seat cover may affect function of occupant sensor. TATA MOTORS does not recommended any non-validated seat covers on seats."

SAFETY

Child Restraint System (CRS)

TATA MOTORS strongly recommends the use of Child Restraint Systems (CRS) for all children up to age of 12 years and to be placed at recommended positions only. Children travelling without recommended CRS and seated at other positions may face serious injuries in case of a collision.

CRS can be installed in the vehicle using seat belts and/or ISOFIX only (if equipped) or ISOFIX with Top Tether (if equipped).

The harness system of CRS holds the child in place, and in a collision, acts to keep the child positioned in the seat and reduce the risk of injuries.

All children below age of one year must always ride in a rear-facing infant CRS.

Keep children above age of one year, in a forward-facing CRS with a harness until they reach the size or weight limit allowed by your CRS manufacturer.

Once your child outgrows the forward-facing CRS, your child is ready for a booster seat.

Selection and installation of CRS:

Always select the CRS that complies with latest safety standards (AIS072 / ECE R44). The CRS are classified according to the child's size, height and weight. Select the appropriate CRS for your child. Ensure that the CRS is securely installed in the vehicle and subsequently child fits properly in it and wears harness of CRS. For installation, please refer CRS manufacturer's instruction manual.

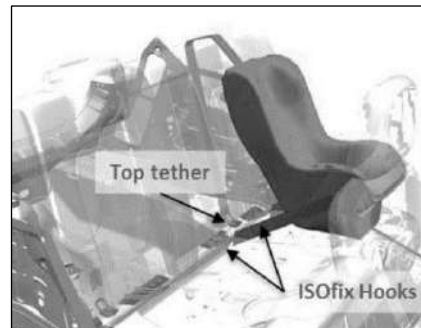

NOTE

The above images are for reference purpose only.

Recommended CRS position as per the vehicle matrix

The suitability of seat position for carriage of children and recommended category of CRS is shown in the table below as per the child group.

X - Seat Position not suitable for children in this age group.

U - Suitable for “universal” category restraints approved for use in this age group.

Universal is a category in the AIS072 / ECE R44 norm.

Group	Mass Group	Age Group	Front Passenger	Rear Outboard LH	Rear Outboard RH	Rear Center
0	Up to 10 kg	Up to 9 months	X	U	U	X
0+	Up to 13 kg	Up to 24 months	X	U	U	X
I	9 to 18 kg	9 months to 48 months	X	U	U	X
II	15 to 25 kg	Approx. 3 to 7 Years	X	U	U	X
III	22 to 36 kg	Approx. 6 to 12 Years	X	U	U	X

WARNING

If a child is seated in the front seat it may cause serious injury or even death during any collision.

SAFETY

WARNING

If your vehicle is equipped with a front passenger Airbag (PAB) and does not have PAB deactivation switch, do not install a rear-facing CRS in the front passenger seat. If the PAB inflates, a child in a rear facing CRS could be seriously injured or killed.

If you install a CRS in the rear seat, slide the front seat far enough forward so that the child's feet do not touch the front seatback. This will help avoid injury to the child in the event of a collision.

NOTE

Children could be endangered in a collision if their CRS is not properly secured in the vehicle. Be sure to secure the child in the restraint system according to the manufacturer's instructions.

WARNING

Do not use an infant carrier or a child safety seat that "hooks" over a seatback, it will not provide adequate protection in a collision.

After a collision, we recommend to get seat belts, seats, ISOFIX and top-tether anchorages (as may be applicable) investigated at TATA MOTORS Authorised service centre.

NOTE

A CRS in a closed vehicle can become very hot. To prevent burns, check the seating surface and buckles before placing your child in CRS.

WARNING

- Do not leave unattended children in your vehicle.
- Do not modify CRS in any way.

NOTE

- *Do not install a booster seat or a booster cushion with only the lap strap of the seat belt.*
- *Do not install a booster seat or a booster cushion with a seat belt that is slack or twisted.*
- *Do not put the safety seat belt under your child's arm or behind its back.*
- *Do not use pillows, books or towels to boost your child's height.*
- *Make sure that your children sit in an upright position.*
- *Do not allow children to stand up or kneel on either the rear or the front seats. An unrestrained child could suffer serious or fatal injuries during a collision.*
- *Do not leave any toys or other objects loose in the CRS or on the seat while the vehicle is in motion.*

Each CRS should be used for one child only.

When PAB deactivation switch (if provided) is turned 'OFF', make sure 'PAB' operational status lamp illuminates with ignition 'ON', indicating that the passenger airbag is NOT operational. If the airbag SRS warning indicator in the instrument cluster illuminates continuously, it means that there is malfunction in the system. Remove the CRS from front passenger seat and contact your TATA MOTORS authorised service center.

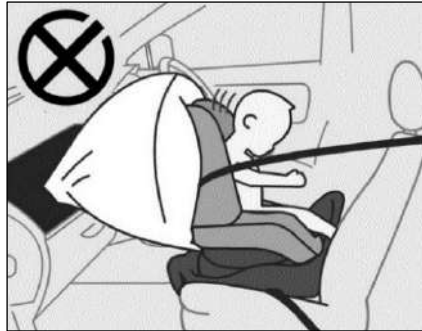
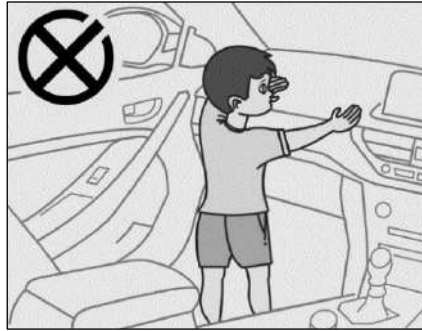
**NOTE**

The above image's are for reference purpose only.

SAFETY

Supplementary Restraint System (SRS - Airbags) (If equipped)

The airbag 'SRS' system comprises of the following components depending upon the provided safety features in your vehicle.

- Seat belt Pre-tensioners
- Seat belt with load limiters
- Driver Airbag
- Front Passenger Airbag
- Airbag 'SRS' ECU (Electronic Control Unit)
- Collision Sensors
- SRS wiring harness
- SRS Warning lamp

The System is active when ignition switch is in the "ON" position or the ignition mode is "ON". Airbags are designed to inflate in severe collisions. In the event of a collision, the collision sensors will detect signals, and if the Airbag ECU judges that the signals represent a severe collision, will trigger

the airbags. The inflated Airbags provide a cushion to the occupants. The Airbag inflates and deflates so quickly that you may not even realize that it has activated. The Airbag will neither hinder your view nor make it harder to exit the vehicle.

Airbag inflation is virtually instantaneous and occurs with considerable force, accompanied by loud noise and smoke, which is normal. The inflated airbag, together with seat belts, limit the movement of an occupant, thereby reducing the risk of injury.

When an airbag inflates, you may see some smoke-like particles. The particles are a normal by-product of the process that generates the non-toxic gas used for airbag inflation. These airborne particles may irritate the skin, eyes, nose, or throat. If you have skin or eye irritation, rinse the area with water. For nose or throat irritation, move to fresh air. Also sometimes the smoke can cause breathing problems, in such cases, it is recommended to get fresh air promptly.

After inflation, airbag provides a gradual cushioning effect for the occupant thereafter deflates. It is not advisable to drive your vehicle after the airbags have been deployed. If you are involved in another collision, the airbags will not be in place to protect you.



NOTE

The above image is for reference purpose only.

NOTE

- *Open your windows and doors as soon as possible after collision to reduce prolonged exposure to the smoke and powder released by the inflating Airbag.*
- *Do not touch the Airbag container's internal components immediately after an Airbag has inflated. The parts that come into contact with an inflating Airbag may be very hot.*
- *Always wash exposed skin areas thoroughly with lukewarm water and mild soap.*

The driver airbag is mounted in the centre of the steering wheel. The front passenger airbag is located inside the dashboard in front of the passenger seat. The vehicle fitted with the airbags have suitable indications on steering wheel and on dash board. The word 'AIRBAG' is embossed on the airbag covers.

WARNING

- Even in vehicles with Airbags, you and your passengers must always wear the seat belts provided. In order to minimize the risk and severity of injury in the event of a collision.
- ALWAYS use seat belts and CRS – during every trip and at all times. Even with airbags, you can be seriously injured or killed in a collision if you are not wearing seat belt properly or not wearing seat belt when airbag inflates.
- You and your passengers should never sit or lean unnecessarily close to the Airbags.
- Move your seat as far back as possible from front Airbags, while still maintaining control of the vehicle.
- All occupants should sit upright with the seatback in an upright position, centred on the seat cushion with their seat belt on, legs comfortably extended and their feet on the floor until the vehicle is parked and the engine is turned off.

- If an occupant is out of position during collision, the rapidly deploying Airbag may forcefully contact the occupant causing serious or fatal injuries.
- Do not allow the front passenger to place their feet or legs on the dashboard.
- Do not allow the passenger to ride in the front seat when the front passenger Airbag OFF indicator is illuminated.

Not recommended seating position**NOTE**

The above image is for reference purpose only.

SAFETY

Not recommended seating position



NOTE

The above image's are for reference purpose only.

WARNING

- Never place your arm over the airbag as a deploying airbag can result in serious arm fractures or other injuries.
- Do not place or stick any item/s in the vehicle, except at designated locations (such as utility bins, cup/bottle holders, boot space etc). Loose items may act as a projectile during a collision and cause severe to fatal injuries.
- Please be aware that any unsecured item in your vehicle, such as your pet, unsecured CRS or a laptop, can become a potential hazard in the event of a collision or sudden stop, causing injuries to occupants in the vehicle.
- Coat hooks (if provided), must be used only for that purpose. Never hang other items on to those hooks. This could affect

deployment of the Airbags, and may lead to severe to fatal injuries.

- ALWAYS contact your TATA MOTORS authorised service centre if the vehicle is damaged, even if airbag has not inflated.
- ALWAYS contact your TATA MOTORS authorised service centre if any part of an airbag module cover shows sign of cracking or damage.

WARNING

If your SRS malfunctions, the Airbag may not inflate properly during a collision thereby increasing risk of serious injury or death. If any of the following conditions occur, your SRS is malfunctioning:

- The SRS warning lamp does not turn 'ON' when the ignition switch is placed in the 'ON' position for few seconds.
- The SRS warning lamp stays 'ON' after illuminating
- The SRS warning lamp comes 'ON'/stays 'ON' while the vehicle is in motion.
- The SRS warning lamp blinks when the engine is running.

We recommend the customer to immediately visit TATA MOTORS authorised service centre and get the SRS system inspected if any of the above conditions occur.

SAFETY

WARNING

- Never make any modifications to your vehicle. The modifications carried out, but not limited to the vehicle frame, bumpers, front fenders, ride height, suspension, seat belts, interior trims, steering wheel (especially holders), are not acceptable. This will affect the intended performance of SRS.
- Fitment of bull bars, seat covers on seats with airbags etc, is strictly prohibited, unless authorised by TATA MOTORS. This will affect the intended performance of SRS.
- If you need to make any modifications to accommodate any disability you may have, please contact your Authorized TATA MOTORS Dealer for necessary guidance.
- Do not tamper with SRS in any way. This will lead to unexpected

performance of system and may cause serious injury or death.

Airbag Warning sticker on front passenger Sun visor



The Airbag Warning Symbol on sun visor reminds extreme hazards associated with the use of rearward-facing child restraint on front passenger seat during airbag deployment.

It is not taken to mean child can occupy front passenger seat and use seat belt. Please refer CRS section for recommended seating position for children.

WARNING

Never use a rearward facing child restraint on a seat protected by an active Airbag in front of it, Death or serious injury to the child can occur.

Airbag Deployment Conditions

When front airbags (if equipped) should not deploy?

Minor frontal collision: Seat belt (if worn), offers adequate occupant protection in low severity collisions. The airbags are triggered only when there is a collision severe enough to trigger the airbags. Deployment of frontal airbags is not beneficial in low severity collisions.

Side collision: During a side collision, occupants tend to move sideways. Therefore, deploying frontal airbags in such situations will not benefit the occupants. Side airbags, and side curtain airbags (if equipped) are specifically designed to reduce the injuries that can occur in a side collision.

Rear collision: During a rear collision, occupants tend to move (rearwards) away from frontal airbags. Therefore, deploying frontal airbags in such situations

will not protect the occupants. Head restraints and seat belts provide occupant protection during a rear collision.

Rollovers collision: During a rollover collision, unbelted occupants may float inside the passenger compartment. This will increase the risk of injuries and may prove to be fatal. Wearing seat belts provide highly effective occupant protection during rollover collision. Front airbags, are not designed to deploy in a rollover as frontal airbags cannot offer any protection in rollover collision.

When front airbags deploy with minor or no visible vehicle damage?

The airbags are triggered only when there is a collision severe enough to trigger the airbags. The extent of vehicle damage is not always the correct indicator for airbag deployment. In some extreme/rare conditions; of rough road driving, running into a curb or hitting other fixed objects; the airbags may deploy depending upon the severity of col-

lision. In some of these conditions, damage to the vehicle may be minor or not be readily visible.

When front airbags may not deploy, even with exterior visible vehicle damage?

The airbags are triggered only when there is a collision severe enough to trigger the airbags. The amount of visible vehicle damage is not always the correct indicator for airbag deployment. Some collisions can result in visible damage but with no airbag deployment, because the airbags would not have been needed or would not have provided protection even if they had deployed. Seat belts, if worn, offer adequate occupant protection in such cases.

SAFETY

Child Lock (if equipped)

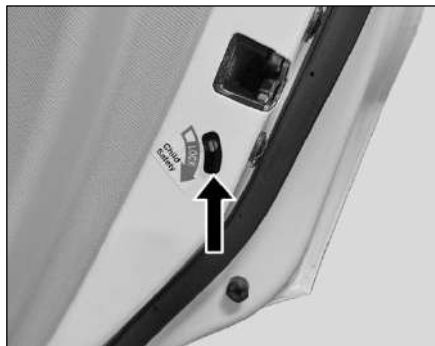

Both the rear doors of the vehicle are provided with a child proof lock. Push the lock lever located on vertical face of the door downward before closing the door. The door which has been closed by activating the child lock cannot be opened from inside, it can be opened only from the outside.

NOTE

- *Lift the lock lever upward to deactivate the childproof lock when not required.*
- *Child safety lever to be used for safety of child for preventing them to open rear door while seating in passenger seat to avoid accident while vehicle is running.*

Anti-Theft Device-Immobilizer/ PEPS (If equipped)

Immobilizer system is designed to prevent vehicle theft by electronically disabling the engine ignition system. The engine can be started only with vehicle's original Immobilizer ignition key which has an electronic identification programmed code.

NOTE

Use only Flip key, the other should be kept in a safe location. Note down "key Tag no." information (and keep it safe) which is required while getting new/spare keys. Re-member that it is not possible to prepare new/spare keys without the "key Tag number." Take pre-caution about Flip key, as without Flip key vehicle cannot be started.

Vehicle Condition	Immobilizer Lamp Status	Vehicle State	Meaning / Function of the state
Ignition OFF	Blinking	Locked	Vehicle Immobilized and awaiting electronic key
Ignition ON	OFF	Unlocked	Normal condition and ready to start the vehicle
Ignition ON	ON	Locked	<ul style="list-style-type: none"> - Problem with key (Wrong key used to start vehicle) - Problem with Immobilizer system. Contact a TATA MOTORS Authorized Service Centre
Ignition ON	Blinking	Unlocked	<ul style="list-style-type: none"> - Contact a TATA MOTORS Authorized Service Centre immediately

SAFETY

Anti-lock braking system (ABS)

(If equipped)



ABS regulates brake pressure in such a way that the wheels do not lock when you brake. This allows you to continue steering the vehicle when braking.

The ABS warning lamp in the instrument cluster lights up when the ignition is switched on. It goes off after 2-3 seconds if system is healthy.

WARNING

- If ABS is faulty, the wheels could lock when braking. The steering ability and braking characteristics may be severely impaired. There is an increased danger of skidding and accidents.
- Drive on carefully. Have ABS checked immediately at the TATA MOTORS Authorized Service Centre as soon as possible.

While Braking

- If ABS intervenes: continue to depress the brake pedal vigorously until the braking situation is over.
- To make a full brake application: depress the brake pedal with full force.

If ABS intervenes when braking, you will feel a pulsing in the brake pedal. The pulsating brake pedal can be an indication of hazardous road conditions, and functions as a reminder to take extra care while driving.

WARNING

- The stopping distance required for vehicles with ABS may be slightly more than conventional brake system but ABS will still offer the advantage of helping you maintain directional control.
- However, remember that ABS will not compensate for bad road or weather conditions or poor driver

judgment. Drive within safety margin taking into consideration prevailing weather and traffic conditions.

Electronic brake force distribution (EBD)

EBD monitors and controls the brake pressure on the rear wheels to improve driving stability while braking.



EBD provides optimal braking pressure distribution between front and rear wheels to optimize braking distance and to ensure vehicle stability by means of lowering braking pressure at rear wheels.

WARNING

- If EBD is malfunctioning, the rear wheels can lock, e.g. under full braking. This increases the risk of skidding and an accident.
- You should therefore adapt your driving style to the different handling characteristics. Have the brake system checked immediately at a TATA MOTORS Authorized Service Centre as soon as possible.

Electronic Stability Program (ESP) (if equipped)

ESP monitors driving stability and traction.



If ESP detects that the vehicle is deviating from the direction desired by the driver, one or more wheels are braked to stabilize the vehicle. The engine output is also modified to keep the vehicle on the desired course within physical limits. ESP assists the driver when pulling away on wet or slippery roads. ESP can also stabilize the vehicle during braking and acceleration.

Additional safety features (as available)

Cornering Stability Control (CSC)

Corner stability Control supports / stabilizes vehicle during partial braking on curves by reducing pressure at required inner wheel of the vehicle.

This helps to reduce probability of vehicle over steering during cornering.

OFF Road ABS

Based on wheel speed information off road ABS helps to avoid wheel lock on uneven surfaces like loose gravel, pot-holes by reducing the stopping distance compared to standard ABS.

Electronic Traction Control (ETC)

The Electronic Traction Control system function (ETC) is designed as a slip control system to prevent the driven wheels of a vehicle from excessive wheel slip.

Roll over Mitigation (ROM)

The main feature of the Roll over Mitigation function is the detection of a rollover critical situation and to prevent the vehicle rollover. This is done by active brake interventions on selected wheels, thereby reducing the forces that cause a rollover situation.

Brake Disc Wiping (BDW)

Water on the brake disc leads to a delay in brake response time. The purpose of the function Brake Disc wiping is to re-

SAFETY

move moisture when driving in wet conditions automatically. To get quick response from Brake and better deceleration.

Electronic Brake Pre-fill (EBP)

The Electronic Brake Prefill (EBP) function reduces the air gap of the brake pad and the brake disc. The function is triggered after a sudden release of the accelerator pedal due to an unexpected emergency brake situation. By actively pre-filling the brake-system, the brake response time is reduced and results in a shorter stopping distance.

Hydraulic Brake Assist (HBA)

In a dangerous emergency situation, most drivers don't use the full available performance of the brake system, because they brake too soft. The HBA function detects the critical situation and builds up additional brake pressure to reduce the braking distance.

Dynamic Wheel Torque by Brake (DWT-B)

The main goal of the function is to improve the agility of a vehicle and to enable a more direct steering. This is mainly achieved by braking interventions at the inner wheels during turning. DWT-B reduces understeer tendency of the car and a higher curve speed can be achieved.

Engine Drag Torque Control (EDTC)

On slippery road conditions during in-gear Braking or Shift down of gear or sudden throttle release on a curve road.

This causes high Engine drag on the driven wheel resulting into brake slip situations without any brake application.

This makes vehicle highly under steerable. EDTC controls such brake slip on the driven wheels by increasing the engine torque to makes the vehicle stable and steerable.

Hill Hold Control (HHC)

Hill Hold Control is a comfort function. The main intend is to prevent the vehicle from rolling backwards while driving off up-hill on an inclined surface.

KEYS

A key is an electronic access and authorization system available as a standard feature with your vehicle.

Unlocking principle

The transponder in the ignition key carries a Unique Identification Code (UID). The vehicle unlocks when the code on the key matches with the code on the Engine Management System (EMS). In case of PEPS variant, Immobilizer function is provided by PEPS ECU.

Engine starting

When the key is inserted and the ignition is switched to 'ON', all codes are communicated within key, Immobilizer and EMS. The engine will start only if all the codes match.

Loss of keys



If one of the keys is lost, Contact the TATA MOTORS Authorized Dealer/Service Center immediately.

WARNING

- Do not turn 'ON' ignition switch by using key with any type of metal wound around its grip or in contact with it. This may be detected as abnormal condition by immobilizer and prevent engine from starting.
- Do not leave the key in high temperature areas. The transponder in it will behave abnormally when reused.
- Do not try to start the vehicle when the Immobilizer indicator lamp on the instrument cluster is glowing. In this condition the vehicle will not start and the vehicle's battery will also be drained due to frequent cranking.

OPENING AND CLOSING

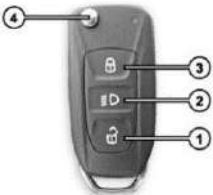
Keys (as available)

SN	Name	Remote key	Description
1.	Mechanical key		<ol style="list-style-type: none">1. Locking all doors2. Unlocking all doors
2.	Flip key with remote		<ol style="list-style-type: none">1. Unlocking all doors2. Approach light/Tail gate opening3. Locking all doors4. Folding key blade in/out
3.	Smart Key (PEPS)		<ol style="list-style-type: none">1. Locking all doors2. Approach light3. Tail gate opening4. Unlocking all doors

OPENING AND CLOSING

SN	Name	Remote key	Description
4.	PEPS wearable		<ul style="list-style-type: none">• Customer can wear it on wrist and drive the car (ease of carrying and usage).• This perform dual functions of Passive entry/exit and Passive start (similar functions of Smart Key – Door lock / door Unlock/Tailgate opening / Start of vehicle)

OPENING AND CLOSING

Flip Key with Remote

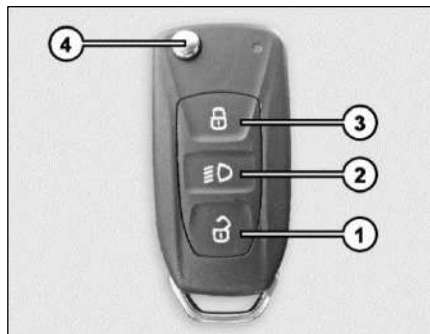

1. Unlocking all doors
2. Approach Light/Tail gate unlatch
3. Locking all doors
4. Folding key blade IN/OUT

1. Unlocking all doors

Pressing the unlock button (1) of remote will unlock all the Doors.

2. Approach light

Press approach light button (2) once, low beam, position, roof lamp will turn 'ON'. This feature helps to find and reach the parked vehicle or to reach home in dark/cloudy condition after parking. Red LED will be flash on the remote. To switch 'OFF' the approach lights, press and release the same button or it automatically turns 'OFF' after certain time.

Tail gate Unlatch

To unlatch the Tale gate, long press the approach light button (2) on remote for more than 2 sec.

NOTE

Tail gate once unlatched will not get lock automatically with doors.it will locked by slamming it

3. Locking all doors

Pressing the Lock button (3) once. Remote locks all the doors of the vehicle.

4. Folding key blade IN / OUT

Press button (4) to flip out the key blade. For folding, press the button (4) and fold the key blade inside.



NOTE

Key Blade should not be folded without pressing the button. Also, it should not be forced in any direction apart from folding direction to avoid damage to Flip Mechanism

Flip key Features

Vehicle search

In vehicle locked condition if lock button on remote key is pressed the turn indicators of vehicle flashes 4 times.

Automatic activation of immobilizer

If key is removed from ignition, the engine will be immobilized automatically even if you forget to lock the vehicle.

For few variant, Ignition off is required to immobilize the vehicle.

Auto locking / unlocking of doors / auto relock

- Vehicle doors get automatically locked when all doors are closed and the vehicle speed crosses 10 kmph. Please refer section starting and driving for more information.
- When ignition key is taken out all the doors get automatically unlocked.

- For few variant, when ignition is turned off all the doors get automatically unlocked.

Also, when unlocked with remote key and if no door is opened within 30 seconds, vehicle doors get automatically locked.

Anti-grab / anti-scan coding

The remote control set of this security system is protected against the use of devices called 'scanners' and 'grabbers' which can record and reproduce some types of remote codes.

Sleep Mode

If remote key is not used for more than a week then its functionalities will turn to sleep mode. In such a case, to activate the remote key functionalities, open the door mechanically with the key blade.

NOTE

In case any button of the key is accidentally pressed for more than 20 seconds, the remote stops functioning till the time the button is pressed. The LED on the Remote also stops glowing. The function of the remote gets reinstated immediately when the user stops pressing the push button of remote.

OPENING AND CLOSING

Smart Key (if available)

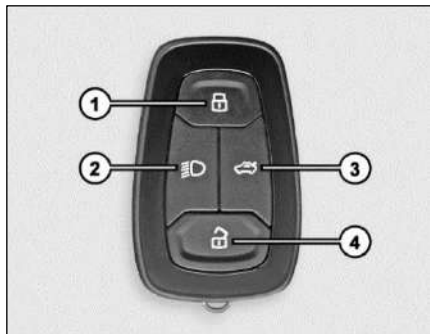

Keep the smart key with user to perform the passive access. It is used for locking, unlocking and starting the vehicle.

1. Locking all doors
2. Approach Light
3. Tail gate opening
4. Unlocking all doors

1. Locking all doors

Press the lock button once (1) to lock all the doors of the vehicle.

Successful lock will be indicated by two flashes of turn signal indicators.

2. Approach light

This feature helps to find and reach the parked vehicle.

When you press approach light button (2) once, low beam and position lamps will turn 'ON'.

To switch 'OFF' the approach lights, press and release the same button or it automatically turns 'OFF' after certain time.

3. Tail gate Opening

Press the lock button once (3) to unlock the tailgate.

4. Unlocking all doors

Press the unlock button once (4) to unlock all the doors.

Successful unlock will be indicated by one flashes of turn signal indicators.

NOTE

If smart key battery is low/drained or vehicle battery is low/drained, user can unlock and enter into vehicle by using mechanical key blade, which is present inside the smart key.

Key blade in/out



Slide the knob (1) to release the key. Pull the key blade (2) out.

Smart Key Features

Vehicle search

If lock button on smart key is pressed when the vehicle is locked, the turn indicators of vehicle flashes four times for the driver to locate the vehicle.

Automatic activation of immobilizer

If smart key will not found within the passenger compartment, engine will be immobilized and vehicle cannot be start.

Auto lock/unlock of doors/ auto re-lock

In case of PEPS variants, door will get unlocked when ignition is OFF by pressing start/stop button.

Vehicle doors get automatically locked when all doors are closed and the vehicle speed crosses 10 kmph. Please refer section starting and driving for more information.

Also, when unlocked with remote key and if no door is opened within 30 seconds, vehicle doors get automatically locked.

Vehicle doors get automatically locked after 180 sec .time elapsed, when vehicle power is in OFF mode and vehicle all doors in locked condition .After doing other than driver door transition (open → closed) then vehicle all door will get unlocked and an audio warning will be sounded for nine sec to alert that the key is inside the vehicle.

Anti-grab / anti-scan coding

The remote control set of this security system is protected against the use of devices called 'scanners' and 'grabbers' that can record and reproduce some types of remote codes.

Important

- Don't press unlock button on remote in the vicinity of your vehicle, as you may accidentally unlock your vehicle.
- For battery replacement procedure, refer 'MAINTENANCE' section.
- Don't remove the battery connection of the vehicle while the vehicle has been locked by remote.

OPENING AND CLOSING

Smart key Precautions:

1. If smart key is close to radio transmitter, it may interfere with the operation of the smart key.
2. If the smart key is near a mobile two way radio system or a cellular phone, then it will not work correctly.
3. If another vehicle's smart key is being operated close to your vehicle, the signal will fluctuate.

WARNING

Keep the smart key away from electromagnetic materials which block electromagnetic waves to the key surface.

NOTE

In case any button of the key is accidentally pressed for more than 20 seconds, the remote stops functioning till the time the button is pressed. The LED on the Remote also stops glowing. The function of

the remote gets reinstated immediately when the user stops pressing the push button of remote.

Force Panic operation

Force Panic ON operation: When the vehicle is in off condition and the lock and unlock buttons are pressed at the same time, the force panic operation becomes active. In this case, the turn indicators start flashing and the vehicle starts to honk.

Force Panic OFF operation: To deactivate the force panic operation, press any button on the smart key.

Vehicle Alarm & Security

To prevent automobile thefts, the anti-theft system makes use of an anti-theft alarm (ATA). On detection of any unauthorized access, the BCM triggers the horn (acoustic alarm) and flashes the turn indicators.

OPENING AND CLOSING

Doors

Door lock and unlock with key (if available)

The front doors can be locked or unlocked from outside using the key blade.

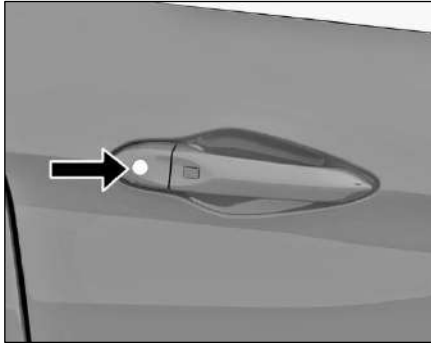

Insert the key in the slot and turn it clockwise to lock and anticlockwise to unlock the door.

Door locking and unlocking using door handle switch (DHS)

To lock/unlock all the doors without operating smart key button/ key blade. Press the door handle switch (DHS) provided on the driver door to lock/unlock all the four doors including Tail gate.

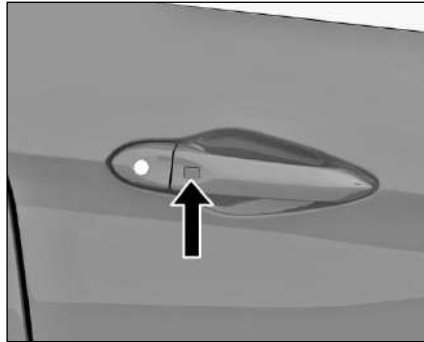

NOTE

- *Authentication range for smart key ranges from 1 to 1.5 meters from outside the respective door or tail gate.*

- *Passive entry works only when ignition is off.*

Locking without a key from inside



All the doors can also be locked from inside by pressing knob on driver door and independently on other doors respectively.

OPENING AND CLOSING

Opening the doors from inside



All doors can be opened from inside. To open, pull the door opening knob (1) and then lever (2).

Windows

Power windows (if available)

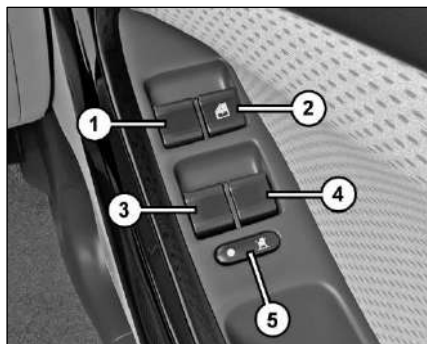

1. Front Window Winding Switch (Left)
2. Front Window Winding Switch (Right)
3. Rear Window Winding Switch (Left)
4. Rear Window Winding Switch (Right)
5. Inhibit Switch

Window glasses on all four doors can be operated by switches provided on the main control panel located on the

driver's arm rest. They work only when the key is in the 'IGN ON' position.

NOTE

Power windows can be operated for 30 seconds in 'IGN OFF' and 'KEY OUT' positions, provided the doors are closed.

Express down (if available)

Window glasses can be opened by a single long press of the switch. Express down feature is provided for the driver's door only.

OPENING AND CLOSING

Individual switches

Individual window winding switches have been provided on the front passenger and rear doors.

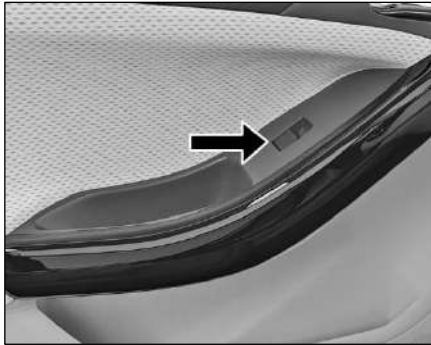

Glasses are wound up or down by pulling or pressing the switch.

WARNING

While raising the glass, take care to avoid fingers/hands getting trapped between glass and the door frame.

Inhibit switch



Inhibit switch ON

When switch is pressed, red light turns 'OFF'. The individual switches provided on rear and front passenger door cannot



be operated. However, it can be operated from the switches on driver's arm rest.

Inhibit switch OFF

When switch is pressed, red light turns 'ON'. The individual switches provided on rear and front passenger door can be operated. It can also be operated from the switches on driver's arm rest.



WARNING

- If children operate the windows they could get trapped, particularly if they are left unsupervised. There is a risk of injury.
- Activate the window inhibit feature when children are travelling. When leaving the vehicle, always take the key with you and lock the vehicle. Never leave children unsupervised in the vehicle.

OPENING AND CLOSING

Manual Window Winding

(if available)

Use window winder handle for lowering or raising up window glasses manually where power windows are not provided.

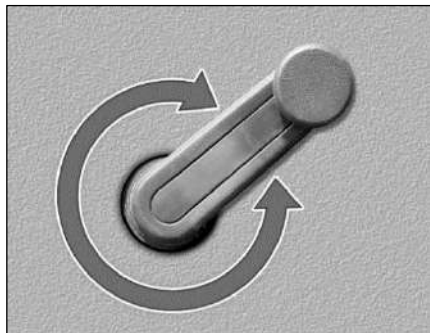

Opening the bonnet

1. Make sure that the engine is switched off and vehicle is in neutral gear with the parking brake applied.
2. Pull the bonnet release lever. The bonnet will pop up slightly.



For MT



For AMT

3. Lift the bonnet slightly and with your finger and slide the secondary lock lever under the center of the bonnet.

OPENING AND CLOSING



NOTE

Make sure that the wiper arms are not raised before you lift up the bonnet to avoid damaging the wiper arms and the bonnet.

4. Lift the bonnet up. Pull the bonnet stay rod from its clip and put the free end into the slot provided on frame.

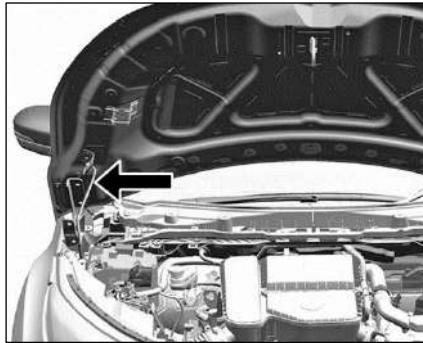

WARNING

- The stay rod can be hot enough to burn your finger right after driving. Touch the rod after it becomes cool enough.
- Put the stay rod into the hole correctly. If the rod drops off, your body may be caught below the bonnet.

Closing

1. To close the bonnet, hold the bonnet by one hand, disengage the stay rod and clamp it back properly.
2. Lower the bonnet close to the bumper, then let it drop down.

WARNING

Make sure that the bonnet is correctly locked or it can fly up unexpectedly when you drive.

OPENING AND CLOSING

Tail gate Opening

NOTE

Some variants may have multiple options.

Option I

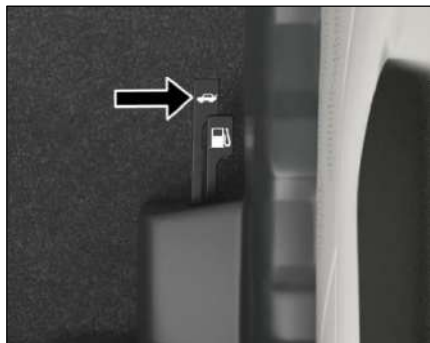

To open the tail gate, pull the lever located at the right hand side below the driver's seat and lift the tail gate.

Option II

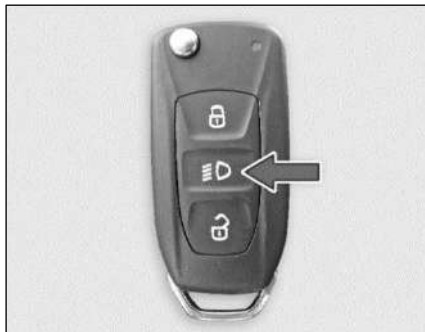

Remote operated Tail gate unlatching can be done through long press (2 sec) approach light button on remote key.

Option III



To release the tailgate, press the tail gate button on the remote.

NOTE

Press the tail gate button on smart key and press the tail gate door handle switch within 30 seconds to open it.

Option IV

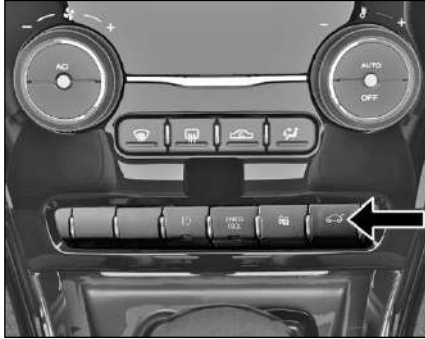

To open the Tail gate, press the switch located on fascia switch.

NOTE

- If vehicle is in locked condition then Tail gate unlatch via fascia switch will work only in ignition ON condition.
- If vehicle is in unlocked condition then Tail gate unlatch via fascia switch works in ignition ON as well as ignition OFF condition.

Option V



If the vehicle is locked, tail gate is closed and tail gate DHS switch is pressed with valid smart key in the authentication range the tail gate gets unlatched.

On closing the tail gate door, it gets locked. While closing the tail gate, if doors are in locked condition and valid smart key is inside the trunk, then tail gate gets unlocked.

Option VI



Tail gate opened by using door key, the lock is located on the Tail gate.

For closing, pull the tail gate down and close it with a slight swing.

OPENING AND CLOSING

NOTE

- Once tail gate is opened, it will not get locked automatically with other doors.
- If the doors are unlocked, the tail gate can be unlocked via tail gate handle switch without smart key.
- Do not keep the smart key in the boot when you close the tail gate.

WARNING

Tail gate can't be locked using mechanical key/ flip key/ smart key. It has to be locked by slamming it.

Fuel lid

Option I

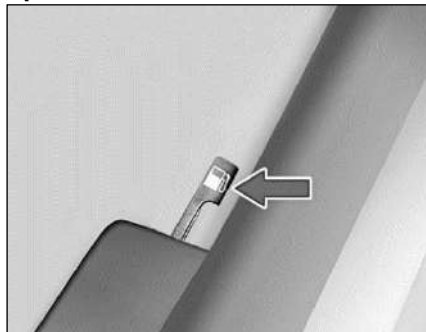

Option II

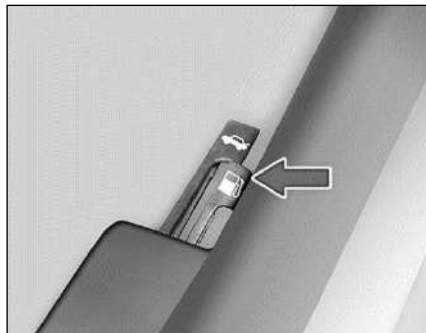

To release the fuel flap, pull the lever located at the right hand side below the driver seat.

For opening, open the fuel cap, turn it counter clockwise.



For closing, turn the fuel cap clockwise and gently push the fuel flap till it gets locked.

WARNING

- Fuel vapor is extremely hazardous. Always switch 'OFF' the engine before refueling and never

refill near sparks or open flames.
Do not use cell phone when you fill fuel.

- Do not continue adding fuel after the automatic shut 'OFF' function is operated if it is equipped on the fuel station. Overfilling the fuel tank could damage the fuel system.

NOTE

- *To fill up the fuel, the Engine must be stopped by turning OFF the Ignition Key / Start-Stop button.*
- *Remove the fuel filler cap slowly, and wait for any hissing to stop. The fuel may be under pressure and may spray out.*
- *If fuel cap needs replacement, make sure that it is replaced by a genuine cap at the TATA MOTORS authorized service center.*

OPENING AND CLOSING

Power Sunroof

Opening and Closing the power sunroof

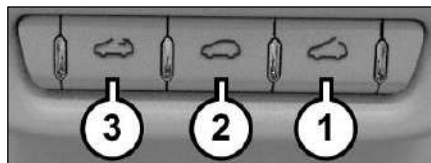

To operate the sliding sunroof, push the switch as shown in figure position of the switches (1) to (3).

Switch Position	Function
1	Open tilt/vent sunroof
2	Close sliding / tilt sunroof
3	Open sliding sunroof

NOTE

You must switch on the ignition to operate the power sunroof. After switching off the ignition, you can still open or close the power sunroof for several minutes as long as the driver

or front passenger door has not been opened.

Sunroof Open / Close Position

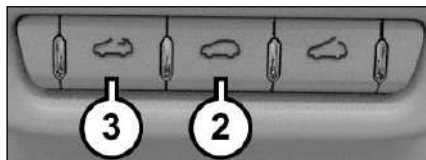

1. Open: When the sunroof is closed



Press the sunroof control button (3) to open, both the sunroof and sunroof glass will slide all the way to comfort position automatically.

Long press the control button (3) to enter manual mode and stop the sunroof at desired position or full open position.

To stop the sunroof movement at any point, press the sunroof control button (2) momentarily.

2. Close: When the sunroof is fully open

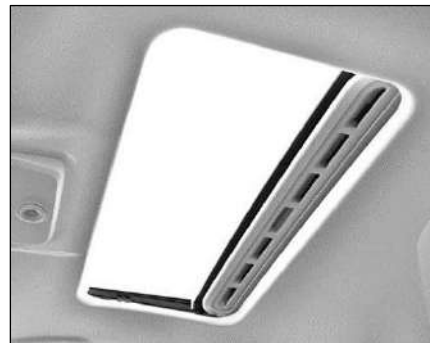

OPENING AND CLOSING

Press the sunroof control button (2) to close, glass will slide all the way to.

Long press the control button (2) to enter manual mode and stop the sunroof at desired position.

NOTE

Sunroof will not close automatically during sunroof close operation. Sunroof should be closed manually.

Sun Shade Open/Close Position

To fully Open/Close the Sun Shade

1. Manual Open sunroof -Handle Manual Mode



Hold shade handle by hand, and pull and move sunroof in the rearward direction.

Sunroof can move to full open position.

NOTE

Sunroof can open completely only when glass is close position, vent position, or between open and vent position.

2. Manual Close sunroof -Handle Manual Mode

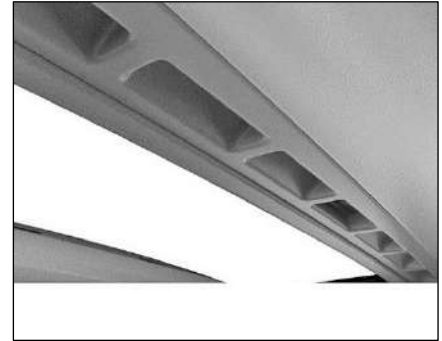

Hold shade handle by hand, and push and move sunroof in the forward direction.

Sunroof can move to full close position.

NOTE

Sunroof can close completely only when glass is close position, vent position, or between open and vent position.

OPENING AND CLOSING

Sunroof Tilt/vent Position

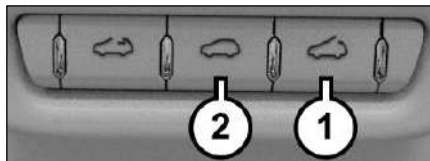

1. To Tilt/vent the sunroof open

Push the sunroof control button (1) to tilt/vent upward.

2. To close the sunroof Tilt/vent

Press the sunroof button (2) to close tilt/vent.

Pinch protection for the power sunroof are as follows:

1. Pinch protection has a range 4 mm to 200 mm from the cutout.
2. Pinch force is 100 N and above.
3. Pinch protection can help reduce the risk of pinching injuries when closing the power sunroof.
4. If the power sunroof closing meets resistance or there is something in the way, the power sunroof opens again immediately.
 - a. Check why the power sunroof did not close.
 - b. Try to close the power sunroof again.

Authorized Dealer/Service Center immediately.

WARNING

- Without pinch protection, the power sunroof will close with enough force to cause serious personal injury.
- Always be careful when closing the power sunroof.
- Pinch protection cannot prevent fingers or other parts of the body from being pressed against the edge of the roof; may result in injuries.

NOTE

If the power sunroof malfunctions, pinch protection may not function properly. Visit the TATA MOTORS

Re-Initializing the power sunroof

Initializing the sunroof

1. If the sunroof is stopped midway due to a discharged battery or power failure, you need to recalibrate the starting point of the sunroof. In addition, the following cases need reset of the starting point for the sunroof.



2. The sunroof does not completely close or open by operating the switch once.



3. The sunroof slides back to close. But the operation does not stop even after a complete close and tilts up the sunroof.



4. The opening gap remarkably decreases for the sliding open or tilt up.
5. Operation of the sunroof switch does not do anything or work properly.
6. The operating process is not same as before due to discharged or disconnected battery.

OPENING AND CLOSING

DASHBOARD AND FEATURES

Cockpit

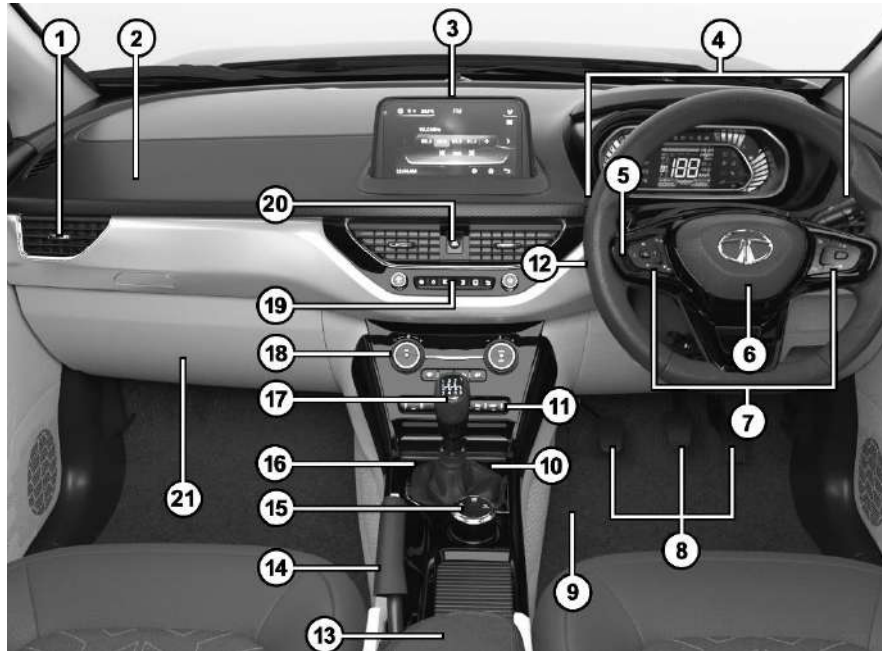

1	A.C. Air vent
2	Air Bag (PAB)
3	Infotainment Display (if available)
4	Combi-Switch
5	Horn pad
6	Air Bag (DAB)
7	Steering mounted controls (if available)
8	Controls (as available)
9	Foot Rest
10	USB Port
11	Fascia switches
12	Start/Stop switch
13	Foldable Arm-Rest (if available)
14	Parking Brake Lever
15	Drive Control knob
16	Power socket
17	Gear Shift Lever
18	HVAC Control panel
19	Infotainment Switches
20	Hazard Warning Switch
21	Glove Box

NOTE: All location shown may not be applicable to your vehicle / Variants.

DASHBOARD AND FEATURES

Instrument Cluster – Digital Cluster (Version 1)

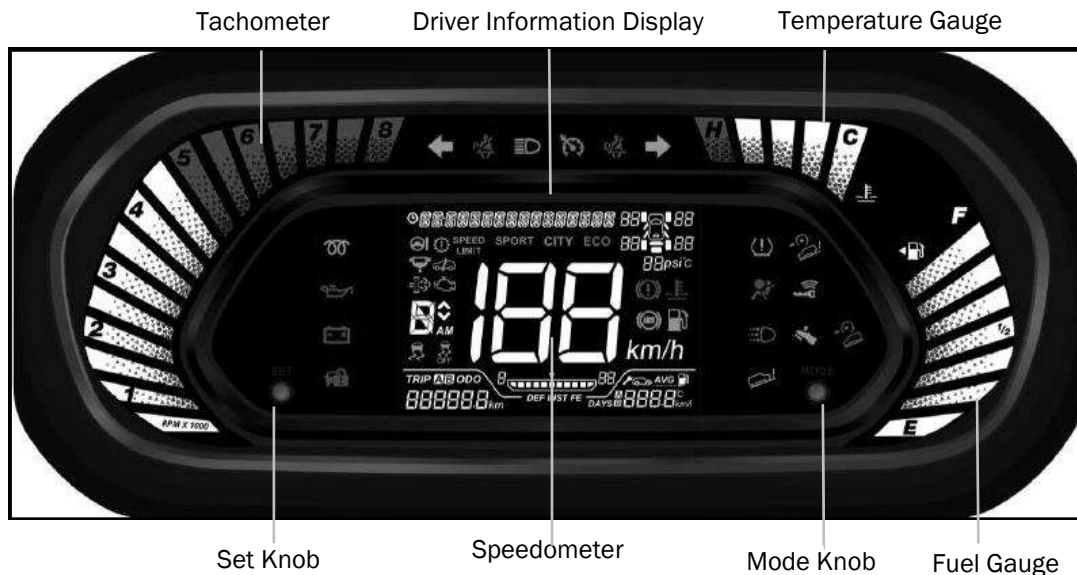

**NOTE: All indicators shown may not be applicable to your vehicle.
Above image is only for reference. Red bar values shown may change as per vehicle.**

DASHBOARD AND FEATURES

Instrument Cluster – Digital Cluster (Version 2)

Tachometer

Driver Information Display

Temperature Gauge



Set Knob

Speedometer

Mode Knob

Fuel Gauge

**NOTE: All indicators shown may not be applicable to your vehicle.
Above image is only for reference. Red bar values shown may change as per vehicle.**

DASHBOARD AND FEATURES

Speedometer



Speedometer indicates the vehicle speed in kmph.

NOTE

At every key IN and ignition ON, the Instrument Cluster LED gauges moves to MAX. and returns to non position.

Tachometer



Tachometer indicates engine speed in revolutions per min (rpm).

WARNING

- Whenever engine is accelerated beyond safe rpm, tachometer display turns RED. In such case, reduce the engine RPM immediately.
- Do not drive the vehicle with a high engine rpm. This may cause damage to the engine and reduce its life.

NOTE

- At every key IN and Ignition ON, tachometer LED display moves from Min to MAX and returns to first bar ON.
- This is a welcome strategy and a self-check feature.

DASHBOARD AND FEATURES

Fuel Gauge

When the ignition switch is in “ON” position, fuel gauge gives an approximate indication of the amount of fuel in the fuel tank. In indication window, “F” stands for full and “E” stands for empty.



When fuel telltale is moving, in the tank nears empty, low fuel warning tell-tale light glows. Fill fuel as soon as possible.

If fuel is not filled even after Low fuel warning Tell tale ‘ON’, first bar in fuel gauge will start blinking to indicate more severe low fuel warning.

NOTE

- *On inclines or curves, the fuel gauge may fluctuate or the 1st bar may blink or low fuel telltale may turn ON earlier than actual due to the movement of fuel in the tank.*
- *On inclines, curves, braking and sudden acceleration due to the movement of fuel in the tank, the fuel level display may fluctuate or the low fuel level warning lamp may illuminate earlier than usual. Always check the fuel level when the vehicle is on level road.*
- *When the ignition switch is in the “ON” position, this gauge gives an approximate indication of the amount of fuel in the fuel tank*

and it takes few seconds to stabilize after the ignition is turned ON.

WARNING

- Running the fuel tank too low or empty can cause engine to stall and could endanger User and passengers. User must stop and obtain additional fuel as soon as possible after low fuel warning telltale turns ON.
- Do not continue adding fuel after the automatic shut off function is operated if it is equipped on the fuel pump. The sensor in the fuel tank may misjudge the amount of fuel remaining.
- Low fuel warning symbol shall blink if there is any fault in the system. Take vehicle to the Tata Motors authorized service station if the symbol starts blinking.

DASHBOARD AND FEATURES

Temperature Gauge

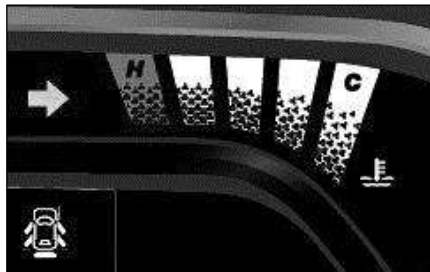

When the ignition switch is in the “ON” position, this gauge indicates the engine coolant temperature. The indicator should be within the normal, acceptable temperature range i.e. between “H” and “C”. If the indicator approaches “H”, overheating is indicated by a RED bar.



If the coolant temperature is very high, the engine coolant temperature tell-tale light flashes and you will hear an audio warning. In this case, stop the vehicle, switch the engine ‘OFF’ and allow it to

cool down for some time. Contact the nearest TATA MOTORS Authorized service centre immediately for rectification.





NOTE

At every key in and Ignition ON, Temperature Gauge Bars move to H and come back to C position. This is welcome strategy and self-check feature.





WARNING

- The red progress bar indicates overheating due to high coolant temperature that may damage the engine. If you continue to drive the vehicle in this case, it can result in severe engine damage or even fire.
- Never remove the radiator pressure cap from the radiator when the engine is hot. Do not restart the engine until the problem has been duly attended.

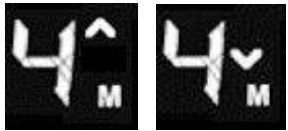

Driver Information System

Driver Information	System Image	Description
Odometer		<p>This indicates distance travelled by the vehicle. The odometer reading does not return to “0” when maximum value is reached; the display will freeze the maximum value.</p>
Trip meter A & B	 	<p>The trip meter can be used to measure the distance travelled on short trips or between fuel stops. It can be reset to “0”. The trip meter reading becomes “0.0” after it crosses 9999.9 km.</p>
Service reminder		<p>This indicates how many days/kilometres are left until service is due. If service is overdue, it will display “0” km or “0” days and a spanner symbol will blink every time ignition is ON for a few seconds. Never reset the display between service intervals as it may give incorrect readings. The information is retained in the service interval display even after the vehicle battery is disconnected.</p> <p>NOTE: 1. This option is for indicative purpose only. Keep track of your odometer reading and follow the maintenance schedule. 2. Spanner symbol will be continuously “ON” when service is overdue.</p>



DASHBOARD AND FEATURES

Driver Information	System Image	Description
Gear Recommendation		<p>Up or down arrow will be displayed on DIS to shift a gear up or down. No arrow shall be displayed when the selected gear is as per the Vehicle dynamics.</p> <p>NOTE: Following the recommended Gear shall result into a better Fuel Economy.</p>
Outside Ambient Temperature		<p>Displays outside ambient temperature in °C.</p> <p>NOTE: The temperature sensor is in the front bumper of the vehicle, therefore the temperature reading can be affected by heat reflection from the road surface, engine heat and the exhaust from surrounding traffic. This can cause an incorrect temperature reading when speed is under low speeds or when stopped. If display shows '--', take your car to TATA authorized service Centre.</p>
Door Ajar (As applicable)		<p>All four door and trunk lid are indicated independently when respective door or trunk lid is open.</p> <p>NOTE: If any other door is open roof lamp will be 'ON' provided that roof lamp switch is in  position.</p>

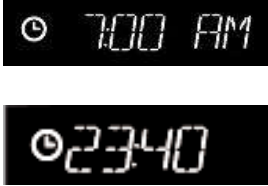



DASHBOARD AND FEATURES

Driver Information	System Image	Description
<p>Door Ajar (As applicable)</p>		<p>This warning will be indicated when driver door is open.</p> <p>NOTE: If any other door is open roof lamp will be 'ON' provided that roof lamp switch is in  position.</p>
<p>Clock</p>		<p>When the ignition switch is in the "ON" position, it shows the time 12 Hour or in 24 Hours mode as per selection.</p> <p>Note: 1. You can do clock settings in Infotainment system when Infotainment is present in the vehicle.</p> <p>2. Whenever the battery terminals or related fuses are connected User must reset the clock time. This feature is available when ignition switch is in ON position.</p>







DASHBOARD AND FEATURES

Driver Information	System Image	Description
Drive Mode (AMT)		<p>“M” indicates Manual Drive mode. “A” indicated Automatic Drive mode.</p>
Current Gear Indication	 <p>- Neutral - Reverse</p>	<p>Current gear engaged by the transmission shall be displayed on DIS. This feature is applicable to both AMT and Manual transmission variant. In case of Manual transmission, the gear display is as per the User selection. IN case of AMT, the display is as per the Automatic selected gear.</p> <p>Note: If  is displayed, it means 'Fault' condition. In such case, take vehicle to authorized TATA MOTORS service station. In case of Manual Transmission the Gear number will be displayed when the clutch is fully released.</p>







DASHBOARD AND FEATURES

Driver Information	System Image	Description
Rotate Steering		<p>“ROTATE STEERING” text warning comes ‘ON’ for 4 seconds when electronic steering column is in locked state. Rotate Steering slightly (left or right) to unlock it.</p> <p>Note: If text warning “ROTATE STEERING” is displayed even after rotating the steering, it means ‘Faulty’ condition. In such case, take vehicle to authorized TATA MOTORS service station.</p>
Key batt low (for PEPS)		<p>“KEY BATT LOW” text warning comes ‘ON’ for 4 seconds when UID key battery is low.</p>
Key out of range (for PEPS)		<p>“KEY OUT OF RANGE” text warning comes ‘ON’ for 4 seconds when UID key is not inside the vehicle.</p>
Press Clutch (for PEPS)		<p>“PRESS CLUTCH” text warning comes ‘ON’ for 4 seconds when clutch is not pressed to crank the vehicle.</p> <p>Note: This text warning is applicable for MT vehicle.</p>
Press Brake (for PEPS))		<p>“PRESS BRAKE” text warning comes ‘ON’ for 4 seconds when BRAKE is not pressed to crank the vehicle.</p> <p>Note: This text warning is applicable for AMT/AT vehicle.</p>



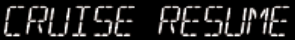

DASHBOARD AND FEATURES

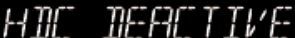
Driver Information	System Image	Description
Service due		“SERVICE DUE” text warning comes ‘ON’ for 4 seconds when service is overdue.
Low brake fluid		“LOW BRAKE FLUID” text warning comes ‘ON’ for 4 seconds when brake fluid is low.
Low fuel		“LOW FUEL” text warning comes ‘ON’ for 4 seconds when low fuel warning telltale comes ‘ON’ and fuel level is low.
Over speed		“OVER SPEED” text warning comes ‘ON’ for 4 seconds when display speed crosses 120 Km/Hr.
Take a break		“TAKE A BREAK” text warning comes ‘ON’ for 4 seconds when driver drives continuously for prolonged duration. Note: “TAKE A BREAK” text warning comes ‘ON’ for 4 seconds again with specific duration if vehicle is not stopped and continuously driven.
Engine locked		“ENGINE LOCKED” text warning comes ‘ON’ for 4 seconds when engine is unable to crank.
Unable to resume (as applicable)		“UNABLE TO RESUME” text warning comes ‘ON’ for 4 seconds when cruise function is unable to resume/activate.

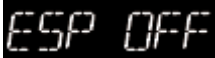

DASHBOARD AND FEATURES

Driver Information	System Image	Description
Cruise off (as applicable)		“CRUISE OFF” text warning comes ‘ON’ for 4 seconds when cruise function is deactivated.
Cruise cancelled (as applicable)		“CRUISE CANCELLED” text warning comes ‘ON’ for 4 seconds when cruise function is cancelled by user.
Cruise resume (as applicable)		“CRUISE RESUME” text warning comes ‘ON’ for 4 seconds when cruise function is resume.
Cruise Override (as applicable)		“CRUISE OVERRIDE” text warning comes ‘ON’ for 4 seconds when cruise function is override by user.
Happy Birthday (as applicable)		“HAPPY BIRTHDAY” text warning comes ‘ON’ for 4 seconds on owner’s birthday.
HDC Active (as applicable)		“HDC ACTIVE” text warning comes ‘ON’ for 4 seconds when hill descent control function is active.
HDC deactive (as applicable)		“HDC DEACTIVE” text warning comes ‘ON’ for 4 seconds when hill descent control function is deactivated.



DASHBOARD AND FEATURES

Driver Information	System Image	Description
ESP off		<p>“ESP OFF” text warning comes ‘ON’ for 4 seconds when ESP is made off.</p>
TPMS - Tyre Pressure Monitoring System (as applicable)		<p>Tyre pressure information for individual tyre with pressure values will be displayed with “psi” unit on DIS if tyre pressure is within defined range.</p>
	  	<p>Text warning “LO” near to respective tyre and tyre symbol will blink if tyre pressure is low.</p> <p>Tyre pressure values will be displayed with “psi” unit for remaining tyres.</p> <p>“CHECK TYRE” for 1s and “PRESSURE” for another 1s text warning comes ON for 2 cycle within 4 secs if tyre pressure is LOW.</p>



DASHBOARD AND FEATURES

Driver Information	System Image	Description
TPMS - Tyre Pressure Monitoring System (as applicable)	 <p>The image shows a central tyre icon with a pressure gauge. The top-left and bottom-right corners display '30' and the top-right and bottom-left corners display '32'. The word 'HI' is on the left and 'psi' is at the bottom. Below the icon are two black bars with white text: 'CHECK TYRE' and 'PRESSURE'.</p>	<p>Text warning “HI” near to respective tyre and tyre symbol will blink if tyre pressure is High.</p> <p>Tyre pressure values will be displayed with “psi” unit for remaining tyres.</p> <p>“CHECK TYRE“ for 1s and “PRESSURE” for another 1s text warning comes ON for 2 cycle within 4 secs if tyre pressure is HIGH.</p>
	 <p>The image shows a central tyre icon with a pressure gauge. The top-left and bottom-right corners display 'AL' and the top-right and bottom-left corners display '32'. The word 'AL' is on the left and 'psi' is at the bottom. Below the icon are two black bars with white text: 'CHECK TYRE' and 'PRESSURE'.</p>	<p>Text warning “AL” near to respective tyre and tyre symbol will blink if air is leakage.</p> <p>Tyre pressure values will be displayed with “psi” unit for remaining tyres.</p> <p>“CHECK TYRE” for 1s and “PRESSURE” for another 1s text warning comes ON for 2 cycle within 4 secs if air is leakage.</p>

DASHBOARD AND FEATURES

Driver Information	System Image	Description
TPMS Tyre Pressure Monitoring System (as applicable)	 <p>The image shows a digital display with a central tyre icon. Above the icon, the text 'HI' is on the left and '31' is on the right. Below the icon, '30' is on the left and '32' is on the right. At the bottom right, there is a 'c' symbol. Below the main display, two lines of text are shown: 'HIGH TYRE' and 'TEMPERATURE'.</p>	<p>Text warning “HI” near to respective tyre and tyre symbol will blink if tyre temperature is High.</p> <p>Tyre temperature values will be displayed with °C unit for remaining tyres.</p> <p>“HIGH TYRE” for 1s and “TEMPERATURE” for another 1s text warning comes ON for 2 cycle within 4 secs if tyre temperature is High.</p>
	 <p>The image shows a digital display with a central tyre icon. Above the icon, two dashes '--' are on the left and '30' is on the right. Below the icon, '32' is on the left and two dashes '--' are on the right. At the bottom right, there is a 'psi' symbol. Below the main display, a line of text is shown: 'TPMS ERROR'.</p>	<p>Text warning “- -”near to respective tyre and tyre symbol will blink if sensor has fault.</p> <p>Tyre pressure values will be displayed with “psi” unit for remaining tyres.</p> <p>“TPMS ERROR” text warning comes ON for 4 seconds when TPMS sensor has fault.</p> <p>Note:</p> <p>If text warning “- -” is displayed, it means ‘Fault’ condition. In such case, take vehicle to authorized TATA MOTORS service station.</p>

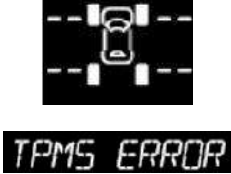
DASHBOARD AND FEATURES

Driver Information	System Image	Description
<p>TPMS Tyre Pressure Monitoring System (as applicable)</p>		<p>Text warning “--” near to all the tyre and tyre symbol will blink if TPMS system has fault “TPMS ERROR” test warning comes ON for 4 seconds when TPMS system has fault.</p> <p>Note: If text warning “- -” is displayed, it means ‘Fault’ condition. In such case, take vehicle to authorized TATA MOTORS service station.</p>
<p>Tata motors</p>		<p>“TATA MOTORS” text warning comes ‘ON’ for 4 seconds when ignition is turned ‘ON’. This is part of the welcome strategy.</p>

DASHBOARD AND FEATURES

1. Instantaneous fuel economy (IFE)



It indicates fuel economy of current drive when Ignition is turned 'ON'.

The display does not show actual value unless vehicle is moving.

NOTE

- IFE will vary frequently as per driving pattern.
- IFE display does not show Fuel Economy of last drive.
- The indication on the display screen may be delayed if fuel consumption is affected by driving pattern.
- For km/l setting, the indicated maximum value of INST FE is 30 km/l. No more than 30 shall be indicated on the display even if the actual INST FE is higher than 30 km/l.

2. Average fuel economy (AFE)



Trip A



Trip B

Average Fuel Economy A/B will reset to '0' whenever Trip meter A/B is reset.

Average Fuel Economy will be displayed as '--' for initial 0.5 km of respective trip. Once 0.5 km distance is covered, Average Fuel Economy will be displayed.

Even after 0.5 km distance covered for particular trip, if Average Fuel Economy is displayed as '--', then take your vehicle to TATA MOTORS Authorized Dealer/Service Center.

NOTE

- AFE value is estimate of fuel economy. It may vary significantly based upon driving conditions, driving habits and condition of vehicle.
- Average fuel consumption will get Reset to '0' when battery is removed and refitted.
- For AFE, the indicated maximum value is 30 km/l. No more than 30 shall be indicated on the display even if the actual AFE is higher than 30 km/l.

3. Distance to empty (DTE)



It indicates approximate distance in 'km' that your vehicle can travel with available fuel in tank.

DTE values may vary significantly based on driving conditions, driving habits, and condition of the vehicle. It is an estimate value of the available driving distance.

If low fuel warning light glows, fill the fuel tank immediately regardless of the DTE figure.

NOTE

If DTE is displayed as '—', then take your vehicle to the TATA MOTORS Authorized Dealer/Service Center.

The DTE will update with new value when fuel is added more than 5 Litres at a

time. DTE will provide rolling text warning as 'REFUEL' at approximately 47 km distance to empty. DTE working range is from 47 km to 1999 km.

If low fuel warning light turns 'ON', fill the fuel tank immediately regardless the value of displayed DTE.

The distance to empty value is an estimate of the available driving distance.

If vehicle is not on level ground and negative of battery has been disturbed, the DTE function may not operate correctly.

DASHBOARD AND FEATURES

Driver Information System (DIS) setting

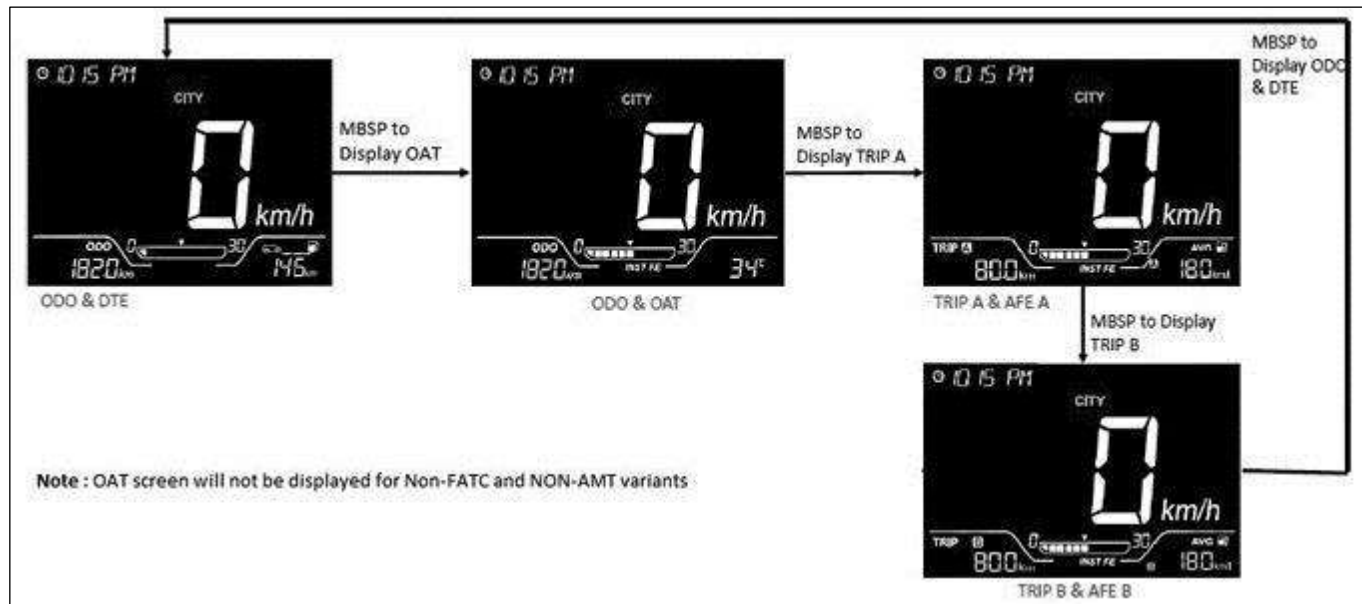

MBSP- Mode Button Short Press

Driver Information Settings for Illumination and Clock setting

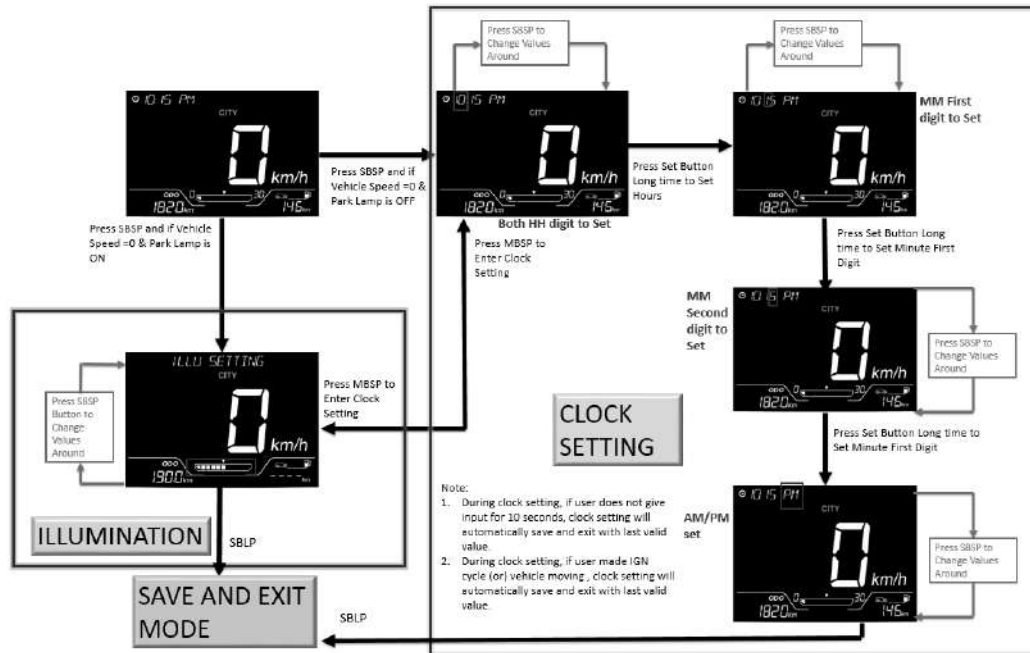

MBSP- Mode Button Short Press;

SBLP- Set Button Long Press;

SBSP- Set Button Short Press

DASHBOARD AND FEATURES

Instrument Cluster Illumination



For Instrument Cluster illumination level settings, it is necessary to turn the Park Lamp 'ON' and then Press the 'SET' knob on Instrument Cluster.

Press 'SET' knob to change the illumination intensity level in 5 steps. A delayed press on the 'SET' knob for a selected intensity will confirm it.



NOTE

This is a welcome strategy and a self-check feature.





WARNING

The Clock and Instrument Cluster Illumination settings should be done only when the vehicle is in stationary condition for safety purpose.





Tell Tales

Warning Lamps	Color	Indicator	Remarks
Malfunction Indication Lamp (MIL)	Amber		<ol style="list-style-type: none"> 1. The lamp comes on when ignition is switched 'ON'. Once engine is started, it turns 'OFF'. 2. It remains 'ON' for any engine related fault that may increase emission levels of the vehicle beyond the regulatory norms. Contact the TATA MOTORS Authorized Dealer/Service Center for rectification.
Check Engine Lamp	Amber		<ol style="list-style-type: none"> 1. The lamp comes on when ignition is switched 'ON'. Once engine is started, it turns 'OFF'. 2. Illuminates continuously if a fault arises in Engine Management System. Contact the TATA MOTORS Authorized Dealer/Service Center.
Immobilizer (if available)	Red		<ol style="list-style-type: none"> 1. The lamp comes on when the system disables engine start if the original key is not used. 2. Lamp blinks: Vehicle is in immobilized condition when key is not inserted. 3. Lamp ON: Problem with key/system. Contact TATA MOTORS Authorized Dealer/Service Center. 4. Lamp OFF: Normal condition (Authenticated user) and engine will start.



DASHBOARD AND FEATURES

Warning Lamps	Color	Indicator	Remarks
Pre-Heat indicator / Glow Plug indicator (Diesel)	Amber		<ol style="list-style-type: none"> 1. The lamp comes on when ignition key is in 'ON' position. 2. Start the engine only after this indicator goes 'OFF'.
Turn Signal	Green		<p>Indicates direction indicated by the turn signal.</p> <p>While you operate the left/right turn indicator, the turn signal blinks along with the buzzer (when ignition is 'ON'). The direction indicator arrow on the instrument cluster flashes along with the selected external indicator lights. Both tell-tale lights will blink simultaneously when the hazard switch is pressed irrespective of whether the ignition ON or OFF. A tick-tock sound will be heard in both cases.</p>
High Beam	Blue		<p>The lamp comes on when the high beam headlamps are switched 'ON' or flashed.</p>
Low Oil Pressure indicator	Red		<ol style="list-style-type: none"> 1. The lamp comes on when ignition is switched 'ON' and goes 'OFF' once required engine oil pressure is developed after starting the engine. 2. If the low oil pressure indicator does not glow or remains 'ON' when the engine is running, it indicates a fault in the electrical circuit/lubrication system. Contact the nearest TATA MOTORS Authorized service centre to rectify the issue.



DASHBOARD AND FEATURES

Warning	Color	Indicator	Remarks
Battery charging	Red		The lamp comes on when ignition is switched 'ON'. Once engine is started, it turns 'OFF'. If it remains 'ON' while the engine is running, it indicates that the battery is not getting charged or having the lower charge. In such cases, attempt to charge the battery with 3000 engine rpm for 15 min and see if battery telltale goes off after one ignition ON-OFF. Even after 15 minutes, charging the battery telltale keeps 'ON' then switch off all unnecessary electrical equipment and contact the nearest TATA motors authorized service center.
Airbag status	Red		The lamp comes on when ignition is switched 'ON' and goes 'OFF' in approx. four seconds. If it continuously blinks then contact the TATA MOTORS Authorized Dealer/Service Center immediately.
Park Brake / Brake Fluid Low / EBD malfunction	Red		<p>Illuminates momentarily when ignition is switched 'ON'. Once parking brake is re-released, it turns 'OFF'. If it remains 'ON', it indicates.</p> <ol style="list-style-type: none"> 1. Brake fluid level is low. 2. Park brake is applied & turns 'OFF' when it is released. 3. ABS/EBD system has a fault.
Cruise Control lamp (if available)	Green		This symbol lights up when the 'IGN' is turned 'ON' and shall go 'OFF' after four seconds. The Cruise Control is used to indicate the status of cruise control system to the driver. If the lamp is on, it indicates that the cruise control feature is activated.
EPAS	Amber		<p>Illuminates momentarily when ignition is switched 'ON'.</p> <p>Illuminates when there is a fault in the EPAS. Contact the TATA MOTORS Authorized Service Centre immediately.</p>





DASHBOARD AND FEATURES

Warning Lamps	Color	Indicator	Remarks
High Coolant Temperature	Red		<p>The lamp comes on when ignition is switched 'ON' and goes 'OFF' in approx. four seconds.</p> <p>If the engine overheats due to higher coolant temperatures, this indicator blinks along with an audible buzzer. Contact your nearest TATA MOTORS authorized service Centre immediately. When the engine coolant temperature reaches the maximum limit, the tell-tale lights blink with a RED colour and you will hear an audio warning.</p> <p>Note: Do not remove the radiator pressure cap from the radiator when the engine is hot. Do not restart the engine until the problem has been duly attended.</p>
DPF (Diesel) (if available)	Amber		<p>The DPF warning light or symbol switches 'ON' continuously to indicate that the DPF needs to eliminate the trapped pollutants (particulate matter) through the re-generation procedure. The warning light or symbol switch 'ON' only when driving conditions require the driver to be notified.</p> <p>DPF 'ON' does not indicate a malfunction.</p> <p>To switch off the warning light or symbol, keep the car running on road until regeneration is complete (ideally at 3rd gear, 50-80 kmph, with engine speed over 2000 rpm).</p> <p>The process normally takes about 20 minutes.</p> <p>The warning light or symbol remains off during the entire DPF regeneration procedure</p> <p>If the procedure is not followed, MIL lamp will switch ON, along with DPF lamp on Instrument cluster.</p>





DASHBOARD AND FEATURES

Warning Lamps	Color	Indicator	Remarks
Low Fuel indicator	Amber		<p>The lamp comes on momentarily when ignition is switched 'ON'. The symbol lights up continuously if fuel level in the tank is low. Fuel needs to be filled immediately.</p> <p>Note: The tell-tale warning light will start flashing if there is any fault in the fuel system. Contact the nearest TATA MOTORS Authorized Dealer/Service Center immediately.</p>
ABS	Amber		<p>Illuminates when ignition is switched 'ON' and goes 'OFF' in 3 seconds. Illuminates continuously if there is any malfunction in ABS. Normal braking system will be operational without assistance of ABS. Contact a TATA MOTORS Authorised Service Centre immediately.</p>
Driver Seat belt indicator	Red		<p>Driver Seatbelt Reminder</p> <p>The driver seatbelt warning indicator remains ON, when ignition is turned ON.</p> <p>The warning lamp remains ON as long as the driver seatbelt is not fastened.</p> <p>If seatbelt remains unbuckled and vehicle goes above 15 kmph, then final audio warning will go more than 90 seconds.</p> <p>Note: Once the seatbelt is fastened the buzzer and warning lamp turns OFF. Seatbelt reminder remains OFF when reverse gear is engaged.</p>



DASHBOARD AND FEATURES

Warning Lamps	Color	Indicator	Remarks
Key Not Detected (if available)	Amber		This lamp comes on when the Valid Smart key is not detected inside the vehicle.
Press Clutch / Brake Pedal to Start Engine (if available)	Amber		This lamp comes on with IGN ON till user presses the clutch pedal to start the engine.
Water in fuel indicator (Diesel)	Amber		The lamp remains on if excess water is accumulated in the fuel filter. It Illuminates momentarily when ignition is switched 'ON'. When this lamp remains 'ON', drain the water immediately to avoid serious damage to the fuel injection system. This lamp also turns ON when Fuel Filter Clogging warning is activated.
Daytime running lamps DRL (if available)	Green		This lamp comes on when the Daytime Running lamp is 'ON'.
Door Ajar lamp (if available)	White / Red		All four door and Tail gate are indicated independently when the respective door or tail gate is open.





DASHBOARD AND FEATURES

Warning Lamps	Color	Indicator	Remarks
Front Passenger Seat belt indicator	Red		<p>Front Passenger Seatbelt Reminder The front passenger seatbelt warning indicator turns ON when ignition is turned ON. If adult occupies front passenger seat, the warning lamp remains ON as long as the front passenger seatbelt is not fastened. If seatbelt remains unbuckled and vehicle goes above 15 kmph, then final audio warning will go more than 90 seconds.</p> <p>Note: Once the seatbelt is fastened the buzzer and warning lamp turns OFF. Seatbelt reminder remains OFF when reverse gear is engaged.</p>
ECO	Green		<p>Illuminates momentarily when ignition is switched 'ON'. When ECO lamp is ON, it indicates the car is in 'Economy' drive mode, which helps to achieve a better fuel economy.</p>
CITY	Blue		<p>Illuminates momentarily when ignition is switched 'ON'. If CITY lamp is ON, it indicates 'City' drive mode, which helps to achieve optimum torque and fuel economy.</p>
SPORT	Amber		<p>This symbol comes ON when SPORT driving mode is activated when more torque is required.</p>

DASHBOARD AND FEATURES

Warning Lamps	Color	Indicator	Remarks
Speed limit warning indicator	Amber		<p>When the vehicle speed crosses 80 kmph, then speed limit warning indicator turns 'ON' along with an audio chime for every two minutes (audible warning).</p> <p>When the vehicle speed is reduced below 75 kmph, then the speed limit warning indicator and the audio warning will turn off.</p> <p>If vehicle speed crosses 120 kmph, the speed limit warning indicator flashes along with an audio warning for every two sec one beep (audible warning) until the vehicle speed is above 120 kmph.</p> <p>When the vehicle speed is reduced below 115 kmph, then speed limit warning indicator turns 'ON' along with an audio chime for every two minutes one beep (audible warning)</p>
AMT Fault (If available)	Amber		<p>Illuminates momentarily when ignition is switched 'ON'.</p> <p>Illuminates continuously when there is a fault in Automated Manual Transmission system. Contact a TATA MOTORS authorized Service Centre immediately.</p>

DASHBOARD AND FEATURES

Warning Lamps	Color	Indicator	Remarks
TPMS	Amber		<p>This symbol comes on and blink for 4 second if Tyre Pressure is LOW/HIGH, Tyre temperature is HIGH, Tyre air pressure leakage. After 4 second symbol will continuously ON till warning is present.</p> <p>This symbol comes on and blink for 20 second if TPMS system has fault and TPMS Sensor fault / missing. After 20 second symbol will continuously ON till fault is present, Please take your vehicle to nearest TATA authorized service center at the earliest.</p>
HDC Warning lamp (If available)	Amber		Illuminates if Hill Decent Control System is activated. If continuously ON then HDC system is at fault condition, Please take your vehicle to nearest TATA authorized service center at the earliest.
HDC ON (If available)	Green		Illuminates momentarily when ignition is switched 'ON'. This symbol comes on when the HDC function is activated in the vehicle.
HHC warning lamp (If available)	Amber		Illuminates momentarily when ignition is switched 'ON'. If continuously on then HHC, system is in fault condition. Please take your vehicle to TATA authorized service center at the earliest.
Electronic Stability Program (ESP) (If available)	Amber		Illuminates momentarily when ignition is switched 'ON'. If continuously ON then ESP system is at fault condition, Please take your vehicle to nearest TATA authorized service center at the earliest.

DASHBOARD AND FEATURES

Audio Reminders (as available)

1. Key-in reminder/audio warning

If you forget the key inside the vehicle when you leave the ignition in 'OFF' position and door is open, an audio warning will sound. Remove key to stop the warning.

If no key is detected in the vehicle

If the vehicle is in ACC ON/IGN ON and the customer takes the smart key out of the vehicle and closes the last door, an audio warning will be sounded for nine seconds to alert that the key is not in the vehicle.

NOTE

In this condition customer needs to bring the smart key inside the vehicle

2. Parking lamp 'ON' reminder

If you forget to turn OFF the park lights and driver door is open, an audio warning will be started. Do not forget to turn OFF your park lights as it may drain the vehicle's battery.

3. Parking brake 'ON' reminder

If Park Brake is applied and vehicle is driven, Tell tale will turn 'ON' and buzzer will provide audio warning continuously. Disengage the park brake to stop audio warning.

4. Reverse Gear reminder

If reverse gear is engaged, the buzzer sound will alert you for 1 second.

5. Driver Seat Belt reminder

If seatbelt is not fastened and vehicle goes above 15 kmph, then final audio warning will go on for more than 90 seconds. Seat belt tell-tale light will remain continuously ON when audio alarm is active.

6. Front passenger Seat Belt reminder

If front passenger has not fastened seat-belt and if vehicle speed goes above 15 kmph, then final audio warning will go on for more than 90 seconds. Seat belt tell-tale light will remain continuously ON when audio alarm is active.

NOTE

Fasten the seatbelt to stop audio warning.

7. Drive mode chime

When user switches drive mode from city to eco or city to sport (as available), sound warning for 1 second will be given to alert user.

8. Electronic Steering Column Lock (ESCL) chime

This feature informs the driver to rotate steering wheel when ESCL gets engaged accidentally.

DASHBOARD AND FEATURES

9. AMT fault reminder

If Fault occur in AMT, 3 second audio warning will alert you.

10. Tyre Pressure Monitoring System

Audible warning for 4 second will be given to alert User. If Tyre Pressure is low, Tyre Pressure is high, Tyre temperature is high.

Also Audible warning for 20 second will be given to alert User. If TPMS system has fault and TPMS Sensor fault or missing.

11. PEPS Key not detected chime

If PEPS key is not detected in the vehicle, then sound warning will be given to alert User.

Combi-Switch (RH Stalk)

(if available)

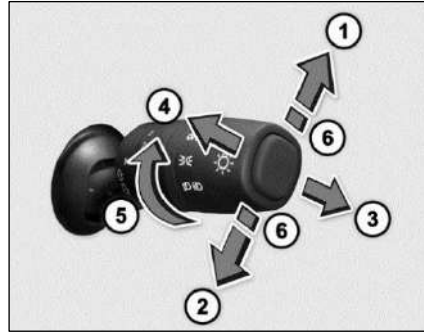

- 1. Left Turn signal** - Move the lever fully upward.
- 2. Right Turn signal** - Move the lever fully downward.

NOTE

When the turn is completed, the signal will cancel and the lever will return to its normal position.



- 3. High beam** - Move the lever forward to select the high beam function.

Pull the lever back to normal for low beam.

- 4. High beam Flash (spring return)**

To flash the high beam, pull the lever towards you from the normal position. It will return to its normal position when you release it.

5. Headlamp Rotary Switch

- OFF Position**  All lamps will remain 'OFF'.
- Parking Lamp**  Rotate stalk to turn 'ON' the Parking lamps.
- Low Beam**  Rotate stalk to turn 'ON' the Low Beam function.

DASHBOARD AND FEATURES

iv. Auto Light



The headlights will be automatically switched ON depending on ambient light conditions (while entering a tunnel or when it is twilight).

6. Day Time Running Lamps (DRL)

Day time Running Lamps (DRL) are used to increase the visibility of the vehicle to other drivers during daytime.



- i. To activate and deactivate DRL, keep the ignition switch is 'ON' position and switch the parking lamp ON-OFF twice within approx. three seconds.
- ii. Activation and Deactivation of DRL can be done by DRL soft switch, which is available on the Head Unit Display.

7. Lane Change Signal

To signal a lane change, move the lever slightly up or down to the point where the turn signal light begins to flash, but the lever does not latch. The turn signal will flash six times automatically.

Head lamp leveling rotary switch

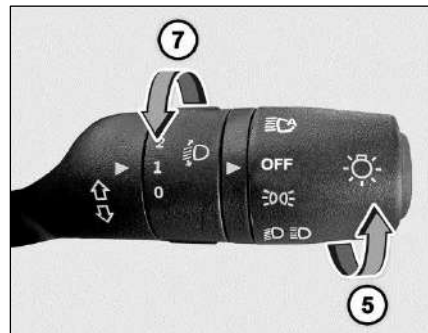

Inner rotary switch on right hand stalk is provided for head lamp leveling. With the inner rotary switch, Head lamp leveling can be done with head lamp in Low Beam and in 'ON' position. Select correct position before start of trip, when the vehicle is stationary. Depending on the number of passengers and luggage in the vehicle headlamp focus may change. This can be adjusted by rotating the knob to one of the three level positions.

Combi-Switch (LH Stalk)

(if available)

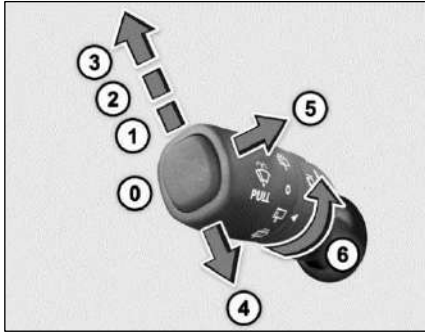

0) 'OFF' Position

The wiper is switched 'OFF'.

1) Intermittent wipe

Push the stalk upwards to operate intermittent wipe.



Inner rotary switch on left hand stalk is provided for intermittent front wiper delay. The switch has five delay timers.

2) Slow Wipe

Push the stalk towards position (2) for continuous slow wipe.

3) Fast Wipe

Push the stalk towards position (3) for continuous fast wipe.

4) Flick wipe (spring return)

Pull the stalk downwards and hold it for continuous wipe, the wiper continuously wipes across the windshield at low speed till the stalk is released.



5) Front Windshield Washer

- Pull the lever little longer, to spray the washer fluid on the windshield.
- The windshield wipers will operate for three cycles after the lever is released and for one more cycle after five seconds.



Auto front wipe

If your vehicle is fitted with rain and light sensor, the wipers will automatically wipe the windshield, if it senses rainfall. Make sure that the wiper stalk is in Auto position.

NOTE

When you crank the engine, the supply to washer motor is momentarily cut off.

DASHBOARD AND FEATURES

6) Rear Wash and Wipe

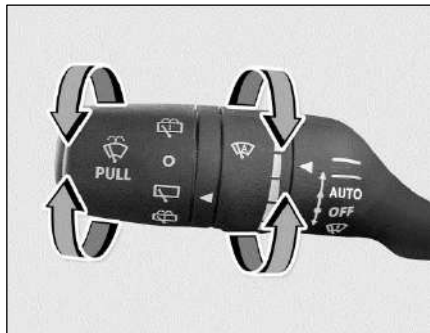

Rear Windshield / Wiper and Washer

Turn the rotary knob clockwise and release to operate rear windshield wash and wipe. The windshield wipers will operate for three cycles.



Rear Wipe

Turn the rotary knob counter clockwise such that it aligns its positions with arrow mark to operate rear windshield wiper continuously.



NOTE

Rear wiper will not work as long as tailgate is open.

Rear Windshield/ Wiper and Washer Switch

Turn the rotary knob counter clockwise such that it aligns its positions with the arrow mark and hold it to operate rear windshield wash and wipe function. It will return to 'Rear wipe' position as soon as it is released and continues to wipe.



NOTE

When you reverse the car with front wipers in 'ON' condition, the rear wiper will also be 'ON'.

WARNING

If you operate, wash and wipe function for more than 15 seconds the controller cuts off the supply to the washer motors to avoid overheating.

Rain/Light Sensor (as available)

The integrated rain and light sensor is mounted on front windshield glass to sense rain and light.

As per the input from sensor, the wipe and light functions will work automatically.

DASHBOARD AND FEATURES

Dashboard controls (if available)

Fascia switches are provided on the center console below HVAC control panel.

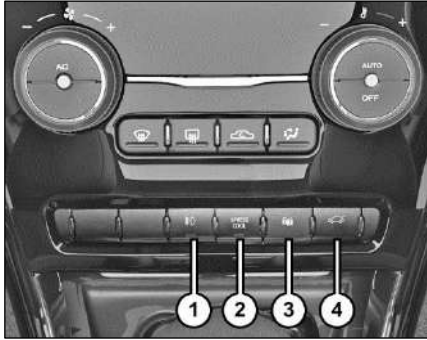

1. Front fog lamp switch
2. Xpress cool
3. Central lock/unlock
4. Tail gate opening

1. Front Fog Lamps (if available)

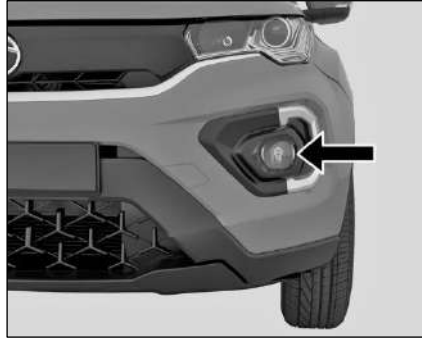

The front fog lamps are located on the front bumper. In poor visibility conditions due to fog, snow or rain, the fog lamps make visibility better and make it easier for other road users to see you. It turns to 'ON' when the fog lamp switch is turned on when the ignition is 'ON' and when the position and parking/ head lamp is 'ON'. An indicator on front fog lamp knob will come on when the front fog light is 'ON'.

Fog lamp as Cornering Lamp

The front fog lamps also function as cornering lamps to light up the area to the side of the vehicle, making night-time parking and turning safer.

2. Xpress Cool

This helps cabin to reach to comfort temperatures quickly by optimally setting the air conditioning to maximum cooling. Also, if required, the driver window will roll down to flush the hot air from inside the cabin.

For more information, please refer Climate control section.

3. Central lock/unlock

To open the door, press the Lock/unlock door switch located on the fascia switch.

4. Tail gate opening

To unlatch the tail gate, press the switch located on fascia switch.

DASHBOARD AND FEATURES

Steering mounted controls (LHS)

(if available)

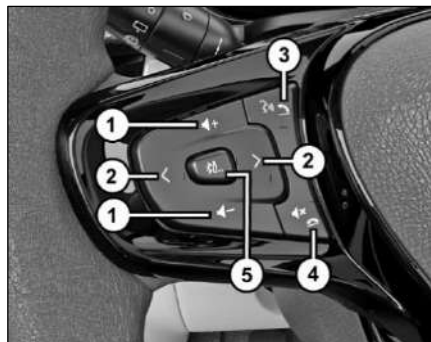

1. Volume



Press above switch to increase or decrease volume of music system / radio.

2. Seek forward/backward



Press above switch to change radio channels.

3. Receive calls/PTT (Push to Talk)

Press above switch to accept incoming call when a cell phone is connected via Bluetooth.



Voice Recognition

To start, press the voice activation button provided on the steering wheel. The system mutes/ pauses the currently played audio and you will hear a beep sound to indicate the activation of the voice recognition feature. The system displays the Voice Recognition screen on Infotainment to indicate activation of the feature.

NOTE

The system will start recognizing your voice command only after the beep. So, speak your command only after you hear the voice activation beep.

4. Mute/phone reject



Press above switch to reject or hang up a phone

call. It is also used to mute the volume of music system/radio.

5. Source

Press above switch to select the required source in the infotainment system i.e. USB, AM, FM and Bluetooth.



NOTE

For more information related to steering mounted controls, refer the infotainment manual.

((Refer link -<http://service.tatamotors.com/content/owners-manual>)if applicable)

Steering mounted controls (RHS) (If available)

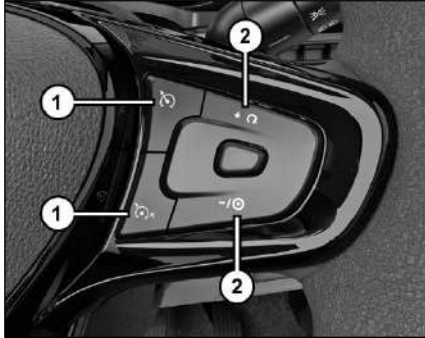

1a. Cruise control master switch



Cruise speed can be resumed only if cruise control is deactivated by applying the brake. To resume the previously set cruise speed, accelerate the vehicle to a speed is as per gear selected as below:

- 3rd gear approx. 30Kmph to 80Kmph
- 4th gear approx. 40kmph to 120Kmph
- 5th gear approx. 50kmph to 140Kmph

1b. Cruise control deactivating switch



There are two ways to deactivate cruise control:

- Applying brake / clutch.
Press deactivation switch on Steering Wheel

2a. Changing the set cruise speed



The set cruise speed can be adjusted using the buttons '+' (to increase) or '-' (to decrease) on steering wheel.

The speed increases and decreases on a single press.

The changed speed will be shown on the speedometer.

Keeping the switch pressed increases or decreases the speed continuously till the switch is re-released or maximum/minimum speed limit for particular gear is reached.

The set speed can also be increased by pressing the accelerator pedal till the desired speed is achieved and then pressing the 'SET' button.

The set speed can also be decreased by pressing the brake pedal (The cruise indicator will turn OFF) and slowing down to desired speed and then pressing the 'SET' button (The cruise control indicator will turn 'ON' again).

2b. Cruise set (reset) using speed increase (decrease) switch



- Press the cruise control master switch on steering wheel.
- Accelerate the vehicle to the desired speed.
- Make sure that the Clutch and Brake pedals are not pressed.
- Press the 'SET' button on steering wheel switch to set the desired cruise speed. The cruise control indicator on instrument cluster will turn 'ON'.
- Remove your foot from the accelerator pedal.

Once Cruise control is activated the vehicle automatically maintains the stored speed.

DASHBOARD AND FEATURES

Mic (if available)



Mic is provided on the roof near the roof lamp.

Infotainment System Display

Option I



Option II

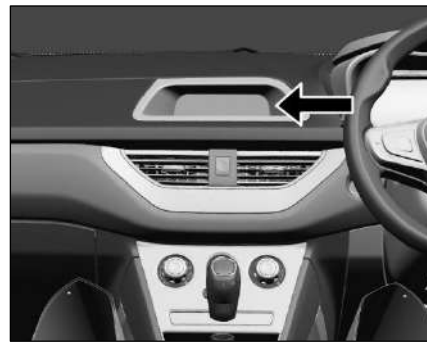

NOTE

For more information, refer infotainment manual.

((Refer link -<http://service.tatamotors.com/content/owners-manual>) if applicable)

DASHBOARD AND FEATURES

Speakers & Tweeter (if available)



Speakers and Tweeters are available in models with infotainment system. Provisions are given for music system and speakers on versions without infotainment system.

USB Port (if available)

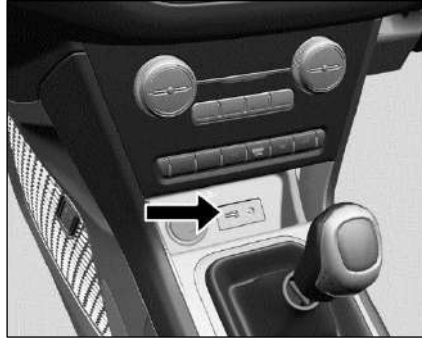

Connect your portable digital music players, pen drives etc. to this socket for playing music tracks through the vehicle's music system.

Power Socket (if available)



On center console

Two power socket are provided

1. On center console
2. Behind rear seat on LH side

The power socket will work when the ignition switch is in the "ACC" or "ON" position. This socket can be used to provide 12V (10A) power for electrical accessories.

DASHBOARD AND FEATURES



Behind rear seat on LH side

NOTE

- Use of unapproved electrical accessories can cause damage to your vehicle's electrical system.
- Make sure that any electrical accessories you use are designed to plug into this type of socket and rating.

Antenna

Option I

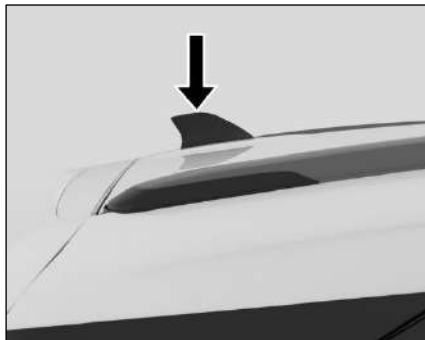

Shark FIN antenna is provided on the roof at rear end.

Option II

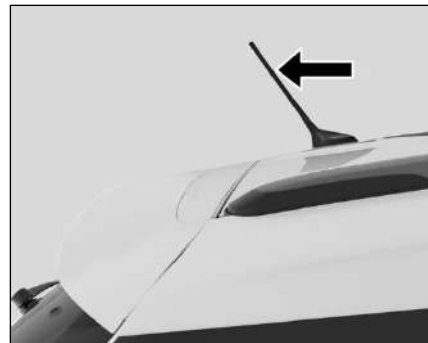

Antenna is located on the roof. Turn the antenna anticlockwise to remove it from the vehicle, if required.

DASHBOARD AND FEATURES

Roof Grab Handle (if available)

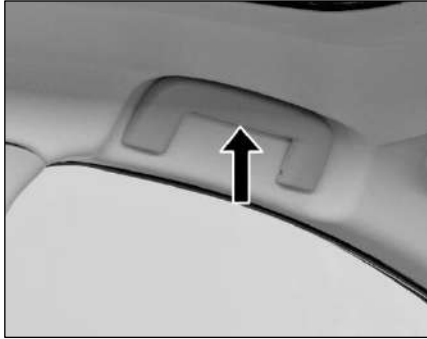

Grab handles are installed on the roof for all seats except for the driver's seat. These help the passengers to position themselves comfortably during the journey.

Roof Lamp

Interior roof lighting lamp is provided on the roof with inbuilt switch.



The switch has three positions:

ON - The lamp will turn 'ON' as long as the switch is in this position.



DOOR - In this position the lamp turns to 'ON' when either of the doors are opened. When the last door is closed, the lamp will turn 'OFF' with dimming. This helps



settling in the seat and inserting the key in the ignition switch. When the key is turned to the 'IGN' position, the lamp goes 'OFF' immediately.

OFF - In this position, the lamp will remain 'OFF'.



Boot Lamp (if available)

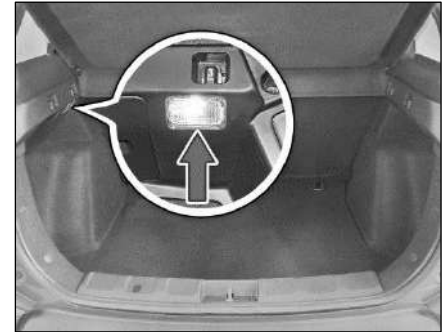

Boot lamp is provided in the rear luggage compartment to illuminate the luggage area.

It will be ON when tailgate is open and will be OFF when tailgate is closed.

DASHBOARD AND FEATURES

Front Lamp

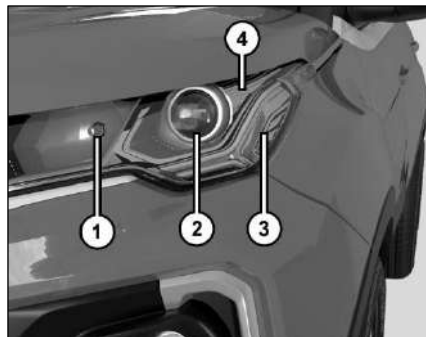

1. High beam lamp
2. Low beam lamp
3. Parking lamp / DRL
4. Turn indicator lamp

Lamp Condensation / Fogging Condition

Condensation is a natural phenomenon in Lamp. This occurs mainly because of atmospheric condition/weather change. During normal condensation, thin film of mist is visible on the inside surface of the exterior lens. Generally, this condition is considered normal and can be eliminated by turning on the headlamp with engine running or during normal driving conditions.

NOTE

- *Headlamp fogging/condensation is natural occurrence and headlamp assembly replacement will not be necessary to resolve the issue.*
- *High-pressure washer jet direct on vent system of lamp are not recommended, there might be possibility of water ingress causing heavy fogging.*

Tail Lamp (as available)



1. Turn indicator
2. Stop lamp
3. Parking / Position lamp
4. Reverse lamp

Storage Compartment

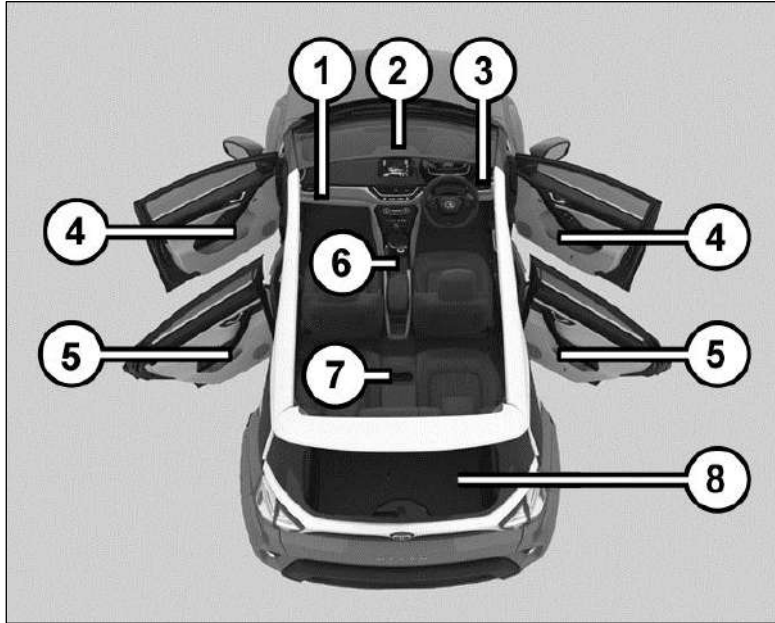

1. Chiller glow box
2. Wallet storage(near roof lamp)
3. Driver side coin box

4. Utility pockets on front doors
5. Utility pockets on rear doors
6. Center console

7. Foldable arm rest
8. Tailgate Compartment

STOWAGE AREAS

1) Glove box

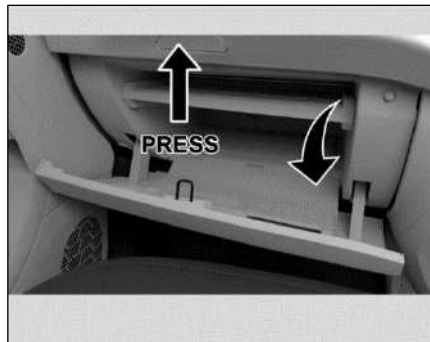

i) Opening and closing

To open - Press the knob and open the glove box flap.

To close - Lift glove box flap upward until it engages.

ii) Glove box illumination (if available)

The glove box lamp illuminates when the glove box flap is opened.

NOTE

Make sure that glove box flap is closed while driving.

iii) Stowage detail (if available)

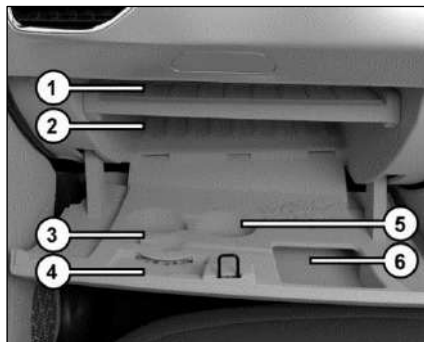

Following items can be stowage in glove box.

1. Owner's manual and other vehicle document
2. Chiller glove box
3. Pen holder
4. Visiting card
5. Cup holder
6. Receipts etc.

iv) Cooling facility (if available)

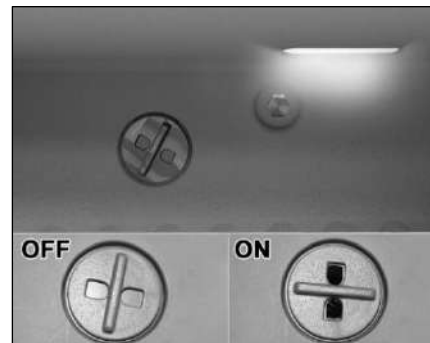

On selected models glove box is provided with a cooling facility. It cools the glove box only when the front A/C is ON. Shut OFF the vent by rotating the knob, whenever cooling is not required.

STORAGE AREAS

2) Wallet stowage (if available)

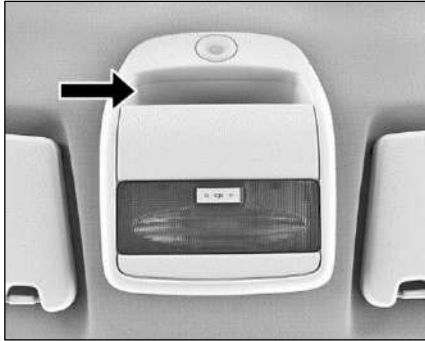

Place for keeping wallet is provided above the roof lamp.

3) Driver side coin box

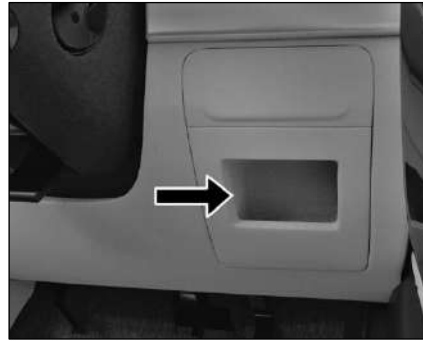

Stowage is provided on RH side of steering wheel for Coin, mobile and wallet.

4) Utility pockets on front doors

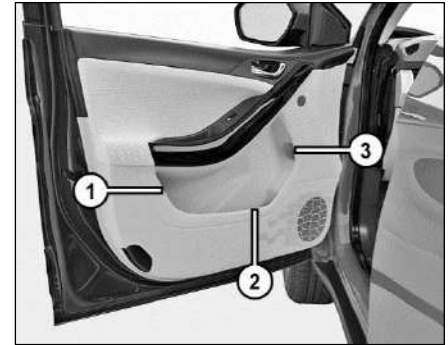

Utility pockets are provided on front doors and it can be used to keep following items.

1. Suitable water bottle
2. Magazine / paper / books
3. Umbrella

NOTE

Remove the water from umbrella and fold it properly before storing it in umbrella holder.

STOWAGE AREAS

5) Utility pockets on rear doors

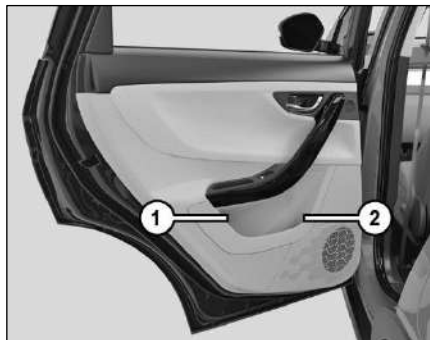

Utility pockets are available on rear doors and it can be used to keep following items.

1. Suitable water bottle
2. Magazine / paper / books

6) Center console

Option I

Stowage below arm rest

Stowage compartment is provided below the foldable arm rest for keeping cell phones, iPod's, chargers etc.



Tambour door



Tambour door is provided on center console. To access Tambour door, lift arm rest (1). Slide the shutter (2) to open and close the stowage area.

NOTE

Use cups, containers, bottles of right size and which have lids. The content could otherwise spill.

STORAGE AREAS

Option II

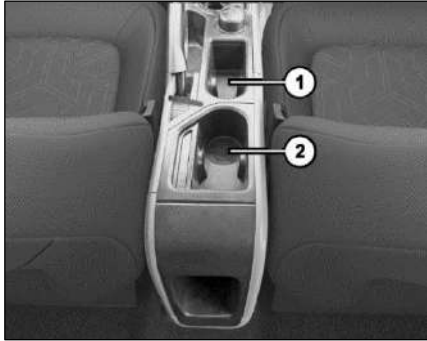

Following items can be stowage in Center console.

1. Pen & Coin holder
2. Cup holder

7) Stowage for rear passenger (if available)

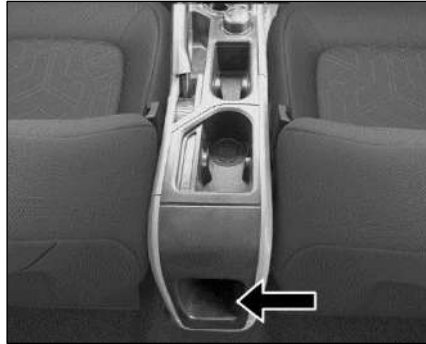

Stowage for the rear passenger is available on rear side of floor console between the front passenger seats. It can be used to keep phone and small items.

NOTE

Applicable for models where rear vents is not provided.

8) Foldable arm rest (if available)

A foldable arm rest has been provided in the rear seat. It also has two-cup holders, which can be accessed by opening the cover. When not required, fold the arm-rest back into the seat.



NOTE

Remove all items and cups before folding the cup holders. Use cups, containers, bottles of right size and which have lids. The content could otherwise spill.

STOWAGE AREAS

9) Tailgate Compartment (Luggage)



Store the luggage in tailgate compartment. You can keep suitcase, bags, etc.

WARNING

- Distribute the items of luggage as evenly as possible.
- Position heavy loads towards rear seat and low down in the trunk as possible.

- Do not allow occupants to travel in the luggage compartment.
- Do not place anything on luggage cover as it could obstruct driver's rear view. Also in case of an accident or sudden braking, it could cause an injury to occupants.

HOOKS (if available)

i) Coat Hook

Coat hangers are provided for rear passenger on both grab handles.



NOTE

- *The coat hook is not designed to carry heavy objects or luggage items.*
- *Do not hang hard, sharp-edged or fragile objects on the coat hook.*

STORAGE AREAS

ii) Hook for Purse holder

Hooks for holding purse are provided on both B pillar.



iii) Collapsible hook

Collapsible hook is provided for hanging small carry bags etc.

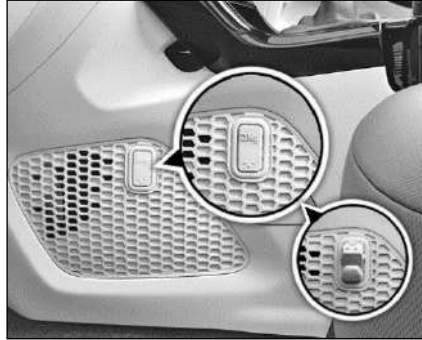

NOTE

Do not use these hooks for securing luggage like using nets etc. in the boot.

iv) Carrier hook in luggage compartment

Carrier hook is provided for hanging small carry bags etc. Load up to 3 kg is permissible.

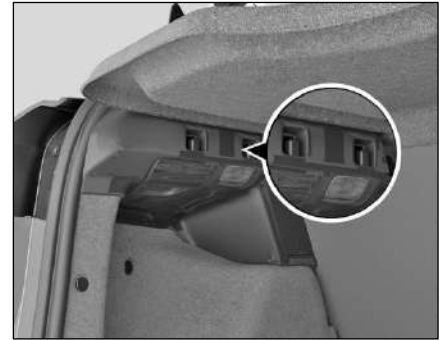

NOTE

Do not use these hooks for securing luggage like using nets etc.



CLIMATE CONTROL

The climate control regulates the temperature set in cabin based on user settings and it can be set in temperature settings.

Air Distribution- The air is distributed through the vents in the passenger compartment as shown below:



CLIMATE CONTROL

Air vents

Air vents are available on the dashboard. The direction of air flow can be adjusted using sliders on the respective vents.



Centre Air Vents (Front)



Side Air Vents (Front)

Rear AC vents (if available)

Rear AC vents are available between two front seats. It can be switched 'ON' provided that front AC is switched 'ON'.

It can be switched 'ON/OFF' by rotating switch. The speed can be increased by rotating the knob towards 'HIGH'.



CLIMATE CONTROL

HVAC Controls (if available)

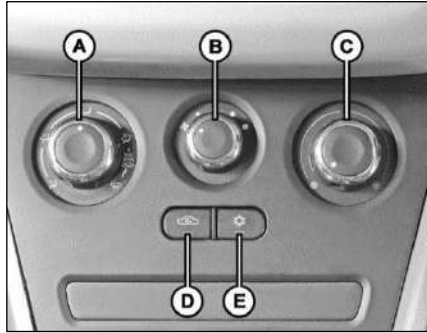

- A. Air Distribution Control
- B. Blower Speed Control
- C. Temperature Control
- D. Fresh / Recirculation air mode
- E. AC ON/OFF Switch

A. Air distribution control



This is to select the air distribution pattern as described in the table.

	Directs air through the center and side air vents
	Directs air through the center, side and foot well vents
	Directs air through the foot well air vents
	Directs air through the defroster & foot well vents (Default fresh air mode)
	Directs air through the defroster vents (Default fresh air mode)

B. Blower Speed control



This is to turn 'ON' the blower and select desired blower speed.

CLIMATE CONTROL

C. Temperature control



The temperature control knob allows you to adjust the temperature. The temperature can be increased by rotating the knob towards the red segment (clockwise) and decreased by rotating it towards the blue segment (anti-clockwise).

D. Fresh / Recirculation air mode

Press the switch to activate / deactivate air recirculation mode.



Press to 'ON' or 'OFF'

Recirculation mode: (Indicator light 'ON')

Air inside the passenger compartment recirculates. No fresh air enters the compartment.



Always use when:

- Driving on a dusty road or through tunnel.
- On signals or slow traffic to avoid traffic pollution.
- Maximum cooling is required.

Fresh Air mode: (Indicator light 'OFF')

Fresh air is drawn into the vehicle.

Always use when:

- Discomfort is felt or windows are fogging up.
- Using  or  air flow modes during demist / defrost.
- Using normal heating mode.

E. AC ON/OFF



Press the button to switch ON/OFF the AC. The indicator lamp in the button will light up when AC is ON.

NOTE

The AC can be switched 'ON' only if the blower is 'ON' and engine is running.

When AC is switched 'ON', engine idling RPM increases marginally to adjust the AC compressor load.

When desired temperature is achieved AC trips 'OFF' automatically.

NOTE





- *Condensate may drip from the underside of the vehicle when it is in cooling mode. Traces of water on the ground are normal and are not a sign of leakage or malfunction.*
- *Ventilate the vehicle for a brief period during warm weather. This will speed up the cooling process and the desired vehicle interior temperature will be reached quickly.*
- *Never cover the air vents or air intake grills in the vehicle interior.*
- *If the AC is not used for a long period, such as during winter, it may not give the best performance when you start using it again. Operate the AC at least once a month to maintain optimum performance.*

- *While you start the vehicle after a long duration (more than 15 days), follow the procedure for better AC performance:*
 - *Start the vehicle and allow the engine to idle for 2-3 minutes. AC should be off in this period.*
 - *Switch the AC on and run it for another 2~3 minutes while the engine idles. This circulates the refrigerant and oil to lubricate the internal parts of the air-conditioning system.*

CLIMATE CONTROL

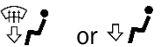
Functions and Settings

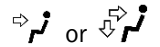
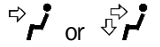
Here are the recommended basic settings of the control elements of air conditioning system for the respective operating modes. These may vary depending on individual requirements and weather conditions:

Functions Settings	Control Knob Position			Button Position	
	A. Air Flow Direction	B. Blower Speed	C. Air Temperature	D. Fresh / Recirculation air mode	E. AC ON / OFF
Normal heating		2 nd or 3 rd dot	Desired temp.	Fresh air mode.	As desired
Quick heating		To MAX speed and then 2 nd or 3 rd dot	To the extreme right up to the stop	Briefly switch ON to Fresh air mode then Recirculation	As desired
Normal Cooling		1 st to 3 rd dot	Desired temperature	Recirculation mode	Switched ON
Quick Cooling		To MAX speed and then 2 nd or 3 rd dot	To the extreme left up to the stop	Recirculation mode	Switched ON
Demisting		2 nd or 3 rd dot	Desired temperature	Fresh air mode (Default)	Switched ON (Optional)
Defrosting		To MAX speed	Desired temperature	Fresh air mode (Default)	Switched ON (Optional)

General Description:

FATC system controls the in-cabin temperature of the vehicle automatically and provides maximum passenger convenience regardless of outside weather conditions.

Fully Automatic Temperature Control (FATC) (if available)

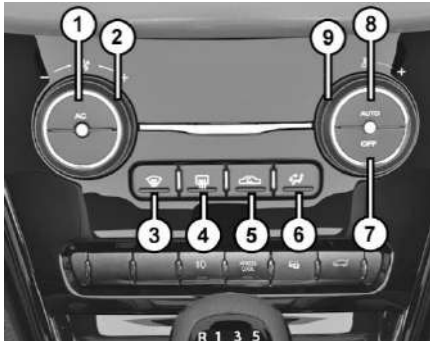

1. AC compressor ON/OFF button
2. Blower speed control knob
3. Maximum defrost button

4. Rear window demister button
5. Fresh air / recirculation button
6. Air distribution (mode) button
7. OFF mode
8. Auto ON selection button
9. Temperature control knob

Display unit



FATC display is shown on main display screen.

FATC functions can be controlled using both the FATC control panel and the touch screen display.

Whenever the user presses any push button or turns the rotary knob, then the display unit will show the relevant Climate Information.

Also, when the display is not in climate mode then climate information will be displayed on the all-time display available on the top bar.

1. AC ON / OFF Button:

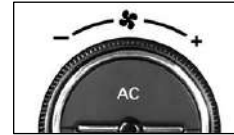

Press the AC ON/OFF button to turn the air conditioning ON or OFF. The AC icon activated on the display when the AC is ON.

CLIMATE CONTROL

2. Blower Speed Control Knob:



Rotate the knob clockwise to increase & anti-clockwise to decrease the blower speed.

3. Max Defrost Button:

- A. This button directs the main airflow towards windscreen for faster defrosting. (It also overrides any mode selection you may have made).
- B. When you turn off the button, the system returns to its former settings.



NOTE

For your safety make sure you have a clear view through all the windows before driving.

4. Rear Window Demister Button:

This button turns the rear window demister ON or OFF. The system will be deactivated after 15 min of continuous operation.



5. Fresh Air/Recirculation Button:

- A. When the recirculation button or LED is switched 'ON', air from the vehicle's interior is sent throughout the system.
- B. When the recirculation button is switched to 'OFF', air from outside enters into the cabin (fresh mode). Whenever discomfort is felt, switch to fresh air mode.



NOTE

The outside air intakes for the climate control systems are at the base of windscreen. Keep this area clear from leaves and other debris.

Use recirculation mode for faster heating and cooling. However, keeping the system in recirculation mode - particularly when the AC is in OFF - can cause fogging of windows.

NOTE

When reverse gear is selected, air inlet may switch to recirculation mode if it is in fresh air mode, to prevent exhaust fumes from entering the cabin.

6. Air Distribution (Mode) Button:

In AUTO mode, the FATC system will regulate the mode automatically. However, user override is possible with the use of MODE button to select the desired airflow mode.



Each time you press the MODE button, the display shows the mode selected.

	Directs air through the center and side air vents
	Directs air through the center, side and foot well vents
	Directs air through the foot well air vents
	Directs air through the defroster & foot well vents (De-fault fresh air mode)

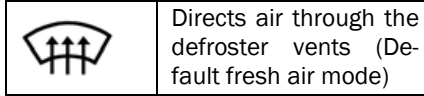

7. OFF Mode:



Press the OFF button to switch the system 'OFF'. OFF will be displayed on the infotainment screen.

8. Auto ON selection button



To put the automatic climate control in fully automatic mode:

A. Press the 'AUTO' button.

- B. Set the desired temperature by turning temperature control knob. The display will show all the functions during 'AUTO' mode.
- C. The system automatically selects the proper mix of conditioned and / or heated air that will, as quickly as possible, raise or lower the interior temperature to your preference.
- D. When you set the temperature to its lower limit (Lo) or its upper limit (Hi), the system runs at full cooling or heating only. It does not regulate the interior temperature.

NOTE

In 'AUTO' mode, the FATC system will regulate the blower speed automatically.

CLIMATE CONTROL

Semi-automatic Operation

You can manually select various functions of the climate control system when it is in fully automatic mode. All other features remain automatically controlled. Making any manual selection causes the word 'AUTO' in the display to go OFF and the overridden setting is displayed. System will remain in semiautomatic mode till 'AUTO' is pressed again.

9. Temperature control knob



Turning the temperature control knob clockwise increases the temperature of the air. The desired temperature will be increased by steps of 0.5°C. User can select temperature range from 18°C to

30°C. Turning the knob in the anticlockwise direction reduces temperature.

When you set the temperature to its lower limit (Lo) or its upper limit (Hi), the system runs at full cooling or heating only. It doesn't regulate the interior temperature.

FATC Sensors

FATC system is fitted with three sensors

1. Solar sensor is on the top of the dashboard at the right hand side of defroster grill.



2. In-car sensor on FATC control panel.



3. Outside Ambient Temperature (OAT) sensor located under the front bumper grill.

NOTE

- Do not cover or spill any liquid on sensors.
- Do not cover sensor, this may cause the sensor to malfunction. This may lead to FATC not functioning to desired level.

Xpress Cooling



This helps cabin to reach to comfort temperatures quickly by optimally setting the air conditioning to maximum cooling. Also, if required, the driver window will roll down to flush the hot air from inside the cabin. XPRESS Cooling can be turned On/Off by Fascia switch or by a soft key from Head Unit.

Functionality

Once Xpress cooling button is pressed, system optimally calculates if the car is soaked in sun and takes the driver's window roll down to flush out the hot air from cabin. Also, air conditioning system will be set to maximum cooling and maximum fan speed for short duration.

Once cabin has been sufficiently flushed, the system will announce to take driver window's roll up which can be taken up using window winding switch.

Driver side window may roll down, if:

- The cabin temperature is more than outside temperature.
- If it is not raining.
- Vehicle Speed is less than 40 kmph.

Further, after sufficiently cooling the cabin, the Xpress cooling function will auto switch off and revert back to customer pre-selected settings.

Express cooling functionality is used to improve the HVAC system performance













in case of cabin temperature being considerably greater than outside air temperature. The system will be deactivated automatically after 500 sec of continuous operation.

NOTE

The Express Cool function can only be turned ON if the Ambient temperature is above 18 degree Celsius.

CLIMATE CONTROL

Functions and Settings

Functions	Control Knob Position			Button Position			
	(2)	(7) & (9)	(1)	(3)	(4)	(5)	(6)
							
Normal heating	Desired Speed	Desired Temp.	OFF	OFF	OFF	OFF	
Quick heating	Max. speed	To the extreme right up to the stop	OFF	OFF	OFF	OFF	
Normal Cooling	Desired speed	To the right up to the desired temperature.	ON	OFF	OFF	ON	
Quick Cooling	Max speed	To the extreme left up to the stop	ON	OFF	OFF	ON	
Demisting	Desired speed	To the right up to the desired temperature	As desired	As desired	ON	As desired	As desired
Defrosting	Max speed	To the right up to the desired temperature	ON	ON	OFF	OFF	

Pre Driving Checks

Make sure that

- Windshield, windows, mirrors, lights, and reflectors are clean and unobstructed.
- Tool kit, jack & handle, warning triangle, owner's manual, first aid kit and vehicle documents are available and stored at their locations.

WARNING

Do not put any mat on the floor carpet near control pedals area.

- All doors, engine bonnet and tail gate are securely closed and latched.
- All occupants should always wear seat belts or suitable CRS as applicable while travelling.
- Objects, luggage or loads are secured correctly against slipping or tipping.
- Rear seat is securely latched.
- There is sufficient fuel for the trip.

Daily check

- Tyres for unusual wear, cracks or damage and embedded foreign material such as nails, stones, etc.
- Traces of fluid and oil below vehicle.

NOTE

Water dripping below the car is normal. This is due to the usage of air conditioning system.

- All lamps, wipers, wiper blades and horn for proper operation.
- All switches, gauges and tell tales are working properly.

Adjust:

- Seats, head restraints and steering wheel position.
- Adjust all the mirrors before you start the car.

Weekly check

- Engine oil level
- Coolant level
- Brake fluid level
- Windshield washer fluid level
- Battery electrolyte level
- Fuel level

NOTE

Tyre pressure should always be measured in cold conditions.

Do a check of the tyre pressure and condition after every 15 days, including the spare tyre.

STARTING AND DRIVING

Driving Tips

Fuel consumption, engine, transmission, brake and tyre wear are mainly affected by the below factors:

- Operating conditions of your vehicle
- Your personal driving style

Operating conditions

- Avoid frequent starts and stops as these actions increase the fuel consumption of the vehicle.
- Always ensure correct tyre pressure.
- Do not carry any unnecessary weight.
- Regularly service your vehicle and adhere to the recommended service maintenance schedule.

Personal driving style

- Do not press the accelerator pedal when starting the engine.
- Do not warm up the engine when the vehicle is stationary.
- Always adapt your driving style to suit the prevailing road, weather conditions, and maintain a safe distance from the vehicle in front. Drive carefully.
- Avoid frequent, sudden acceleration and braking.
- Select appropriate gear according to varying speeds and load conditions.

NOTE

Do not rest your foot on the clutch pedal while driving.

- Switch 'OFF' the engine in stationary traffic or at signals.
- Keep an eye on the vehicle's fuel consumption.

- Safety systems are merely aids designed to assist driving. You are responsible for the distance between the vehicles in front, for vehicle speed and anticipating braking in good time.

WARNING

- You could lose control of your vehicle if you try to adjust the driver's seat, head restraint, mirror, steering wheel and fasten the seat belt while driving. There is a risk of an accident.
- Do not rest your hand on the shift lever during driving; Pressure transmitted from your hand may result in premature wear of the transaxle internal gear shift mechanism.
- Press the clutch fully while shifting the gears. The reverse gear should be engaged only when the vehicle is stationary. Transmission may get damage by trying to shift into reverse gear

while the vehicle is moving. Wait for 5 seconds after declutching to ensure smooth engagement of the reverse gear or shift into one of the forward gears for a moment while clutch is pressed fully. This will avoid grinding of reverse gear while shifting.

Recommended fuel economy speeds

Gear	Diesel	Petrol
	Speed(kmph)	Speed(kmph)
1	20	20
2	30	30
3	45	45
4	65	65
5	80	80
6	100	100

Good driving practices

- Slow down before you shift to a lower gear. This helps the engine to keep a lower rpm and result in less wear and tear of the engine components.
- Avoid frequent brake application which can cause overheating of brakes.
- Slow down the vehicle when you drive in cross winds to get better control over the vehicle.
- Avoid high speed when cornering or turning.
- Press the clutch fully while shifting gears.
- Make sure that vehicle is completely stationary before you attempt to shift in reverse gear.
- Drive slowly on wet roads.
- You can get extra braking from the engine by shifting to a lower gear. This can help you to maintain a safe speed and prevent your brakes from

overheating specially while going down a hill.

Tips for obtaining better fuel efficiency

- Always maintain the specified tyre pressure during fuel top-ups and also before a long trip. Vehicle running with low tyre pressure will consume more fuel than the one running with specified tyre pressure.
- Keep the vehicle clean. Get rid of the unwanted stuff lying in the boot etc., to reduce weight.
- Regularly inspect your vehicle for any leakages, worn out wires by rat bites etc.
- Always follow periodic & regular service schedule of the vehicle.
- In places with high dust content (e.g.: Gurgaon, Jaisalmer etc.), Clean the air filter element at every 5000 km.
- Anticipate the road conditions and drive in a smooth manner.

STARTING AND DRIVING

- Do not accelerate excessively when you are in lower gears (1st or 2nd). Be gentle on the accelerator when you are in traffic. In lower gears, opening up the throttle will increase the engine rpm while keeping the vehicle at lower speeds. This reduces the fuel efficiency of the vehicle.
- Be in the maximum possible higher gear at a given speed. This reduces the engine operating speeds which means the engine is running at lower rpm (Revolutions per Minute) for the same vehicle speed. Lesser the number of engine revolution lesser the fuel burned.
- Avoid harsh braking.
- Maintain healthy driving habits & while decelerating, do coasting in gear and not in neutral or with clutch pedal pressed.
- Use the car AC only when you require. For cooling, keep the blower speeds low, as at higher blower

speeds, the AC consumes more electric power which is ultimately drawn from engine by burning fuel.

- Avoid unnecessary extra electrical loading on the car.
- Stop the engine wisely at traffic signals. Switch 'OFF' the engine at the traffic signal only if the stoppage time is high (typically more than 30 sec).
- When you drive on highways, close all the windows. This reduces the drag on the vehicle and improves fuel efficiency.
- Do not over speed. Follow the speed limits. With increasing speed, the engine rpm increases to overcome external air resistance and this reduces fuel efficiency.

Running-in period

The purpose of running in a car is to give time for the mechanical parts to settle so that they work efficiently. This involves gentle acceleration and not revving the engine too much. This is done by changing gears early for the first 1,500 – 1,800 km. This will increase the life of the engine.

The more you look after the engine when it is new, the more satisfied you will be with its performance in the future.

Do not exceed the following road speeds during running in period.

STARTING AND DRIVING

Gear	Diesel	Petrol
	Speed(kmph)	Speed(kmph)
1	20	20
2	35	35
3	55	55
4	75	75
5	95	95
6	120	120

Avoid heavy loads, e.g. driving at full throttle, during this period. Change gears judiciously.

NOTE

Avoid excessive revving up of engine rpm. Do not keep engine at idling for long duration.

Seat Adjustments

Front seat adjustments

Following seat adjustments can be carried out manually.



1. Backrest recliner adjustment lever
2. Seat height adjustment lever (if available)
3. Seat forward / rearward adjustment lever

WARNING

Do not adjust the driver's seat while driving. Adjusting the seat while driving could cause the driver to lose control of the vehicle.

1. Seat backrest angle adjustment

To change the seat back rest angle, lean forward slightly and pull up the lever (1). Adjust seat backrest until it reaches desired comfortable position. Make sure that lever returns to its original position and seat is securely latched.

NOTE

Adjust the seat backrest until your arms are slightly angled when holding the steering wheel.

WARNING

Do not travel in a moving vehicle with the seat backrest in an excessively reclined position as this can be dangerous.

STARTING AND DRIVING

2. Seat height adjustment (if available)

To raise the seat, pull and continue pumping the lever (2) in the upward direction until the seat is at the desired height.

To lower the seat, pump the lever downward until the seat is at desired height.

3. Seat forward/rearward adjustment

Lift lever (3) and slide the seat forwards or to the rear. Release lever and make sure that seat is securely latched.

NOTE

Adjust the driver seat position in such a way that the driver will be able to operate the control pedals comfortably.

Head restraint

Front seat



Adjust the head restraint so that it is as close to the head as possible and the center of the head restraint supports the back of the head at eye level. This will reduce the risk of injury to the head and neck in the event of an accident or similar situation.

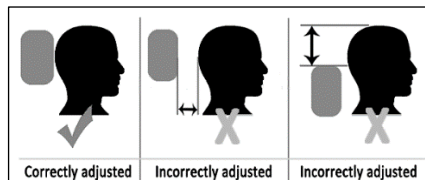

WARNING

Do not drive the vehicle without the seat head restraints. Head restraints are intended to help reduce injuries during an accident.

Front passenger seat sensor

An occupant detection sensor is installed in the front passenger seat to detect whether the seat is occupied or not. The sole purpose of this sensor is to issue seat belt reminder warnings for the front passenger seat. The sensor does not have any control on the deployment of airbags.

WARNING

Any modification in the seat material or addition of seat cover may damage or affect the performance of the sensor.

Rear seats



Rear seat folding (60:40 % Split)

You can increase the luggage capacity by folding the rear seats splits as required.

To fold the seat:



- Pull the backrest release knobs up.

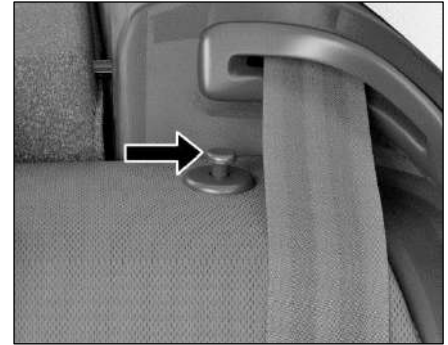

- Fold the backrest seat forward.



STARTING AND DRIVING

- Fold the backrest seat forward again. Move the driver and front passenger seat forward if necessary.



- Pull the backrest release knobs up.

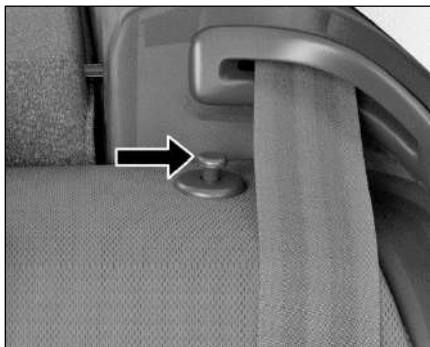

- Fold the backrest seat forward.



STARTING AND DRIVING

- Fold the backrest seat forward again. Move the driver and front passenger seat forward if necessary.



NOTE

Ensure that 'foldable arm rest' is closed before seat folding.

Rear seat folding (Complete Seat 100%)

You can increase the trunk capacity by folding the rear seat. For folding:

- Pull the backrest release knob provided on both side simultaneously.

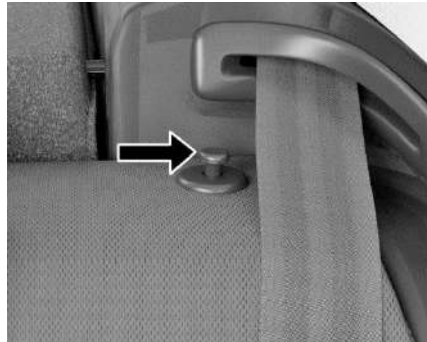

- Fold the seat backrest forwards.



WARNING

- You should always engage the rear seat if you do not need the through loading feature.
- If the rear bench seat and seat backrest are not engaged they could fold forwards, e.g. when braking suddenly or in the event of an accident.

STARTING AND DRIVING

WARNING

- The vehicle occupant would thereby be pushed into the seat belt by the rear bench seat or by the seat backrest. The seat belt can no longer offer the intended level of protection and could even cause injuries.
- Objects or loads in the trunk cannot be restrained by the seat backrest. There is an increased risk of injury.
- Before every trip, make sure that the seat backrests and the rear bench seat/rear seat are engaged and securely latched.

Luggage cover

Luggage cover is designed only for hiding the luggage compartment.

WARNING

Do not place anything on luggage cover as it could obstruct driver's rear view. Also in case of an accident or sudden braking, it could cause an injury to occupants.

Rear View Mirrors

Inside Rear View Mirror (IRVM)

To adjust the mirror move the mirror up, down or sideways manually to obtain the best rear view.

When you drive at night, set the selector tab to select anti-glare mode (if available) to reduce glare from the headlights of vehicles behind you.



NOTE

Use antiglare position only when necessary, as it reduces rear view clarity.

Outer Rear View Mirrors (ORVM)

You can adjust the outer rear view mirrors manually by Tip-Tap (By hand) or remotely by knob. Adjust the outside rear view mirrors to desired position.

NOTE

Objects visible in mirror are actually closer than they appear. Always make sure of the actual distance from the road users traveling behind by glancing over your shoulder.

Motorized ORVM adjustment (if available)



The switch to adjust the motorized mirrors is located on the driver's door. You can adjust the mirrors when the ignition switch is in the "ACC" or "ON" position.

To adjust the mirrors:

1. Move the mirror selection switch to L (for left side) and R (for right side) to select the mirror you wish to adjust.

2. Use the four positions of the knob to adjust the rear view mirrors to required position.

STARTING AND DRIVING

ORVM folding (as applicable)

Option 1: Manual folding

ORVMs can be folded or unfolded manually. This is applicable only for vehicles which are not equipped with motorized folding provision.

Option 2: Auto folding by smart key



When you lock the vehicle, ORVMs will be folded automatically.

When you unlock the vehicle, ORVMs will be unfolded automatically.

In case to repeated usage, Mirror Folding/Un-folding will stop functioning and will be re-activated after delay of 2 mins. During that period avoid repeated pressing of Switch.

Option 3: Auto folding by knob



To fold / unfold the ORVMs, keep the Selector switch in center position (i.e. neither 'L' nor 'R, position) and then toggle down. This will operate when the ignition switch is in the "ACC" or "ON" position.

Option 4: Rear view mirrors with joy stick knob

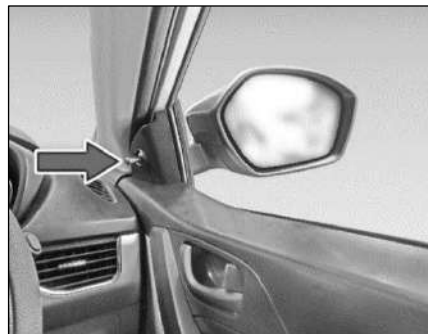

You can adjust the outer rear view mirrors manually by joy stick knob located in the driver's and front passenger's door panel.

Sun Visors

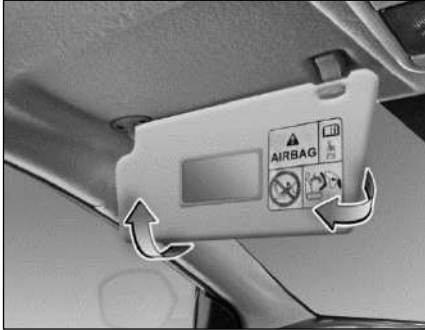

The sun visors can be pulled down to block the glare coming through the windshield.

To block the glare from side windows, pull down the sun visor and release it from retainer. Swing the sun visor to the side.

Vanity mirror (if available)

Vanity mirror is provided on the back of the front passenger side sun visor.

Electric Power Assisted Steering (EPAS)

Your vehicle is equipped with electric power assisted steering system. The EPAS system makes steering the vehicle easier with less effort.

In EPAS system, the steering effort becomes heavier as the vehicle speed increases and becomes lighter as the vehicle speed decreases for better control of the vehicle at different vehicle speeds.

If the engine is 'OFF' or if the EPAS system becomes inoperative, the vehicle still can be steered with more steering effort.

This EPAS system is available with the following assist features

1. Speed sensitive assist control
2. Active return control

NOTE

- *A click noise may be heard from the EPAS relay after the ignition switch is turned ON or OFF position.*
- *The steering wheel may not unlock normally in some cases when ignition key turned 'ON' or ISS button pressed. If this happens, turn the steering wheel to the right or left slightly to unlock the steering wheel while turning the ignition key or pressing ISS button.*
- *Contact the nearest TATA authorized service center if in case of the above scenarios.*

STARTING AND DRIVING

WARNING

Below are the symptoms of the system malfunction. Then, take your vehicle to the nearest TATA MOTORS service center and have the EPAS system checked as soon as possible.

- The EPAS warning light does not illuminate.
- Engine noise may be heard when the vehicle is driven at low speeds.
- If the EPAS system does not operate normally, the warning light  will illuminate on the instrument cluster. The steering wheel rotation may become difficult to control or operate.

Steering wheel adjustment



You can adjust the steering wheel position to suit your convenience.

The release lever is located offset to the steering column.

To adjust the steering wheel

1. Adjust the seat to a comfortable position.
2. Push “Tilt lever” completely down to unlock the steering column.

3. Adjust the steering wheel to the desired position.
4. Pull release lever up completely to lock the steering column.
5. Make sure that steering wheel is securely locked by checking up and down direction.

NOTE

When adjusting the steering wheel, make sure that:

- You can operate control pedals without any obstacles.
- You can see all the displays in the instrument cluster clearly.

WARNING

Before you start the car, make sure the steering wheel position is locked. Do not unlock or adjust the steering wheel while the vehicle is in motion.

NOTE

- The steering effort can suddenly increase, if the operation of the EPAS system is stopped to prevent serious accidents when it detects malfunction of the EPAS system during self-diagnosis.
- When steering for a prolonged period, the steering effort will increase to prevent overheating and damage to the steering system.

Steering lock and ignition switch (if available)



The ignition switch has the following four positions:

LOCK - This is the normal parking position. Key from lock can be removed in this position only.

“LOCK” position prevents normal use of the steering wheel after the key is removed.

To release the steering lock, put the key in the slot and turn it clockwise to one click (ACC).

ACC - Accessories such as the infotainment system can be operated, but the engine remains 'OFF'. Steering gets unlocked.

ON - This is the normal operating position. All electrical systems are 'ON'.

START - Turn the key further clockwise to the START position, (spring loaded) to start the engine. As soon as the engine starts, release the ignition key, which returns to ON position. While cranking, all accessories will be momentarily 'OFF'.

Illuminated Key Ring (if available)

When the vehicle is unlocked, the illuminated key ring glows. This helps to locate ignition switch in the dark.

STARTING AND DRIVING

Starting and stopping (without PEPS)

Manual Transmission (MT)

Starting the Engine

Make sure that parking brake is engaged and vehicle is in neutral gear.

Press the clutch pedal fully and crank the engine. Do not press the accelerator pedal when starting the engine.

NOTE

The Starter protection system fitted in this vehicle does not allow you to crank the engine until you fully press the clutch pedal.



Release the key as soon as the engine starts. Repeat if engine does not start.

NOTE

- *The Starter protection system switches off the starter when it is continuously cranked for more than 10 secs. In such a case, get the key back to 'OFF' position & wait for 30 secs.*

- *For vehicle equipped with turbocharger, after you start the engine, run the engine at idle speed for 30 seconds. Do not press accelerator pedal while starting the engine to avoid damage to the turbocharger.*

Starting off

To start off, press the clutch pedal fully and shift into 1st gear.

After releasing the parking brake, gradually release the clutch and slowly press the accelerator.

NOTE

When shifting or starting off, do not race the engine. Racing the engine can shorten engine life and affect smooth shifting.

Stopping the vehicle

For vehicle equipped with turbocharger, turn the key to 'ACC' position to switch off the engine. Before switching off the engine, run the engine at idle speed for

30 seconds and then switch off. This will allow the engine oil to lubricate the turbocharger, till its speed is fully reduced and also allow the unit to cool down.

WARNING

- Do not switch off the ignition while driving.
- For vehicle equipped with turbocharger, do not switch the engine off when it is running at high speed. This will lead to premature turbocharger bearing wear.
- If you switch off the ignition while driving, safety-relevant functions are only available with limitations, or not at all. This could affect the power steering and the brake boosting effect. You will require considerably more effort to steer and brake. There is a risk of an accident.

Gear Shifting and Driving



The gearshift pattern is as shown on the gear lever knob. Gear shifting should always be done with clutch pedal pressed

NOTE

- Gear recommendation is displayed when the clutch pedal is in fully released position.
- If "F" is displayed in DIS of instrument cluster, it means 'Fault' condition. Contact a TATA MOTORS Authorized Service Centre.

NOTE

- Press the clutch fully when gear shifting. The reverse gear should be engaged only when the vehicle is stationary. Wait for 5 seconds after declutching to ensure smooth engagement of the reverse gear.
- Do not press clutch pedal while driving the vehicle or when stationary on a slope.
- When vehicle is in ACC/IGN/RUN mode and user does any door state transition including tailgate and if PEPS does not detect smart key inside the vehicle when last door including tailgate is closed, then audio warning chime comes ON.

Reverse gear



For engaging reverse gear, lift the latch and keeping latch lifted, shift to reverse position.

STARTING AND DRIVING

Braking

Your vehicle has power assisted brakes.

The distance needed to bring the vehicle to a halt increases with the speed of the vehicle. Start applying brake anticipating the distance and slow down gradually.

WARNING

- Never use the brake pedal as a footrest.
- If you rest your foot on the brake pedal while driving, the braking system can overheat. This increases the stopping distance and can even cause the braking system to fail. There is a risk of an accident.
- Never press the brake pedal and the accelerator pedal at the same time.

If you have driven for a long time in heavy rain without braking, there may be a delayed reaction from the brakes when braking for the first time. This may also

occur after the vehicle has been washed.

Brake performance may become poor and unpredictable if brakes are wet.

After driving through water or washing the underside of the vehicle, test the brakes while driving at a slow speed to see if they have maintained their normal effectiveness. If the brakes are less effective than normal, dry them by repeatedly applying the brakes while driving slowly until the brakes have regained their normal effectiveness.

Braking on downhill gradients

On long and steep gradients, you must reduce the load on the brakes by shifting early to a lower gear. This allows you to take advantage of the engine braking effect and helps avoid overheating and excessive wear of the brakes.

WARNING

- Do not shift to lower gear on a slippery road surface in an attempt to increase the engine's braking effect, the drive wheels could lose their grip.
- There is an increased danger of skidding and accidents.

Automated Manual Transmission (AMT) (If fitted)



Gear Shift Lever

Transmission (AMT) Gearbox offers a choice of three driving modes:

1. Automated mode with the gear lever in position 'A'
2. Manual mode with the gear lever in position 'M'.

Starting

- a. Engage the parking brake firmly. Press Brake pedal.

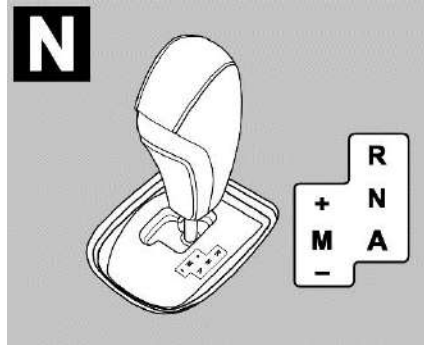

- b. Put the ignition 'ON'
- c. While the brake pedal is pressed, bring the shifter lever to Neutral - 'N'. Check 'N' on instrument cluster.

Crank to start the engine with the brake pedal still pressed.

NOTE

If push button is pressed with brake pedal is pressed and gear is in A mode, the vehicle will not start. It will

start within 10 seconds if gear shifter is moved from A to N with the brake pedal continuously pressed.”.

Stopping

The vehicle can be stopped by depressing the brake pedal regardless of the gear position. This is because the clutch is automatically disengaged to prevent the engine from stalling.

If the gearshift lever is in the 'A' position, the gear will be downshifted to '1st' when the vehicle stops. Also, if the gearshift lever is in the 'M' position, the gear will be downshifted to '1st' when the vehicle stops.

NOTE

'Auto' mode will give optimum engine Torque and Power output. Drive the vehicle in 'Auto' mode to get max fuel economy.

Exhaust fan in the engine compartment will remain 'ON' for a short while after IGN is switched 'OFF'.

STARTING AND DRIVING

Gear shifter driving Modes

Neutral

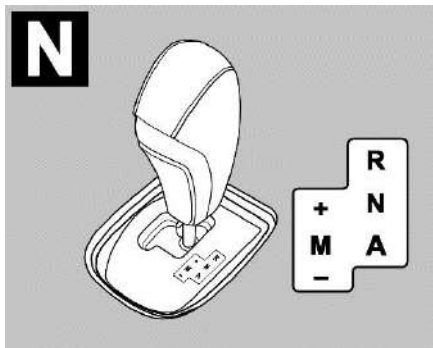

Vehicle is in neutral gear position. This will be indicated **N** on instrument cluster.

WARNING

- Always make sure to keep the gear shift lever in the “N” position, when the engine is running and vehicle is stationary.
- Do not shift the lever in “N” position, even momentarily, when the vehicle is in motion.

Reverse

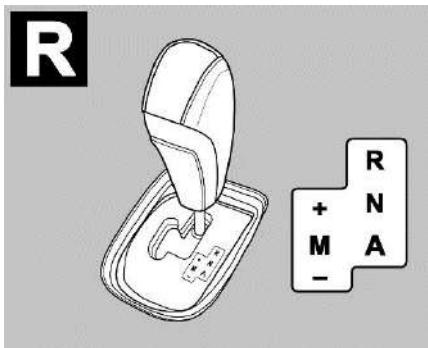

Reverse gear will be engaged only when vehicle is stationary and brake pedal pressed. An audio signal indicates when reverse gear is engaged. **R** will be indicated on instrument cluster.

Auto Mode

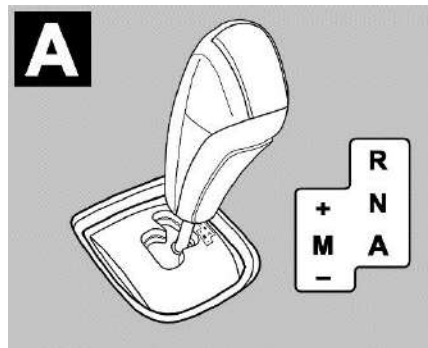

Auto mode will be engaged only when vehicle is stationary and brake pedal pressed. An audio signal indicates when Automatic gear is engaged. **A** will be indicated in instrument cluster.

Gear Upshift and Downshift will be done automatically while driving.

Manual Mode:

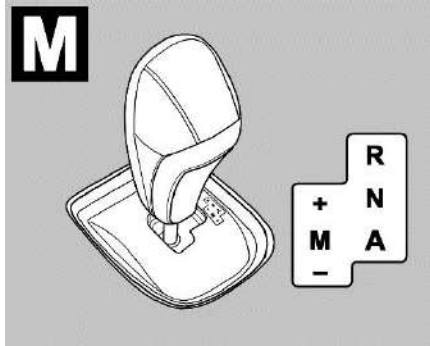

Shift gear lever to left for engaging manual mode. An audio signal indicates when manual mode is engaged. **M** will be indicated in instrument cluster.

In manual mode, driver should select the desired gear by shifting lever to,

- + Upshift the gears.
- Downshift the gears.

Push the gearshift lever to the '+' direction and release it. Every time the lever

is operated, upshifting takes place 1 step in the order of 1st → 2nd → 3rd → 4th → 5th → 6th gear.

Pull the gearshift lever to the '-' direction and release it. Every time the lever is operated, downshifting takes place in the order → 6th 5th → 4th → 3rd → 2nd → 1st gear.

NOTE

Down shifting of gear occurs automatically while braking/engine rpm reduction.

In manual mode, gears are not shifted automatically unless the engine RPM threshold is reached.

Creeping feature

Creeping function allows the car movement without accelerator Pedal pressed when the brake pedal is released.

This functionality is generally used in parking maneuvers, with 1st or 'R' gear engaged, in this situations the driver enters and exits from creeping just by pressing the Acc. pedal.

NOTE

Creeping function will not operate when vehicle is in standstill condition on inclined surface.

- Creep feature is enabled for Manual as well as Auto Mode for first and reverse gear.
- After vehicle cranking and brake pedal released vehicle starts moving without pressing accelerator Pedal.
- Whenever accelerator pedal is pressed creep function will be disabled.
- Whenever driver door is opened and / or parking brake is engaged, creep function will be disabled.

STARTING AND DRIVING

Kick down feature

In Automatic mode, while driving at a constant speed if the accelerator pedal is quickly pressed the AMT downshifts the gear (if required). It ensures optimum acceleration to complete overtaking in minimal time.

Driving

- a. With the engine running and brake pedal pressed, depending on your requirement shift the lever on R, D or M. Check the position engaged on the Instrument Cluster display.
- b. Release the parking brake.
- c. Release the brake pedal and press the accelerator pedal gently.

NOTE

Use right foot only to operate brake or accelerator pedal.

Do not operate accelerator and brake pedal simultaneously.

Do not use your left leg to operate the pedals while driving AMT vehicle.

NOTE

*If **F** displayed on the Instrument Cluster display, it means 'Fault condition. Contact a TATA MOTORS Authorized Service Centre immediately.*

Parking

AMT does not have a parking position. The vehicle can be parked with the gearshift lever in any position.

1. Apply the parking brake firmly.
2. Press the brake pedal and shift the gearshift lever to the 'R' position on a downhill slope, or to the Auto 'A' mode or the 'M' position in the manual 'M' mode on an uphill slope or flat road and confirm the gear position by checking the gear position indicator on instrument cluster. Gear engagement (R or A) can be done with ignition ON/engine running condition only.
3. Turn the key to 'ACC' position to switch off the engine. Before switching off the engine, run the engine in idle condition for at least 30 seconds and then switch off. This will allow the engine oil to lubricate the turbocharger, till its speed is fully reduced and also allow the unit to cool down.

WARNING

A quick burst on the accelerator before turning off the engine serves absolutely no practical purpose, it wastes fuel and is damaging especially to turbocharged engine.

WARNING

Do not switch the engine off when it is running at high speed. This will lead to premature turbocharger bearing wear.

NOTE

The AMT vehicle will shift itself into Neutral as a precautionary measure, if the vehicle is stationary and one or both of the front wheels spin on a low friction surface (e.g. Snow, mud, soft sand etc). AMT symbol will glow in the instrument cluster indicating an intervention from the Transmission Control Unit.

Following steps need to be carried out sequentially in order to manoeuvre the vehicle in such a situation.

- 1. Shift the gear shift lever to Neutral position and switch the ignition off.*
- 2. Press the brake pedal and crank the engine again.*
- 3. With the engine running, shift the gear position in Auto mode.*
- 4. March the vehicle with low input from the accelerator pedal as this will ensure that the wheels do not spin.*

Driving (MT)

Climbing Sharp Gradients on Loose Surfaces

Start off smoothly in a suitable gear. Accelerate smoothly so that there is no loss of traction by over-revving of the engine.

Choose as smooth a slope as possible and select the appropriate gear so that gear changing in the middle of the climb is not required.

Changing gears in the middle of the climb can cause loss of momentum and engine stalling. Shifting to lower gear has to be done cautiously to avoid loss of traction.

Under no conditions should the vehicle be moved diagonally across a hill. The danger is in loss of traction and sideways slippage, possibly resulting in toppling over. If unavoidable, choose as mild an angle as possible and keep the vehicle moving.

If the wheels start to slip within few feet of the end of the climb, motion can be maintained by swinging the steered wheels left and right, thereby providing increased grip.

If the vehicle stalls or losses headway while climbing a steep hill, make a quick shift to reverse and allow the vehicle to move back with the control of engine compression.

STARTING AND DRIVING

Descending Sharp Gradients

Depending on the severity of the gradient, shift into appropriate gear. Use engine braking judiciously without over-revving the engine.

Brake application under such situations should be done very.

WARNING

When descending on sharp gradients, NEVER turn the ignition key to the 'OFF' position. Emission control system damage may result.

NOTE

The engine can only be started when the gearshift lever is in "N" position with the brake pedal firmly pressed.

Driving (AMT)

Climbing Sharp Gradients

Apply the parking brake firmly so that the vehicle does not roll backwards.

Shift the gearshift lever to the "A" position while depressing the brake pedal. Make sure that the gear position indicator in the instrument cluster displays '1st' gear.

Release the brake pedal and depress the accelerator pedal gradually, and when the vehicle starts to move, release the parking brake and depress the accelerator pedal to start off.

On climbing sharp gradients, never hold the vehicle at a stop using only the accelerator pedal or the creeping function. If you perform this operation for a certain period of time, this can also cause excessive damage to the clutch.

WARNING

Try not to hold the brake pedal down too long or too often while going down a steep or long hill.

This could cause the brakes to overheat, resulting in reduced braking efficiency. Failure to take this precaution could result in loss of vehicle control.

Descending Sharp Gradients

Depress the brake pedal and shift the gear shift lever to the 'A' position. Make sure that the gear position indicator in the instrumental cluster displays '1st' gear.

Release the brake pedal and depress the accelerator pedal slowly. Even if the accelerator pedal is not depressed, the clutch will be engaged when the vehicle speed increases.

WARNING

When descending on sharp gradients, NEVER turn the ignition key to the 'OFF' position. Emission control system damage may result.

Starting and stopping (PEPS) (if available)

Engine Passive Start/Stop



Start/Stop switch is provided on the dashboard towards the left side of steering wheel.

Start/Stop button

The start/stop button or Push to Start Button is a main component of Passive (Engine) Start and Stop system. It is used to control ACC, IGN outputs as well as to start and stop the engine.

NOTE

- If smart key is inside the vehicle and on pressing start stop switch, if start stop switch green LED blinks more than 10 sec. duration then contact authorized TATA MOTORS dealer.
- If ESCL (Electronic Column Steering Lock) is not unlocked properly, then vehicle doesn't go into ACC mode

Backup start:

To start the engine when smart key battery voltage is low, the user needs to press start/stop button two times with an interval of 2.5 seconds after pressing the clutch with valid smart key near immobilizer antenna (in Centre Console below Tambour door).



Emergency start:

If the engine is switched from ON to OFF and start/stop button is pressed with clutch pressed within 5 seconds, engine gets cranked.

NOTE

If ESCL (Electronic Column Steering Lock) is not unlocked properly, then Engine will not get cranked.

STARTING AND DRIVING

Engine Passive Start - conditions

- **Single Press Start:**

1. Bring the smart key with you and sit in the driver seat.
2. Press the clutch pedal and then press the start/stop switch.
3. Green colour LED on start/stop button will turn ON.
4. Once engine is started successfully, the green colour LED on start/stop button stays ON.

- **Two Step Start:**

a) Step 1

1. Have the smart key with you and sit on the driver's seat.
2. Press the start/stop button without pressing clutch pedal.
3. Amber colour LED on start/stop switch turns ON.
4. Engine will remain OFF and all electrical equipment and infotainment

system can be used. Steering is unlocked.

b) Step 2

1. Press the clutch pedal and then press start/stop button to start the engine.
2. Green colour LED on start/stop button will turn ON.
3. Once engine start successfully, green colour LED on start/stop switch will remain ON.

- **Three Step Start:**

a) Step 1

1. Have the smart key with you and sit on the driver's seat.
2. Press the start/stop button without pressing clutch pedal.
3. Amber colour LED on start/stop button will turn ON.
4. Limited information will be displayed on instrument cluster and steering

will be unlocked. Engine remains OFF.

b) Step 2

1. Press the start/stop button without pressing clutch pedal again.
2. Green colour LED on start/stop button will turn ON.
3. Engine will remain OFF but all electrical equipment and infotainment system can be used.

c) Step 3

1. Press the clutch pedal and then press start/stop button to start the engine.
2. Green colour LED on start/stop button will turn ON.
3. Once the engine is started successfully, the green colour LED on start/stop button stays ON.

Engine Passive Stop - conditions

1. Single Press Stop:

- IGN is ON and engine is running.

- Press the start/stop button with or without clutch.
- ACC and IGN turns OFF.
- LED on start/stop switch turns OFF.

2. Single Long Press Stop:

- IGN is ON and engine is running.
- Vehicle is in running condition i.e. wheel rpm >10 RPM or wheel sensor faulty.
- Press the start/stop button for more than three seconds.
- IGN returns OFF, ACC remains ON.
- Amber colour LED on start/stop switch turns ON.

WARNING

When vehicle is in OFF mode (ACC, IGN and Crank OFF) and user tries to lock the vehicle from outside by pressing any door handle switch and if PEPS detects that the smart key is left inside the vehicle, an audio warning/ chime is sounded.

PEPS - Wearable Key (if available)

- You can wear it on his/her wrist and drive the car (ease of carrying and usage)
- The key fob performs dual functions of passive entry/exit and passive start (similar functions of UID).
- Wearable device will work with PEPS vehicle only and it is an add-on device along with the smart key.

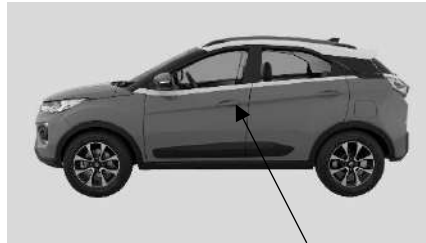

UID (Smart Key)



Wearable Key

PEPS Features

(a) Passive Entry

Entry in Vehicle through Driver Door:

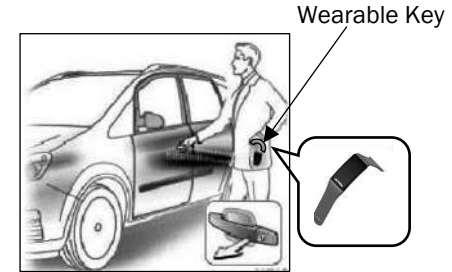

Press driver door handle button along with valid wearable key fob within the authentication range of 1.2 m.

STARTING AND DRIVING

Tailgate opening of vehicle:

- Press tailgate handle button along with valid wearable key fob within the authentication range of 1.2 m.



Tailgate switch

(b) Passive exit

Exit from Vehicle through Driver Door

- Stop the car and turn off the ignition.
- Come out of the vehicle and close the door.

- Press the driver door handle button along with valid wearable key fob within the authentication range of 1.2 m.
- Vehicle get locked.

Engine Passive Start – conditions



• Single Press Start:

1. Bring the smart key with you and sit in the driver seat.
2. Press the clutch pedal and then press the start/stop switch.

3. Green colour LED on start/stop button will turn ON.
4. Once engine is started successfully, the green colour LED on start/stop button stays ON.

• Two Step Start:

a) Step 1

1. Have the smart key with you and sit on the driver's seat.
2. Press the start/stop button without pressing clutch pedal.
3. Amber colour LED on start/stop switch turns ON.
4. Engine will remain OFF and all electrical equipment and infotainment system can be used. Steering is unlocked.

b) Step 2

1. Press the clutch pedal and then press start/stop button to start the engine.

STARTING AND DRIVING

- Green colour LED on start/stop button will turn ON.
- Once engine start successfully, green colour LED on start/stop switch will remain ON.
- Green colour LED on start/stop button will turn ON.
- Engine will remain OFF but all electrical equipment and infotainment system can be used.

Three Step Start:

a) Step 1

- Have the smart key with you and sit on the driver's seat.
- Press the start/stop button without pressing clutch pedal.
- Amber colour LED on start/stop button will turn ON.
- Limited information will be displayed on instrument cluster and steering will be unlocked. Engine remains OFF.

b) Step 2

- Press the start/stop button without pressing clutch pedal again.

c) Step 3

- Press the clutch pedal and then press start/stop button to start the engine.
- Green colour LED on start/stop button will turn ON.
- Once the engine is started successfully, the green colour LED on start/stop button stays ON.

Backup Start

- If wearable key fob's battery is low or drained, kindly refer the battery replacement procedure of key fob in maintenance section. Customer should always carry the key fob along with wearable key.

- In this condition, customer has to keep the key fob in center console antenna (refer below image).

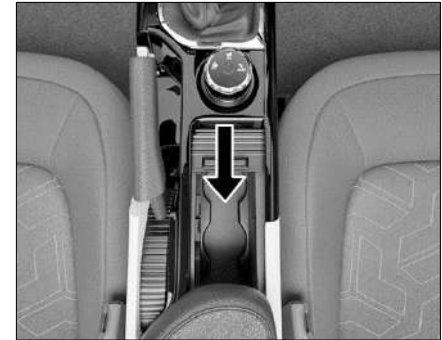

In Centre Console below Tambour door.

- To start the engine when the wearable key fob's battery voltage is low or empty, user needs to press start/stop button two times with interval of 2.5 seconds along with the clutch. Engine will get cranked.

STARTING AND DRIVING

Engine Passive Stop - conditions

1. Single Press Stop:

- IGN is ON and engine is running.
- Press the start/stop button with or without clutch.
- ACC and IGN turns OFF.
- LED on start/stop switch turns OFF.

2. Single Long Press Stop:

- IGN is ON and engine is running.
- Vehicle is in running condition i.e. wheel rpm >10 RPM or wheel sensor faulty.
- Press the start/stop button for more than three seconds.
- IGN returns OFF, ACC remains ON.
- Amber colour LED on start/stop switch turns ON.

WARNING

When vehicle is in OFF mode (ACC, IGN and Crank OFF) and user tries to lock the vehicle from outside by pressing any door handle switch and if PEPS detects that the smart key is left inside the vehicle, an audio warning/ chime is sounded.

Gear Shifting



The gearshift pattern is as shown on the gear lever knob. Gear shifting should always be done with the clutch pedal fully pressed.

NOTE

- Gear recommendation is displayed when the clutch pedal is fully released.
- If "F" is displayed in DIS of instrument cluster, it means 'Fault'

condition. Contact TATA MOTORS Authorized Dealer/Service Center.

- Press the clutch fully when gear shifting. The reverse gear should be engaged only when the vehicle is stationary.
- Use the clutch only to shift gears and do not use it when vehicle is stationary on a slope, as the car will roll down due to gravity.
- If all doors are closed when the vehicle is in ACC/IGN/RUN mode and if PEPS does not detect the smart key inside the car, then an audio warning is given.
- Do not rest your hand on the shift lever during driving; Pressure transmitted from your hand may result in premature wear of the transaxle internal gear shift mechanism

Reverse gear

To engage reverse gear, lift the latch and keeping latch lifted, shift to reverse position.



Driving

Climbing Sharp Gradients on Loose Surfaces

Start off smoothly in a suitable gear. Accelerate smoothly so that there is no loss of traction by over-revving of the engine.

Choose a smooth slope and select the appropriate gear so that gear changing in the middle of the climb is not required.

Changing gears in the middle of the climb can cause loss of momentum and engine stalling. Shifting to lower gear has to be done cautiously to avoid loss of traction.

Under no conditions should the vehicle be moved diagonally across a hill. The danger is in loss of traction and sideways slippage, possibly resulting in toppling over. If unavoidable, choose a mild angle and keep the vehicle moving.

STARTING AND DRIVING

If the tyres start to slip within few feet at the end of the climb, keep the vehicle stable by steering left and right. It gives increased grip to the tyres.

If the vehicle stalls or losses headway while climbing a steep hill, make a quick shift to reverse and allow the vehicle to move back with the help of engine braking.

Descending Sharp Gradients

Depending on the severity of the gradient, shift into appropriate gear. Use engine braking judiciously without over-revving the engine.

Brake gently in such situations.

WARNING

When descending on sharp gradients, do not turn the ignition key to the 'OFF' position. The braking assist and steering assist may malfunction and the emission control system may be damaged.

Braking

Your vehicle has vacuum assisted brakes.

The distance needed to bring the vehicle to a halt increases with the speed of the vehicle. Start applying brake anticipating the distance and slow down gradually.

WARNING

- Do not use the brake pedal as a footrest.
- If you rest your foot on the brake pedal while driving, the braking system can overheat and cause fading of brake pads. This increases the stopping distance and can even cause the braking system to fail. There is a risk of an accident.
- Do not press the brake pedal and the accelerator pedal at the same time.

If you have driven for a long time in heavy rain without braking, there may be

a delayed reaction from the brakes when you brake for the first time. This may also occur after the vehicle has been washed.

Brake performance may become poor and unpredictable if brakes are wet.

After you drive through water or if you wash the underside of the vehicle, test the brakes at slow speeds to see if the brakes work fine. If the brakes are less effective than normal, dry them by repeatedly applying the brakes at slow speeds until the brakes have regained their normal effectiveness.

Check traffic conditions before doing the above activity.

Braking on downhill gradients

When you drive on downhill slopes, reduce the load on the brakes by shifting to a lower gear. This is called as engine braking and aids to reduce overheating and wear of brakes.

WARNING

- Do not shift to lower gears on a slippery road surface to increase the engine's braking effect. By doing so, the tyres could lose their grip.
- There is an increased danger of skidding and accidents.



Drive Mode



Drive mode selection switch

'ECO', 'CITY' and 'SPORT' drive modes are provided. These modes can be used to adjust engine characteristics and vehicle performance in line with desired requirement.

Drive mode selection switch is provided on center console for activation

Drive Mode	Performance
 CITY	Increased engine Torque and Power output for BALANCED performance
 ECO	Optimum engine Torque and Power output for FUEL EFFICIENT performance
 SPORT	Driver can use maximum torque from engine.

Current gear indication

The Driver Information display (DIS) in the Instrument Cluster indicates the current gear position engaged. 

Gear recommendation

Up or down arrow will be displayed in DIS, recommending whenever gear should be shifted to up or down.



STARTING AND DRIVING

Parking Brake

Mechanical parking brake acting on the rear wheels is provided on the vehicle.



Parking brake applied

To apply the parking brake, pull the lever up fully. The parking brakes' tell-tale light comes on in the instrument cluster.



Parking brake released

To release it, pull the lever up slightly (1), press the release button (2) and push the lever down (3). Parking brakes tell-tale on the instrument cluster will turn 'OFF' when the lever is fully released.

NOTE

Apply the parking brake properly before leaving the vehicle and release it before moving.

Vehicle parking

- Park the vehicle in a safe place. Switch on the indicator signal before turning to park.
- Apply the parking brake.
- Make sure that all window glasses are closed and all lamps are turned 'OFF'.
- At night, put on the parking lights if required.
- Remove the key from the ignition switch and lock the vehicle.
- Use wheel chocks if the vehicle is parked on a slope.

NOTE

When parking on a downhill gradient, place the gear lever in 'Reverse' position. While parking on uphill gradient, place the gear lever in the '1st' position.

STARTING AND DRIVING

WARNING

Never leave children unsupervised in the parked vehicle. They could also operate the vehicle's equipment. There is a risk of an accident and injury.

NOTE

Do not use parking brake for braking unless unavoidable circumstances like when service brake is not working properly. The braking distance is considerably longer and the wheels could lock. There is an increased danger of skidding and accidents.

Reverse Park Assist with sensor (if available)

Reverse Park Assist system is an electronic parking aid that will assist you to park your vehicle safely when in reverse gear mode. It provides audio and visual information through the vehicle's infotainment system. The reverse park assist system can also be activated manually through infotainment screen.

Always look out for kids, pets and elderly people behind the vehicle before reversing.



There are ultrasonic sensors placed in on the rear bumper. Number of sensors may vary depending on the variant.

Once the system is activated, the sensors will detect how near the obstacle is from the bumper, and this information is would be displayed on the vehicle's infotainment system. In base variants, only audio warning shall be given through a buzzer.

WARNING

Due to ultrasonic sensor technology limitation, detection of obstacles from 0-25 cm is not guaranteed.

STARTING AND DRIVING

Approximate distance from Bumper (in cm)	Visual Information	Audible Information
25 – 40	All six zones are highlighted (Red, Green and Yellow zones)	Continuous Beep
41 – 80	Bottom four zones are highlighted (Yellow and Green zones)	Fast Beep
81 – 120	Bottom two zones are highlighted (Green zones)	Slow Beep

Variant where infotainment display is not present and audio warning is given through a buzzer, on activating the Reverse Park Assist system, a tone will be played within first two seconds to indicate the proper functioning of the system. After these two seconds, normal functioning of the system will continue. If no tone is heard for first two seconds, it shall mean that RPAS system is faulty. The owner should, in that case, go to the nearest dealer for rectification.

Park assist indications

In case reverse park assist system malfunctions, fault message may appear on the infotainment screen.

Reason for this fault may be

- Park Assist Controller / Body Control Module Failure"
- Sensor Malfunction
- Partner components such as Infotainment music system, Instrument Cluster failure.



Reverse park assist limitations

Reverse Park Assist system is not a collision avoiding system. It is solely the driver's responsibility to park the vehicle safely.

Reverse Park Assist feature works on ultra sound echo technology, due to which performance is not guaranteed in following scenarios:

- If the object has a sharp edge surface, where surface may divert echoes from sensor reception.
- If object is mesh fence made up of thin wires, where echoes can't be given by the surface.
- Fast moving objects passes in the sensor's field of detection, where echoes are not processed by the system.
- If object is made/covered by foam or sponge or snow where ultrasonic sound signals are absorbed.
- Objects close to the rear bumper can go undetected by the Reverse Park Assist's field of detection. Driver should use extreme caution while parking the vehicle.
- If height of the bumper is changed due to alteration to the suspension or other causes
- If the sensor areas are extremely hot from direct sunlight or cold due to freezing weather.
- If Sensors are covered by a hand, sticker, accessory, etc.
- If ultrasonic noise is present around Vehicle due to other vehicle sensors, horn, engine, air braking system (large vehicles), Exhaust Fans, Wireless transmitters or mobile phones
- If the vehicle speed exceeds 10kmph, the system will not warn you even though objects are detected, error message 'Vehicle Speed is high, drive slowly!' will appear.
- Driving on uneven road surfaces e.g. Gravel, unpaved roads, Artificial Speed Breakers, or gradient.
- Poles of square/rectangular cross section might not be detected due to the ultrasonic technology limitation.

WARNING

Due to any reason, if the sensor gets misaligned or loses its intended fitment position, contact your dealer for refitment.

NOTE

Turning the ignition 'OFF' 'while the park assist feature is active would disable it.

STARTING AND DRIVING

Reverse park assist system preventive maintenance

- Regularly clean the Sensors/camera* (*if available) and keep them free from dust, ice, mud, water, chewing gum etc. for proper working of the system. Use a smooth cloth for cleaning.
- Do not use water at high pressure for cleaning the sensor or camera.
- Do not cover the Sensors/camera* (*if equipped) surface with any additional fitment. This will interrupt park assist performance.
- Do not remove mud, snow on the sensors using stick or hard material. Use normal water and soft cloth.

General Warning

1. In low light conditions, the screen may darken or image may appear faint.
2. If the tire sizes are changed, the position of the fixed guidelines displayed on the screen may change.
3. In case of damage of the rear portion of the vehicle, Reverse Park Assist sensors position may change which causes wrong visual information on display. In case of damage make sure that Reverse Park Assist sensors are fitted properly at the intended location.
4. In case of uneven road conditions or up-hill or downhill conditions, do not depend on Reverse Park Assist aid.
5. Do not apply any kind of force on the reverse park assist sensors.
6. Always use rear view mirrors along with Reverse Park Assist for confirming the safety of the rear and the surrounding conditions.

Rear View Camera (if available)



Rear View Camera is a visual reverse guiding system. When reversing or parking, make sure that there are no persons, animals or objects in the area where you are reversing.

The display will be shown on the infotainment screen.

STARTING AND DRIVING



Display screen

Activation

Reverse gear

This system will start, if reverse gear is engaged, or park assist button (if available) is pressed or manual activation is done through Infotainment screen.

Deactivation

System will stop, if reverse gear is disengaged, or park assist button (if available) is pressed.

If started through infotainment, the system can be stopped using a cross button on infotainment screen.

Understanding Guidelines Indication



Green Line

You can safely reverse the vehicle, but be cautious if objects fall in this zone.

Yellow Line

You have to take utmost care if objects fall in this zone. However, the objects may not hit vehicle.

Red Line

Red line indicates that you have to stop reversing the vehicle. If you still go backwards, the car will hit the obstacle.

STARTING AND DRIVING

Do's and don't

- Do not use camera when tailgate is open. If tailgate is open, visual information may not be the actual rear view of the vehicle & system will warn with message 'Tail Gate Open, Please close.
- When the camera is operated under fluorescent lights, sodium light or mercury light etc., illuminated areas on the lens may appear to flicker in the display.
- Do not attach any advertisement or styling or any kind of stickers on top of camera. If this happens, camera cannot provide you the visual image and it may damage the camera.
- Do not add any accessory, which will cause blockage to the camera's field of view.

Cleaning camera

1. Due to environmental reasons, dust, mud or fog may accumulate on the camera lens. So regularly clean the camera lens.
2. Use water to clean the camera lens. Do not use extreme cold or hot water. Rapid changes in temperature may brittle the camera lens. Do not apply High Pressure water for cleaning.
3. Wipe the camera lens with soft cloth.
4. Do not use hard cloth or material to wipe the camera lens. This will cause scratches on the camera, and leads to deteriorated visual image on the display.
5. Do not apply organic solvent, car wax, window cleaner or glass coat to clean the camera. If this is applied, wipe it off as soon as possible.
6. Do not apply heavy force on lens, while cleaning.

7. Do not remove mud, snow on the camera lens using stick or hard material. Use normal water and soft cloth.

WARNING

- The camera uses fish eye lens. So the size of the objects or in the display may differ from the actual size and distance. In low light conditions, the screen may darken or image may appear faint.
- If the tire sizes are changed, the position of the fixed guidelines displayed on the screen may change.
- During rainy conditions, image may get obscured. In such conditions, do not depend on camera view. The camera used in the vehicle, may not reproduce the same color of the real object.

STARTING AND DRIVING

- In case of damage of the rear portion of the vehicle, camera position may change. Which causes wrong visual information on display. In case of damage, make sure that, camera is fitted properly at the intended location.
- In case of uneven road conditions or up-hill or downhill conditions, do not depend on rear view camera park aid.
- Do not apply any kind of force on the camera.
- Always use rear View mirrors along with Rear View Camera for confirming the safety of the rear and the surrounding conditions.
- High humidity and variation in ambient temperature may result into condensation inside the camera lens, which may further result into degradation of camera video feed on the screen. It is recommended that not to rely on

camera video feed for parking assistance in such scenario. This phenomenon is temporary and will be automatically recovered with reduction in humidity and less variation in ambient temperature.

- The area displayed by the rear view camera is limited. The camera does not display objects that are close to or below the bumper, underneath the vehicle, or objects out of the camera's field of view. The area displayed on the screen may vary according to vehicle orientation or road conditions.

Rear view camera system precautions

1. Area displayed on screen

The rear view camera system displays an image of the view from the bumper of the rear area of the vehicle.

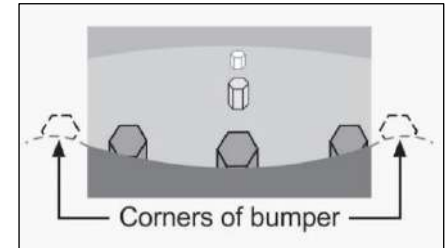
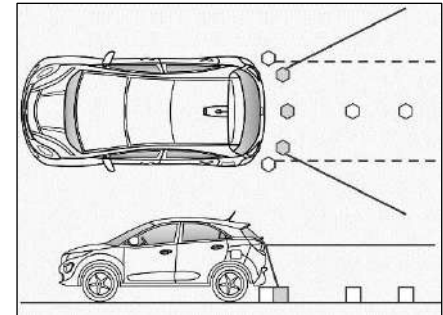

STARTING AND DRIVING

- The area displayed on the screen may vary according to vehicle orientation conditions.
- Objects, which are close to either corner of the bumper or under the bumper, cannot be seen on the screen.
- The camera uses a special lens. The distance of the image that appears on the screen differs from the actual distance. The camera may not display items that are located higher than the camera's field of view.

2. When sharp up gradient behind the vehicle

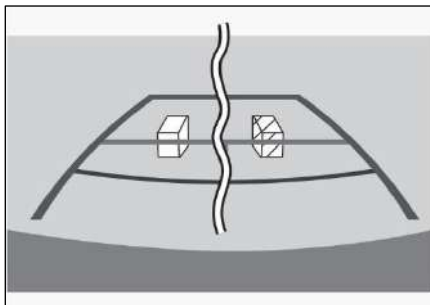
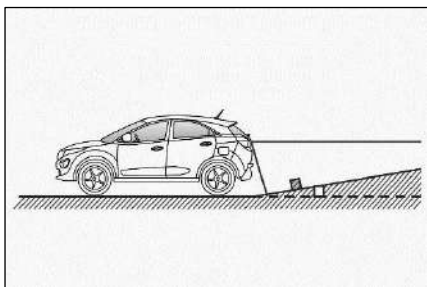

The distance guidelines will appear to be closer to the vehicle than the actual distance.

Because of this, objects will appear to be farther away than they actually are.

In the same way, there will be a margin of error between the guidelines and the actual distance/course on the road.

3. When sharp down gradient behind the vehicle

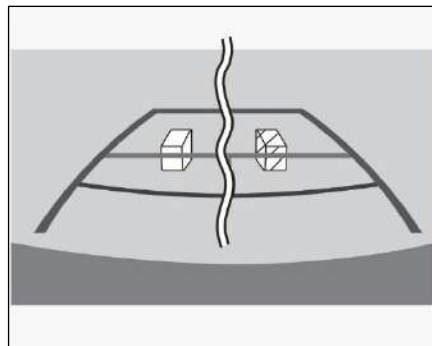
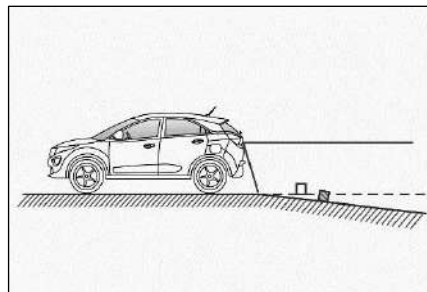

NOTE

The distance guidelines will appear to be further from the vehicle than the actual distance.

Because of this, objects will appear to be closer than they actually are. In the same way, there will be a margin of error between the guidelines and the actual distance/course on the road.

4. When any part of the vehicle sags

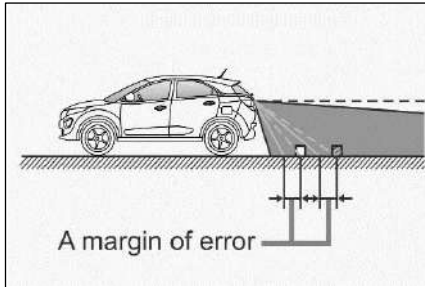

When any part of the vehicle sags due to the number of passengers or the distribution of the load, there is a margin of error

error between the fixed guide lines on the screen and the actual distance/course on the road.

5. When approaching three-dimensional objects

The distance guidelines are displayed according to flat surfaced objects (such as the road). It is not possible to determine the position of three-dimensional objects (such as vehicles) using the distance guidelines. When approaching a three-dimensional object.

a. Distance guidelines

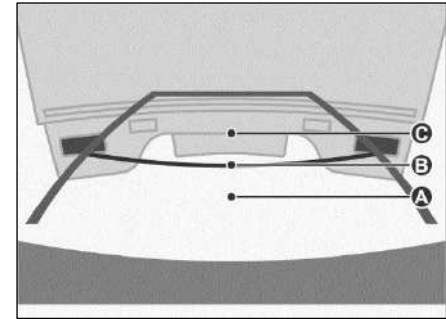
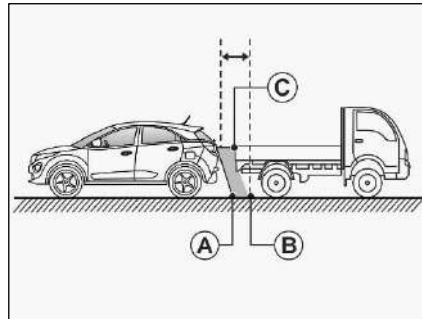

Visually check the surroundings and the area behind the vehicle. On the screen, it appears that a truck is parked at point B. However, in reality if you back up to point A, you will hit the truck. On the screen, it appears that A is closest and C is furthest away. However, in reality, the distance to A and C is the same, and B is further away from A and C.

STARTING AND DRIVING

b. Vehicle width guidelines

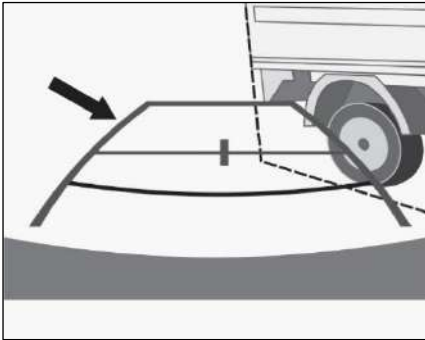
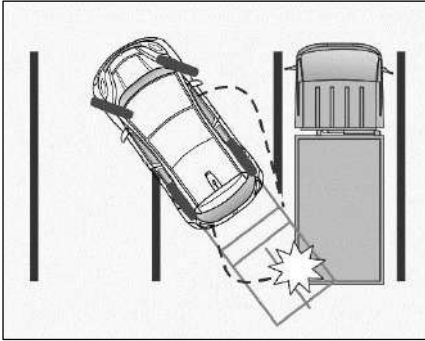

Visually check the surroundings and the area behind the vehicle. In the case shown below, the truck appears to be outside of the vehicle width guidelines and the vehicle does not look as if it hits the truck. However, the rear body of the truck may actually cross over the vehicle width guidelines. In reality if you back up as guided by the vehicle width guidelines, the vehicle may hit the truck.

EMERGENCY AND BREAKDOWN ASSISTANCE

Emergency Equipment

You should be familiar with the location of the emergency equipment provided in the vehicle and how to use it.

Do a check of this equipment periodically and make sure that they are in proper working condition and stowed at their locations.

First aid kit

The first aid kit is kept inside the glove box compartment.

The kit contains items that can be used in case of minor injuries only.

NOTE

Examine contents of the first aid kit periodically and replenish consumed or expired items.

Tool kit, tow hook, jack and spare wheel

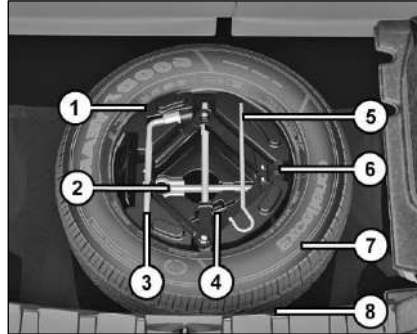

Following parts are provided as part of toolkit in the rear boot.

1. Tool tray
2. Tow hook
3. Wheel Spanner
4. Spanner 8 x10
5. Jack Handle
6. Jack
7. Spare wheel
8. Advance warning triangle

NOTE

The jack should be used only to change wheels. It is important to read the instructions in this section before attempting to use the jack.

EMERGENCY AND BREAKDOWN ASSISTANCE

Advance Warning Triangle

An advance warning triangle is kept in the luggage compartment beside spare wheel.

Use advance warning triangle to warn the approaching traffic in case of vehicle break-down or during emergency, where



your vehicle could become a potential traffic hazard.

When you press the hazard warning switch, all turn signal lamps will start to blink.

Keep the warning triangle at an approximate distance of 50-150 m behind your vehicle in the same lane of traffic. The reflecting side of the triangle should face the oncoming traffic and it should be free from any obstacles.

Remove the advance warning triangle carefully from the bag and assemble. Refer instructions given on the bag.

NOTE

After using the warning triangle tie it firmly and keep it inside the bag to avoid rattling noise.

Hazard Warning Switch

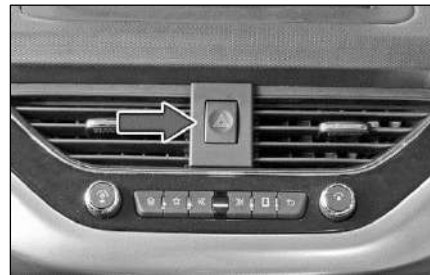

Press the hazard warning switch to activate the hazard warning. All the turn signal lamps will flash simultaneously. To turn OFF, press the switch again.

Use the hazard warning to warn the traffic during emergency parking or when your vehicle could otherwise become a traffic hazard.

The hazard warning lamps can operate even if the ignition is switched off.

EMERGENCY AND BREAKDOWN ASSISTANCE

Spare Wheel removal process

- To access the spare wheel, lift the carpet up.
- After lifting, hold the carpet to access the spare wheel.



- Remove the advance warning triangle and tool tray.

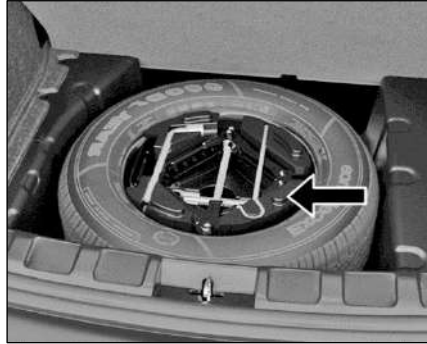

- To remove the spare wheel, unscrew and remove the retaining bolt.

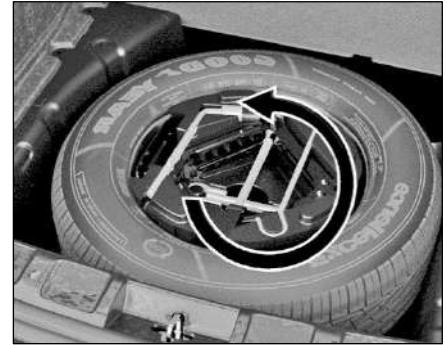

EMERGENCY AND BREAKDOWN ASSISTANCE

In Case of Flat Tyre

- Reduce vehicle speed gradually, Avoid sudden steering movement or braking.
- Pay attention to the traffic conditions as you do so.
- Switch on the hazard warning lamps.
- Stop the vehicle on solid, non-slippery and level ground, as far away as possible from traffic.
- Use the Jack on level, hard ground. Avoid changing the wheel on uphill and downhill slopes. Chocks the wheels, if the deflated wheel needs to be changed on slope / ghat area.
- If possible, bring the front wheels into the straight-ahead position.
- Secure the vehicle against rolling away.
- Set the parking brake firmly and shift into “R” (Reverse) gear on level ground while vehicle is in downhill position.
- When the vehicle is in uphill position, shift the gear in first gear.

- Switch off the engine.
- Keep advance warning triangle at a suitable distance behind the vehicle as an indication of breakdown.
- Close all the doors.

WARNING

If you drive with a flat tyre, there is a risk of the following hazards:

- A flat tyre affects the ability to steer or brake the vehicle.
- You could lose control of the vehicle.
- Continued driving with a flat tyre will permanently damage the tyre and cause excessive heat buildup and possibly a fire. There is a risk of an accident.

Changing flat tyre

Loosen the nuts (as indicated) on the wheel in diagonal sequence. Do not unscrew the nuts completely before raising the vehicle using the jack.



Wheel nut removal

EMERGENCY AND BREAKDOWN ASSISTANCE

NOTE

- The jack is designed only to raise and hold the vehicle for a short time while a wheel is being changed. It is not suited for performing maintenance work under the vehicle.
- Use the jack on level, hard ground. Avoid changing the wheel on uphill and downhill slopes. Chock the wheels, if the deflated wheel needs to be changed on slope / ghat area.
- Before raising the vehicle, secure it from rolling away by applying the parking brake.
- Do not use wooden blocks or similar objects as a jack underlay.
- Do not place your hands and feet or lie under the raised vehicle when it is supported by a jack.
- Do not run the engine when the vehicle is supported by the jack

and never allow passengers to remain in the vehicle.

- Do not open or close a door or the tailgate when the vehicle is raised.

Assemble the Jack handle and wheel spanner (as shown in fig.)

Position the jack vertically and raise it by turning the jack handle clockwise until the jack sits completely on the specified point and the base of the jack lies evenly on the ground.

The jacking points  are indicated on sill cover of the vehicle (Refer jacking point location).

Jack up point location on vehicle

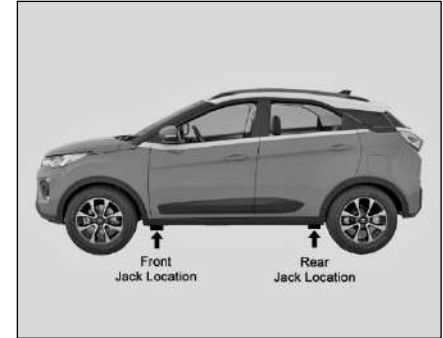

Jack up point location

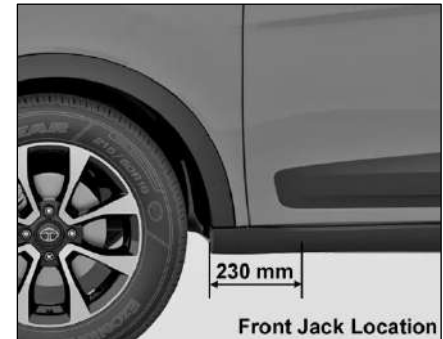

EMERGENCY AND BREAKDOWN ASSISTANCE

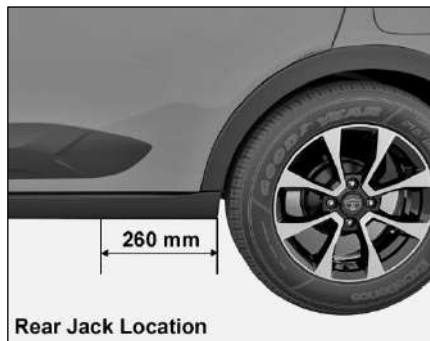

WARNING

If you do not position the jack correctly at the appropriate jacking point of the vehicle, the jack could tip over with the vehicle raised. There is a risk of injury. Also jack can be damaged.

Continue to raise the jack slowly and smoothly until the tyre clears the ground. Do not raise the vehicle more than necessary.

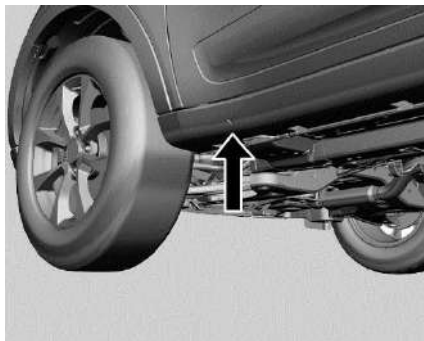

Lifting the front wheel using jack

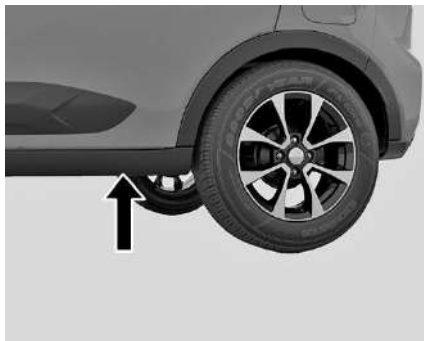

Lifting the rear wheel using jack

Remove wheel nuts with the help of wheel spanner and take out flat tyre.

NOTE

Do not place wheel nuts in sand or on a dirty surface. Do not apply oil or grease on it.

Roll the spare wheel into position and align the holes in the wheel studs.

Tighten each nut by hand until the wheel is securely seated on the hub.

Lower the jack completely then tighten the wheel nuts diagonally in opposite sequence one by one using wheel spanner.

Press fit the wheel cover back (if fitted).

Restore all the tools and jack at their respective locations.

Place the flat tyre at spare wheel location.

NOTE

- Do a check and correct the tyre pressure and wheel nuts tightness of the changed wheel at nearest authorised service station. Get the flat tyre repaired at the earliest
- Do not jack the vehicle under rear axle.

Jump starting your car

Use only a battery of same rating & capacity to jump start your vehicle. Position the booster battery close to your vehicle so that the jump leads will reach both batteries.

When using a battery of another vehicle, do not let the vehicles touch. Apply the parking brake firmly and keep the gear-shift lever in neutral.

Turn off all vehicle accessories, except those necessary for safety like hazard warning lamps.

If your vehicle is equipped with Battery sensor, then do not connect your jump start cable lead directly on the Sensor surface. Connect only on the negative cable surface as shown on the image. After jump start event, IAC function will be restored only when the Vehicle is parked in idle for 3-4 Hours.

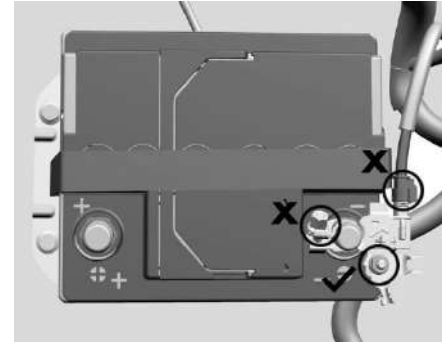

(For Diesel & Petrol)

Make jump lead connections as follows:

- Connect one end of the first jump lead to the positive (+) terminal of the discharged battery.
- Connect the other end to the positive (+) terminal of the booster battery.
- Connect one end of the second jump lead to the negative (-) terminal of the booster battery.

EMERGENCY AND BREAKDOWN ASSISTANCE

- Make the final connection (other end of the negative terminal) to an unpainted, heavy metal part (i.e. engine mounting stud/nut) of the vehicle of discharged battery.

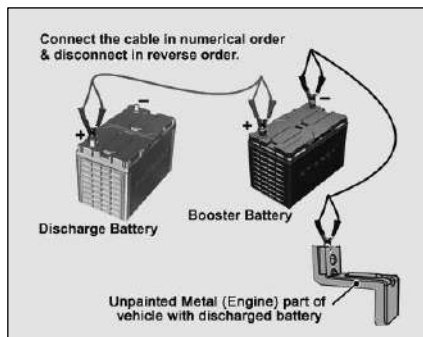

- Start the engine of the vehicle with the discharged battery.
- Before disconnecting the jumper cables, let the engine run for several minutes.

- If the booster battery you are using is fitted to another vehicle, start the engine of the vehicle with the booster battery. Run the engine at moderate speed.
- Remove the jump leads in the exact reverse order in which you connected them.

NOTE

Do not disconnect the discharged battery from the vehicle.

WARNING

- Do not connect the jump lead directly to the negative (-) terminal of the discharged battery. This may lead to an explosion.
- Do not allow battery electrolyte to come in contact with eyes, skin, fabrics or painted surfaces. The fluid contains acid which can cause injury and severe damage. Wear protective apparel. Do not inhale any battery gases. Keep

children away from batteries. In case if battery acid comes in contact with the skin, wash it off immediately with water and seek medical attention.

- During charging and jump-starting, explosive gases can escape from the battery. There is a risk of an explosion. Particularly avoid fire, open flames, creating sparks and smoking. Make sure that there is sufficient ventilation while charging and jump-starting. Do not lean over the battery.
- Make sure that the positive terminal of a connected battery does not come into contact with vehicle parts. Never place metal objects or tools on a battery.
- It is important that you observe the described order of the battery terminals when connecting and disconnecting a battery. If you are in doubt, seek assistance from qualified specialist workshop.

EMERGENCY AND BREAKDOWN ASSISTANCE

- Do not connect or disconnect the battery terminals while the engine is running.

Towing

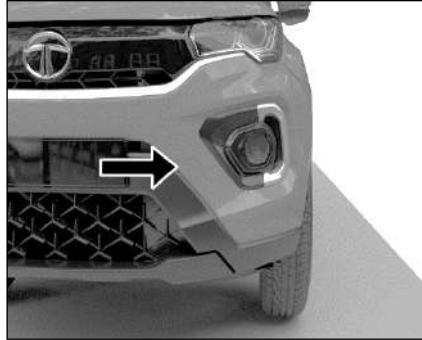

When towing a break down vehicle, certain precautions and procedures must be taken to prevent damage to the vehicle and/or components. Failure to use standard towing precautionary measures when lifting or towing a break down vehicle could result in an unsafe operating condition.

To correctly tow and prevent accidental damage to your vehicle, take help of a TATA MOTORS authorized dealer or a commercial tow-truck service.

NOTE

Make sure that the parking brake is released; vehicle is in neutral and steering wheel is unlocked. The power steering functions only when engine is running. Hence, during towing the steering efforts will be more.

WARNING

- Do not get under your vehicle after it has been lifted by a tow truck.
- For towing a vehicle, the best way is to use a wrecker. Alternatively use a rigid tow bar.
- Switch 'ON' the hazard warning indicators of both the vehicles to warn other road users.
- Limit the speed to 20-30 kmph.
- In case of brake failure, use the parking brake to control the vehicle.

EMERGENCY AND BREAKDOWN ASSISTANCE

- Fasten the tow rope or tow bar at the towing eyes. Otherwise, the vehicle could be damaged.
- When towing, pull away slowly and smoothly. If the tractive power is too high, the vehicles could be damaged.

Tow hook fitment

- Open the tailgate and remove tow hook from the tool kit.

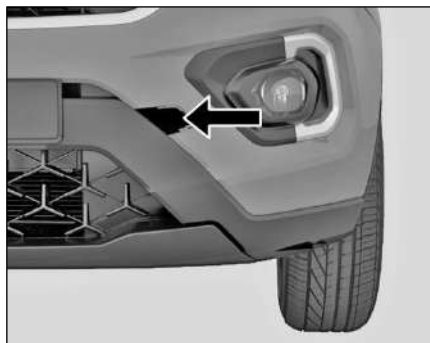

- Open the tow hook cover provided on the front bumper by pressing it at the

bottom part and simultaneously pulling it at the top (as shown in fig).

- Screw in and tighten the tow hook in clockwise direction.
- After towing, remove the towing hook and press fit the cover properly.
- Place the towing hook in the vehicle tool kit.

Recommended towing

In case of break down, we recommend that your vehicle be towed with the driving wheels off the ground or place the vehicle on a flatbed truck as shown.

WARNING

- Do not tow your vehicle with the front wheels on the ground or four wheels on the ground (forward or backward), as this may cause serious damage to the transmission.

- When towing with the rear wheels on the ground or on towing dollies, place the ignition switch in the 'ACC' or 'ON' position, and secure the steering wheel in the straight-ahead position with a rope or similar device.

EMERGENCY AND BREAKDOWN ASSISTANCE

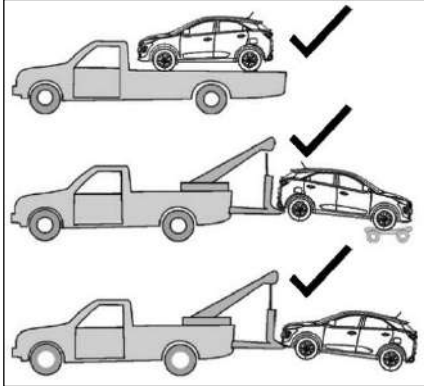
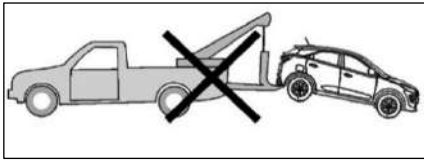

Fuses

Your vehicle has fuse boxes at three locations.

The vehicle's electrical circuits have fuses to protect the wiring from short circuits or sustained overload.

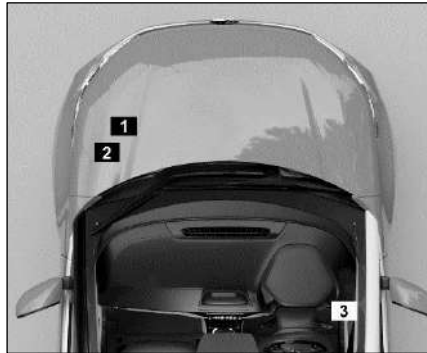

1. Battery Mounted Fuse Box.
2. Engine Compartment Fuse Box.
3. Cabin Compartment Fuse Box.

Checking and replacing fuses

If any electrical unit in your vehicle is not functioning, check the fuses first.

Please follow the steps below that will guide you to check and replace them.

- Apply parking brake
- Switch off all electrical accessories.
- Turn the ignition key to the 'LOCK' position.
- In the fuse box, identify the defective fuse from its melted wire.

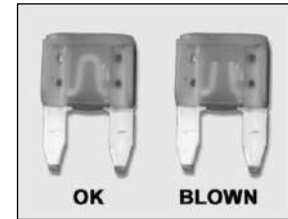

- Remove the defective fuse by "fuse puller". The fuse puller and spare fuses are provided in the engine compartment fuse box.

EMERGENCY AND BREAKDOWN ASSISTANCE

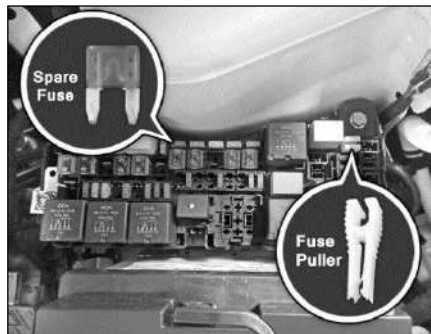

Engine compartment fuse box

- Defective fuses must be replaced with fuses of same rating, which you can recognize by color and value.

NOTE

Always make sure that the spare fuses are added.

- Make sure that all other fuses are pressed firmly in position.
- If a newly inserted fuse also blows, have the cause traced and rectified at nearest TATA MOTORS Authorized Dealer/Service Center immediately.

WARNING

- If you manipulate or bridge a faulty fuse or if you replace it with a fuse with higher amperage, the electric cables could be overloaded. This could result in a fire. There is a risk of an accident and injury.
- Always replace faulty fuses with the specified new fuses having the correct amperage.

Battery mounted fuse box (Diesel)

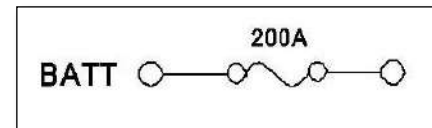
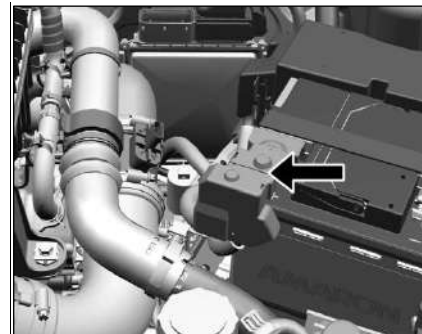

Fuse No.	Function	Fuse Rating
F01	STARTER MOTOR	200A

EMERGENCY AND BREAKDOWN ASSISTANCE

WARNING

If fuse box cover is removed for any reason, it should be refitted properly in its original position.

Battery mounted fuse box (Petrol)

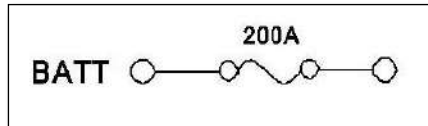
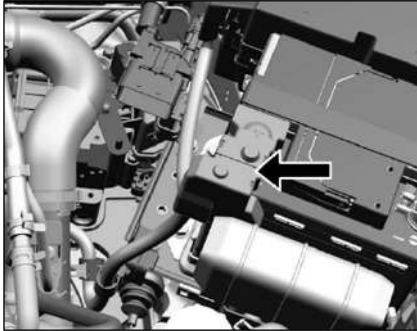

Fuse No.	Function	Fuse Rating
F01	STARTER MOTOR	200A

WARNING

If Fuse box cover is removed for any reason, it should be refitted properly in its original position.

Engine compartment fuse box (Diesel)

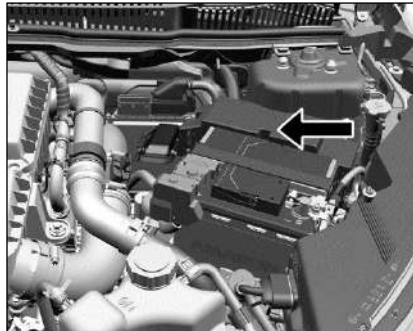

NOTE

The fuse box layout is for reference purpose only. Please refer the sticker provided inside the fuse box cover.

Engine compartment fuse box (Petrol)

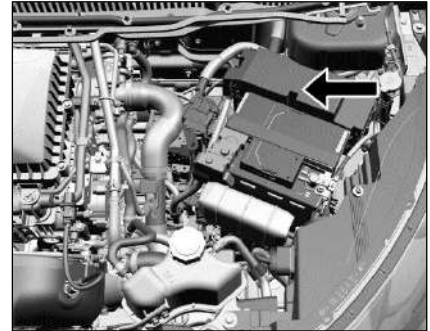

NOTE

The fuse box layout is for reference purpose only. Please refer the sticker provided inside the fuse box cover.

EMERGENCY AND BREAKDOWN ASSISTANCE

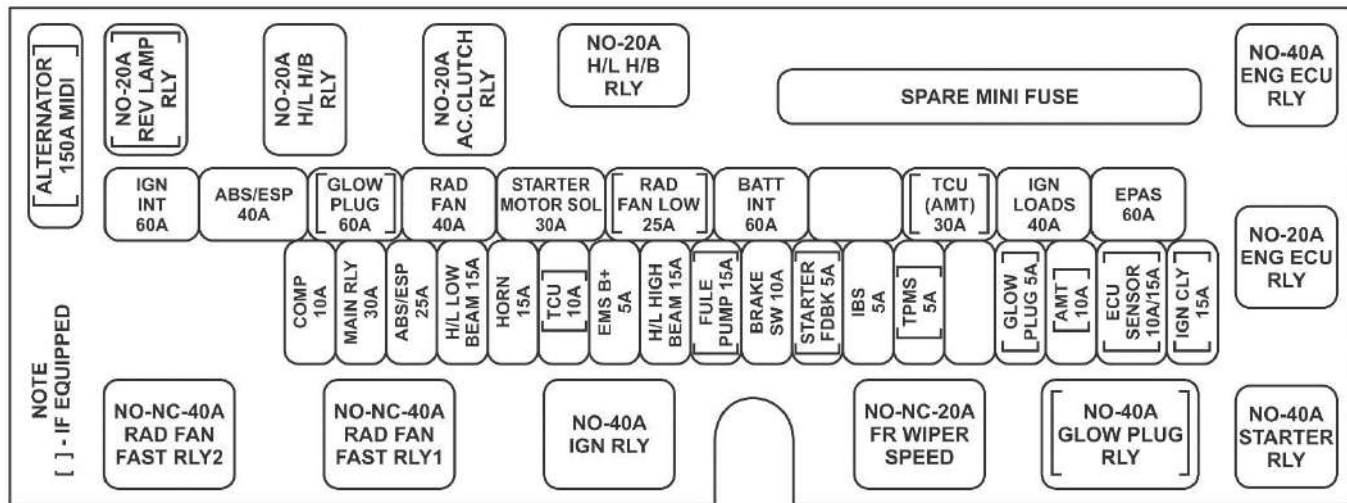

EMERGENCY AND BREAKDOWN ASSISTANCE

Cabin compartment fuse box

Cover removal procedure

Fuse box is located inside the cover below steering column. To access the fuse box, remove cover as per procedure given below.

1. Fuse box cover is mounted on dash board with the help of lugs at the top and bottom of the cover from inside.

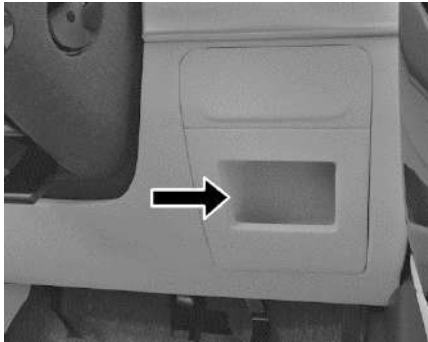

2. To remove the cover, gently pull the cover from upper side that the lugs get disengaged.

Re-fitment procedure

Align bottom lugs and push upper part with respective slots on dash board and press the cover firmly.

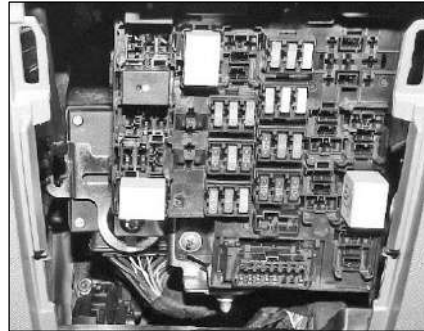

Cabin compartment fuse box

Fuses - Cabin Compartment

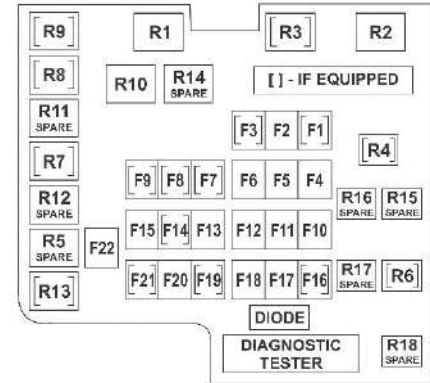

Fuse No.	Function	Fuse Rating
1	BCM	20A
2	ACC B+ VE / OBD	15A
3	PWR SKT RR	15A
4	BCM	20A
5	BCM	20A
6	BLOWER	30A
7	MIR ADJ MTR	5A

EMERGENCY AND BREAKDOWN ASSISTANCE

8	PWR SKT FRT	15A
9	SUNROOF	20A
	AFTERMKT ACC	15A
10	AIRBAG	5A
11	EPAS	5A
12	IGNITION	10A
13	IGN SW	10A
	PEPS	
14	CDL	15A
15	CLUSTER	5A
16	T/G ACT	10A
17	PDC IGN	5A
18	HVAC	10A
19	IGN-ACC	5A
	HRW	25A
20	IGN KEY-IN	5A
	PEPS	
21	TELEMATIC ECU	5A
22	TRANSIT / INFO	20A

EMERGENCY AND BREAKDOWN ASSISTANCE

Bulb Specification

SN.	Description	Rating	Type	Qty.
1	HIGH BEAM + LOW BEAM	12V, 55W	H7	4
2	TURN SIGNAL FRONT (Option I)	LED	LED MODULE	2
3	TURN SIGNAL FRONT (Option II)	12V, 21W	WY21W	2
4	TURN SIGNAL REAR	12V, 21W	WY21W	2
5	FOG LAMP FRONT (If applicable)	12V, 19W	H16	2
6	STOP LAMP	LED	LED MODULE	2
7	POSITION LAMP FRONT	LED	LED MODULE	2
8	POSITION LAMP REAR	LED	LED MODULE	2
9	REVERSE LAMP	12V, 10W	R10W	2
10	REAR REGISTRATION PLATE LAMP	LED	LED MODULE	2
11	SIDE REPEATER LAMP- ON ORVM	LED	LED MODULE	2
12	ROOF LAMP	LED	LED MODULE	1
13	HIGH MOUNTED STOP LAMP	LED	LED MODULE	1
14	REAR BOOT LAMP	12V, 5W	W5W	1
15	GLOVE BOX LAMP	12V, 5W	W5W	1
16	DRL	LED	LED MODULE	2

EMERGENCY AND BREAKDOWN ASSISTANCE

24 X 7 Road Assistance

Dear Customer,

It is our responsibility and our endeavor to ensure that you have our complete service backup if ever, wherever and whenever you need the same. When you have a road network that spans wide area, the probability of a breakdown happening within hailing distance of a TATA MOTORS Authorized Workshop is very low.

It is precisely for this reason, we have tied up with TVS AA, who will provide breakdown assistance including towing to the nearest TATA MOTORS Authorized Workshop through their Authorized Service Providers (ASP).

The 24X7 On Road Assistance Program shall be automatically available to your vehicle for the duration of Warranty period. The program shall also be available, if you avail the same post warranty.

Response Time ** for the On Road Assistance Program

Within City Limits	60 minutes
On State or National Highways	90 minutes
Ghat Roads and other places	120 minutes +/-

** (The response time will depend on the location, terrain, traffic density and the time of the day.)

Standard procedure when calling for On Road Assistance in case of a breakdown:

- Dial the toll free help line number – **1800 209 7979**
- Identify your vehicle with the Vehicle chassis number that is available in the Owner's Manual.
- Explain your exact location with landmarks and tell us about the problem you face with the vehicle.

- Park your vehicle on the edge of the road, open the bonnet and put on the hazard warning signal.
- Place the advance warning triangle supplied with the vehicle approx. 3 m from the vehicle in the direction of oncoming traffic.



Coverage under 24 X 7 on Road Assistance Program

I. The **24x7 On Road Assistance** Program Service covers the following services on your vehicle during warranty period.

EMERGENCY AND BREAKDOWN ASSISTANCE

- Wheel change through spare wheel.
- Arrangement of fuel. (Fuel cost will be chargeable at actual cost).
- Re-opening the vehicle in cases of key lock out.
- Rectification of electrical problems related to battery, fuses etc.
- On spot repairs for complaints repairable at site. ^
- Vehicle to vehicle towing or winching & towing for non-accident cases up to the nearest TATA MOTORS Authorized Dealer/Service Center. Towing charges at actual cost beyond the same to be paid to the ASP in cash. (Any ferry or toll charges levied in relation to the vehicle being towed to be paid by the customers in actuals in cash).

For accident cases, towing charges to be borne by the customer.

II. The **24x7 On Road Assistance** Program coverage on availing the 24X7 policy, post warranty is upto maximum of 6 instance of assistance in one year for

both the plans- Basic and Premium. In the premium plan, this includes 2 instances of towing up to the nearest TATA MOTORS Authorized Dealer/Service Center.

Exclusions

24 X 7 On Road Assistance Program does not apply to

- Cost of parts consumables and labor for such repairs not covered under warranty*. These charges are to be settled with ASP in cash.
- Toll or ferry charges paid by ASP in reaching to the breakdown site to be settled with ASP in actuals in cash.
- Cases involving accident, fire, theft, vandalism, riots, lightening, earthquake, windstorm, hail, tsunami, unusual weather conditions, other acts of God, flood, etc.
- Vehicles that are unattended, un-registered, impounded or abandoned.
- Breakdown/defects caused by misuse, abuse, negligence, alterations or modifications made to the vehicle.

- Lack of maintenance as per the maintenance schedule as detailed in the owner's manual.
- Cases involving racing, rallies, vehicle testing or practice for such events.

Disclaimer

- The Service is not available in Lakshadweep.
- **The reach time is indicative & the actual reach time will be conveyed by the call center at the time of breakdown call.
- The reach time can vary depending on the traffic density & time of the day.
- The reach time indicated does not account for delays due to but not limited to acts of God, laws, rules & regulations for time being in force, orders of statutory or Govt. authorities, industrial disputes, inclement weather, heavy down pour, floods, storms, natural calamities, road blocks due to accidents, general

EMERGENCY AND BREAKDOWN ASSISTANCE

strife and law & order conditions viz. fire, arson, riots, strikes, terrorist attacks, war etc.

^ On spot repairs at breakdown site shall depend on nature of complaints & will be as per the discretion of the ASP.

* The decision for free of charge repairs will be as per the warranty policy & procedures of TATA MOTORS LTD. and as per the interpretation of the same by ASP. You will be duly informed by the ASP & call center for the change applicable if any.

- All charges wherever applicable need to be settled directly with the ASP.

Exclusion of Liabilities

- It is understood that TATA MOTORS shall be under no liability whatsoever in respect of any loss or damage arising directly or indirectly out of any delay in or non-delivery of, defect/deficiency in service/parts provided by ASP.

- In case vehicle cannot be repaired on-site, customers are advised to use the towing facility for taking their vehicle to the nearest TATA MOTORS authorized workshop only. In no condition shall the vehicle be towed to any unauthorized workshop. TATA MOTORS will not be responsible for any repairs carried out in such unauthorized workshop.
- Customer are advised to take acknowledgment from the ASP for the list of accessories/extra fittings and other belongings in the vehicle as well as the current condition related to dents/scratches breakages of parts/fitments of the vehicle at the time of ASP taking possession of the vehicle & to verify these items when delivery is taken back by them, Claim for loss of or damage to items, if any should be taken up with ASP directly. TATA MOTORS shall not be responsible for any such claims, damages/loss or any deficiency of service of the ASP.
- Vehicles will be handled, repaired & towed as per the customer's risk & TATA MOTORS shall not be liable for any damages / claims as a result of the same.
- Services entitled to the customers can be refused or cancelled on account of abusive behavior, fraudulent representation, malicious intent and refusal to pay the charges for any charges related services and spare parts during service or on previous occasions on part of the customer.
- On site repairs may be temporary in nature. The completion of repairs does not certify the road worthiness of the vehicle. The customer is advised to ensure temporary repairs carried out onsite is followed by permanent repairs at a TATA MOTORS Authorised Dealer/Service Center at the earliest. Terms and conditions and service coverage, exclusions etc. are subject to change without notice.

Maintenance and Service

Periodic maintenance is essential for ensuring long trouble free performance.

Have your vehicle serviced regularly from TATA MOTORS Authorized Dealer/Service Center.

There is a large network of TATA MOTORS Authorized Service Centre to help you with their professional servicing expertise. Scheduled maintenance information is provided which makes tracking routine service easy.

The following checks can be carried out between the recommended scheduled maintenance services. Take help of our authorized service center for assistance.

- Engine oil level
- Engine coolant level
- Brake fluid level
- Washer fluid level checking & topping up
- Battery electrolyte level
- Tyre inflation pressure including spare wheel

NOTE

Refer "Opening and Closing" section for engine bonnet opening.

WARNING

- Be careful not to touch a hot engine, exhaust manifold and pipes, muffler, radiator and water hoses.
- Do not work on a vehicle with the engine running in an enclosed space, unless you are sure of enough ventilation.
- Keep all open flames and other burning material (such as cigarettes) away from the battery and all fuel related parts.

If you need to do any work inside the engine compartment,

- Switch off the ignition
- Never reach into the area where there is a risk of danger from moving components, such as the fan rotation area.
- Keep clothing away from moving parts.

MAINTENANCE

Engine Compartment - Diesel

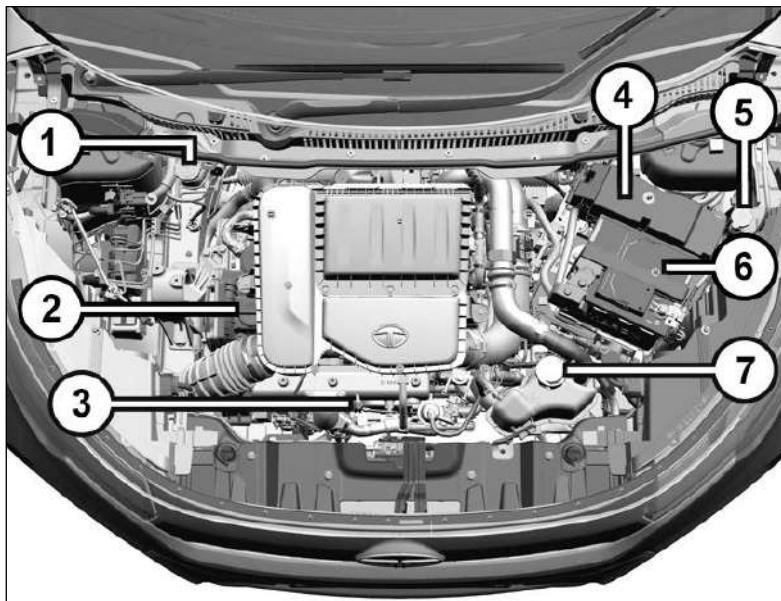

1. Brake fluid reservoir
4. Fuse and relay Box
7. Coolant auxiliary tank

2. Engine oil filling cap
5. Windshield washer container

3. Dip stick engine oil
6. Battery

Engine Compartment – Petrol with AMT

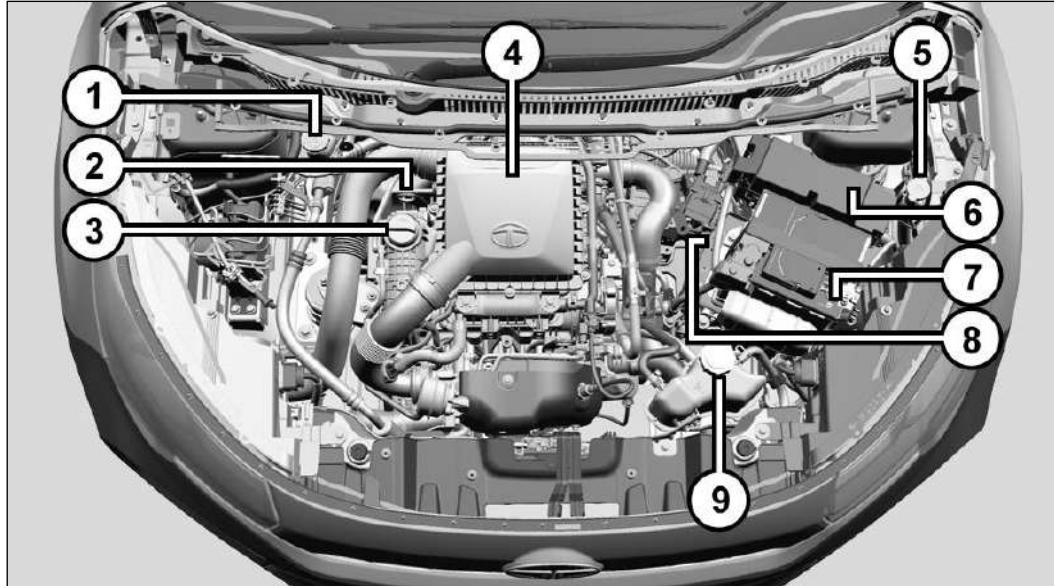

- 1. Brake fluid reservoir
- 4. Air Filter
- 7. Battery

- 2. Dip Stick – Engine Oil
- 5. Windshield washer container
- 8. AMT oil reservoir (for AMT)

- 3. Engine oil filling cap
- 6. Fuse & relay box
- 9. Coolant auxiliary tank

MAINTENANCE

Engine Oil Level

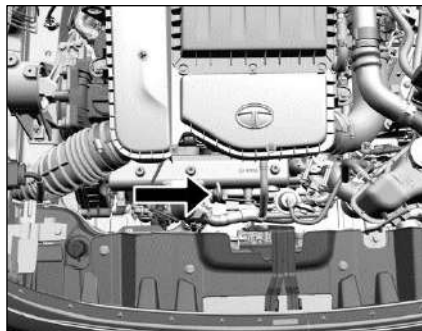

Dipstick location Engine oil (Diesel)

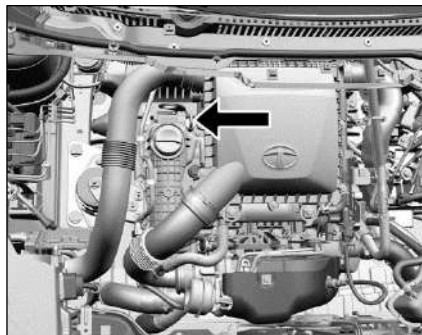

Dipstick location Engine oil (Petrol)

Warm up the engine to normal operating temperature.

Turn it 'OFF' and wait for 5 minutes for the oil to return to the oil pan. Be sure the vehicle is on a level surface.

Take out the dipstick, wipe it clean, and reinsert it fully. Pull it out again and examine the oil level. It should be between 'MIN' and 'MAX' level. If not, top up with recommended engine oil.

NOTE

The oil consumption depends upon the driving style and the conditions under which the vehicle is used.

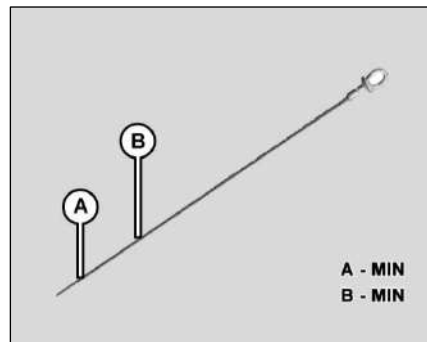

Petrol

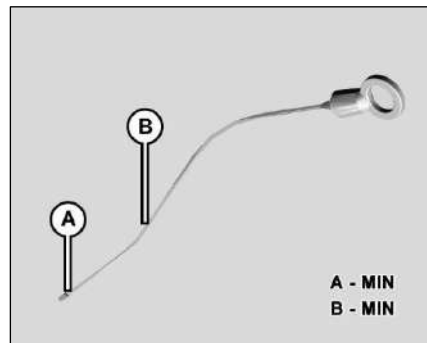

Diesel

NOTE

- Do not remove the filler cap when the engine is running.
- Do not add oil above than the MAX. mark. Oil level above the MAX. mark may cause engine damage.

For location of Engine oil filling cap and dip stick, please refer image of the respective Engine Compartment.

Brake Fluid Level

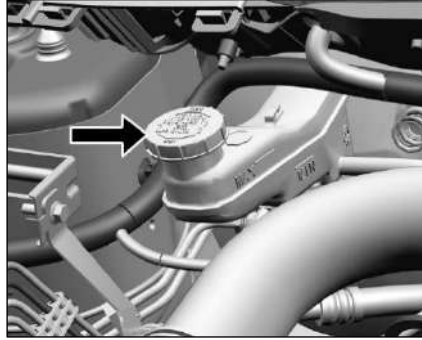

Brake Fluid Level (Petrol)



Brake Fluid Level (Diesel)

The level of the brake fluid should be between the 'MIN' and 'MAX' marks provided on the side of the brake fluid container. If the level falls below the 'MIN' mark, add recommended brake fluid.

NOTE

- Do not allow brake fluid to make contact with the skin or eyes.
- Do not allow brake fluid to splash or spill on the paint surface as it will damage the paint. In case of spillage, wipe it off immediately.

For location of Brake Fluid Container and filling cap, please refer respective Engine Compartment.

MAINTENANCE

Engine Coolant Level

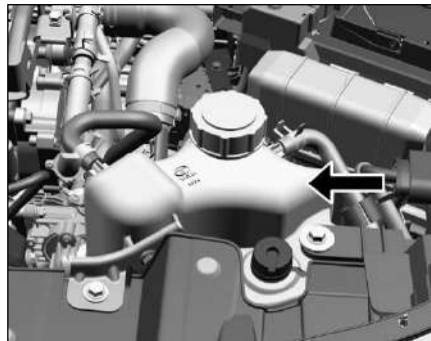

Engine Coolant Level (Petrol)

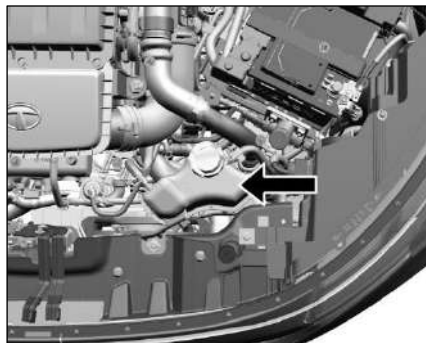

Engine Coolant Level (Diesel)

Check whether the coolant level is between the 'MIN' and 'MAX' marks provided on the coolant reservoir.

When the coolant level is low, top up with recommended coolant up to 'MAX' level.

NOTE

In case of emergency, a large amount of water without engine coolant may be added in order to reach a vehicle service location.

Whenever coolant has been added, the coolant level in the coolant reservoir should be checked the next few times you drive the vehicle to confirm correct level.

For location of Engine coolant container and filler cap, please refer image of Engine Compartment.

NOTE

Topping up of the coolant should be done in the auxiliary tank only.

Make sure that only TATA MOTORS recommended coolant is used. Mixing of different coolants may harm your engine's cooling system and its components. Do not add extra inhibitors or additives to the coolant. These can be harmful and compromise the corrosion protection of the engine coolant.

WARNING

The engine cooling system is pressurized, particularly when the engine is warm. When opening the cap,

you could be scalded by hot coolant spraying out. There is a risk of injury.

Let the engine cool down before opening the cap. Wear eye and hand protection when opening the cap. Open the cap slowly half a turn to allow pressure to escape.

Windshield Washer Fluid Level

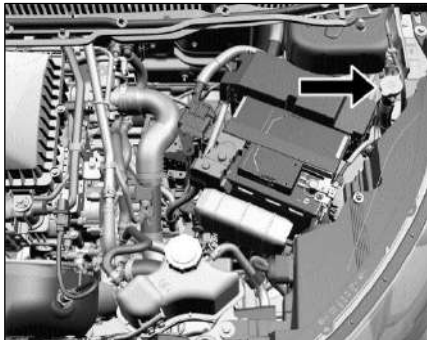

Windshield Washer Fluid Level (Petrol)

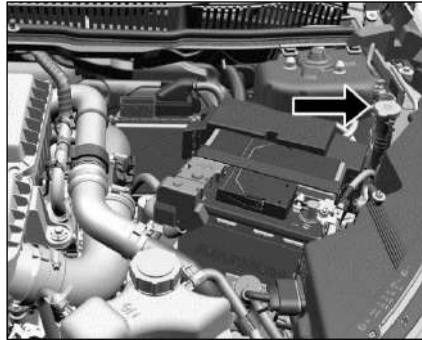

Windshield Washer Fluid Level (Diesel)

Examine if there is washer fluid in the tank. Fill it if necessary. Use a good quality windshield washer fluid, diluted with water as necessary.

NOTE

Do not use detergent or any other additive in the windshield washer reservoir. This can severely impair visibility when sprayed on the windshield, and can also damage your vehicle's paint.

Do not operate washer motor with no fluid in washer tank, washer motor will be damaged

For location of Windshield Washer Container and filling cap, please refer image of the respective Engine Compartment.

MAINTENANCE

Battery

- Examine the battery for electrolyte level against the marking on the battery outer case.
- Examine the battery terminals for corrosion (a white or yellowish powder). To remove it, wash the terminals with a solution of baking soda. It will bubble up and turn brown.
- When this stops, wash it off with plain water. Dry off the battery with a cloth or paper towel.
- Apply petroleum jelly to the terminals to prevent further corrosion.
- Use a proper wrench to loosen and remove cables from the terminals.
- Always disconnect the negative (-ve) cable first and reconnect it last.
- If your vehicle is equipped with Battery Sensor, then disconnect only the Sensor Output Cable. Do not remove the Sensor, Sensor connector completely as this will result into Sensor

function loss temporarily. Sensor functionality will be restored when the Vehicle is parked for 3-4 hours without any operation.

- Clean the battery terminals with a terminal cleaning tool or wire brush.
- Reconnect and tighten the cables, coat the terminals with petroleum jelly.
- Make sure that the battery is securely mounted.
- If you need to connect the battery to a charger, disconnect both cables to prevent damage to the vehicle's electrical system.
- If your vehicle is equipped with Battery Sensor, connect the jump start leads on output terminal of Battery Sensor. Do not connect the jump start leads on Sensor surface or Battery terminal. This will result of function loss of Battery sensor.

- Refer the below Battery Sensor image for do's and don'ts.

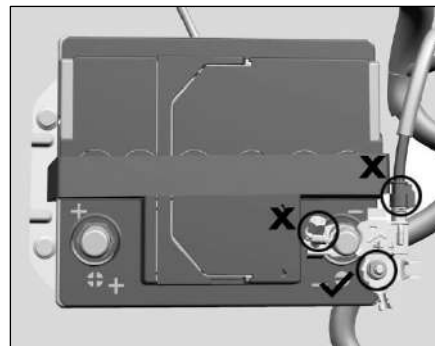

Battery (Petrol & Diesel)

For location of battery, please refer image of the respective Engine Compartment.

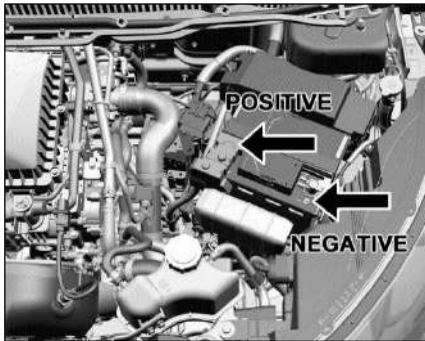

Battery (Petrol)

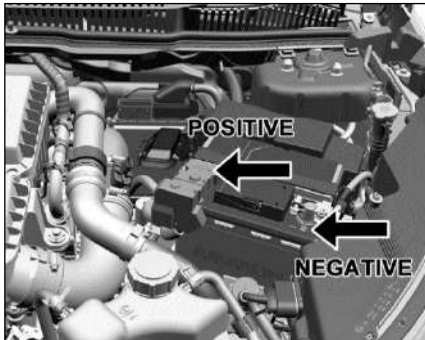

Battery (Diesel)

NOTE

Use only authorized Battery recommended by TATA Motors. Use of any other unauthorized Battery will result into Intelligent Alternator Control (IAC) function deterioration.

NOTE

Authorized Battery:

- For Petrol
47Ah- Enhanced flooded battery to be replaced with enhanced flooded battery (47Ah) of the respective supplier only.
- For Diesel
52Ah- Enhanced flooded battery to be replaced with enhanced flooded battery (52Ah) of the respective supplier only

NOTE

- During normal operation, the battery generates gas which is explosive in nature. A spark or open flame can cause the battery to explode causing very serious injuries.
- Keep all sparks, open flames and smoking materials away from the battery.
- The battery contains sulphuric acid (electrolyte) which is poisonous and highly corrosive in nature. Getting electrolyte in your eyes or on the skin can cause severe burns. Wear protective clothing and a face shield or have a skilled technician to do the battery maintenance.

MAINTENANCE

Spark Plug (Petrol)



Spark Plug	Number	Gap
BOSCH	YR5ME0	0.7 to 0.8 mm

Tightening Torque - 15 - 25 Nm

NOTE

Use spark plug of recommended make & type for replacement.

Tyres

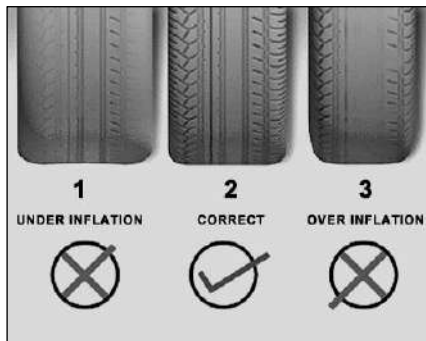

1	Under inflation	Excessive side tread wear
2	Correct tyre pressure	Uniform wear
3	Over inflation	Excessive center tread wear

Inflation

Do a check of the tyre pressure and the tyres condition periodically.

Examine the pressure in the tyres when they are cold.

Keep the correct pressure in the tyres for the best combination of riding comfort, handling, tyre life and optimum performance.

Over inflation of tyres makes the vehicle ride bumpy and harsh. Tyres are more prone to uneven wear and damage from road hazards.

Under inflated tyres reduce comfort, affects handling and increases the operating temperature, which can result in failure. They also cause uneven wear and bring down the performance of the car.

NOTE

Every time you check inflation pressure, you should also examine tyres for uneven wear, damage and trapping of foreign objects in the treads and wear.

Recommended tyre pressures

Tyre size	Front	Rear	Spare
215/60 R16	30 psi / 2.07 bar	30 psi / 2.07 bar	30 psi / 2.07bar
195/60 R16	32 psi / 2.20 bar	32 psi / 2.20 bar	32 psi / 2.20bar

NOTE

This is for reference. Kindly refer Tyre pressure as indicated on tyre pressure sticker provided on vehicle.

Tyre pressure sticker location

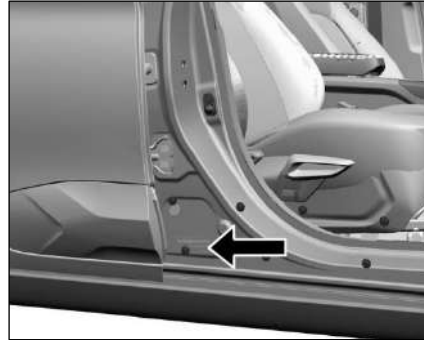

Tyre rotation

To increase tyre life rotate the tyre at specified intervals or earlier depending on the operation of vehicle. The illustrations shows how to rotate tyres.

For 195/60 R16

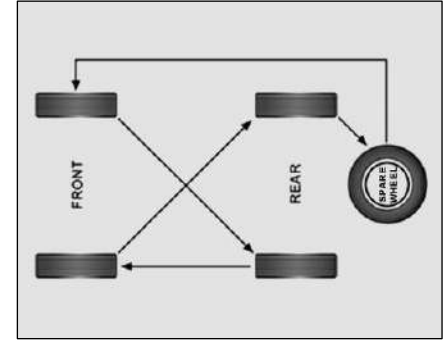

MAINTENANCE

For 215/60 R16 tyre with smaller size temporary tyre equipped

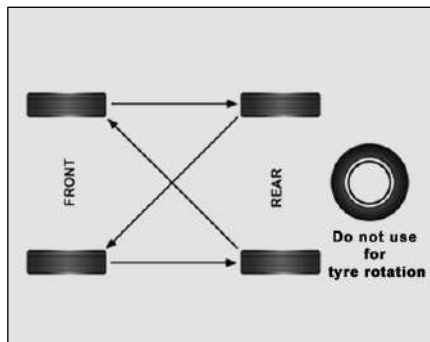

NOTE

- Do not use spare wheel for tyre rotation, in case of temporary spare wheel used.
- Two or more temporary tyres should not be used on one vehicle.
- Tyre pressure of temporary wheel is to be checked at least once in in a month.

Wheel Alignment

Incorrect wheel alignment causes excessive and uneven tyre wear. Check wheel alignment at specified intervals.

Wheel Balancing

Wheels of your vehicle are balanced for better ride comfort and longer tyre life. Balancing needs to be done whenever tyre is removed from rim.

WARNING

If the vehicle vibrates abnormally on a smooth road, have the wheel balanced done immediately.

Special care for tubeless tyres:

- When you remove the tyre and install it back on the rim, take precautions not to damage tyre bead. Use tyre removal and assembly machines. Damage or cut on tyre bead may cause gradual loss of air and deflation of tyre.
- Do not scratch the inner surface of tubeless tyre with metallic or sharp object. Tubeless tyres are coated with impermeable layer of rubber from the inner surface which holds the air in the tyre. Removal of this layer due to scratching may cause gradual loss of air and deflation.
- If wheel rim gets damaged in service, get the wheel rim repaired/ replaced immediately. Running the vehicle with damaged rim may cause deflation of tyre and subsequent dislodging of tyre from rim.

- Keep the recommended inflation pressure. Over-inflation, in particular, may cause puncture or bursting of tyre.

NOTE

Life and wear pattern of tyres depends on various parameters like tyre pressure, wheel alignment, wheel balancing, tyre rotation, etc. It also largely depends on vehicle speed, load carried, usage, driving habits, road conditions, tyre quality, etc. In case fault is suspected to be due to poor quality of tyres, the same may be taken up with concerned tyre manufacturer.

Smart Key Battery Replacement

(For PEPS variant)

Procedure:

1. Open rear side of key (battery cover).



2. Replace with new battery in the smart key battery slot.
3. Ensure that the “+” symbol on the battery is facing upwards. The correct polarity is shown on the battery cover.
4. Close the battery cover.

5. Make sure that the key cover is intact properly.

NOTE

- Use CR 2032 battery only.
- An inappropriately disposed battery can be harmful to the environment and human health. Dispose the battery according to your local law(s) and regulation.

Wearable key battery replacement procedure

Battery status of the wearable key fob:

- If customer presses the driver door handle switch or tailgate switch for 2-3 times with valid wearable and if the passive entry is not working, the wearable key fob's battery is low.
- As standby he can use Smart Key (UID) or emergency key for entry
- Customer to contact nearby dealer or service station for battery replacement

MAINTENANCE

Battery Specifications

- Lithium Battery CR1632
- Voltage 3V
- Make: Panasonic, Renata

NOTE

Battery life is 10 months or 25,000 PKE cycles (whichever comes earlier).

Battery replacement

- Remove the screws from backside of wearable key fob.
- Remove back-cover
- Remove battery from wearable key
- Place new battery
- Put the back cover and screw it with all the four screws.



On Board Diagnostic (OBD II) System

On board Diagnostics or OBD, is an automotive term referring to a vehicle's self-diagnostic and reporting capability. The OBD system allows continuous diagnosis of the components of the vehicle correlated with emissions. This system warns the driver, by turning "ON" the Malfunction Indication lamp (MIL) on the instrument cluster, when a fault causes emission levels to increase.

The OBD system also has a diagnostic connector that can be interfaced with appropriate diagnostic tools, which makes it possible to read the fault codes stored in the Electronic Control Unit, together with a series of specific parameters for Engine operation and Diagnosis. This check can also be carried out by the traffic police.

On board diagnostic located in Engine compartment fuse box. (refer below image)



Location of On board diagnostic (OBD II)

Service Instructions

The **TATA NEXON** has been manufactured to give you economical and trouble free performance. To achieve this, please follow the instructions as stated.

Your vehicle is entitled to three free services (labour only). The free service coupons are attached to the sales invoice. Please present these coupons to the servicing dealer while availing free services.

1st free service - At 1000-2000 kms. OR 2 months, whichever is earlier.

2nd free service - At 7000-8000 kms. OR 6 months, whichever is earlier.

3rd free service - At 14500-15500 kms. OR 12 months, whichever is earlier.

All services other than free services are chargeable.

Servicing of the vehicle can be done at any TATA MOTORS Authorised Dealer Workshop or TATA MOTORS Authorised Service Centre (TASC).

Warranty claims can be settled by any TATA MOTORS Authorised Dealer Workshop or TATA MOTORS Authorised Service Centre (TASC).

MAINTENANCE

Service Schedule

S.N	Operation	Kms	PDI	1.5K	7.5K	15K	22.5K	30K	37.5K	45K	52.5K	60K	67.5K	75K	82.5K	90K	97.5K	105K	112.5K	120K	127.5K	135K	142.5K	150K		
		Months	0	2	6	12	18	24	30	36	42	48	54	60	66	72	78	84	90	96	102	108	114	120		
General																										
1	Wash the vehicle & Clean Condenser Fins	Every Service	•	•	•	•	•	•	•	•	•	•	•	•	•	•	•	•	•	•	•	•	•	•	•	
2	Check & Top up Fluids (If required): Transaxle Oil, Coolant, Brake Fluid, Battery Electrolyte, Wind Screen washer fluid.	Every Service	•	•	•	•	•	•	•	•	•	•	•	•	•	•	•	•	•	•	•	•	•	•	•	
3	Check Fuel Lines for Leakages.	Every Service	•	•	•	•	•	•	•	•	•	•	•	•	•	•	•	•	•	•	•	•	•	•	•	
4	Check and Capture all DTC's Clear all faults and Erase the Codes.	Every Service	•	•	•	•	•	•	•	•	•	•	•	•	•	•	•	•	•	•	•	•	•	•	•	
5	Check & Replace if found damaged -- Exhaust hanger , Suspension bushes	30K/ 24M						•				•				•				•				•		
6	Check All door latch & striker operations, Adjust & Apply grease If required.	15K/ 12M				•		•		•		•		•		•		•		•		•		•		
7	Check for all bolts & nuts (tighten).	7.5K / 6M			•	•	•	•	•	•	•	•	•	•	•	•	•	•	•	•	•	•	•	•	•	

- Kms or months whichever occurs earlier

MAINTENANCE

S.N	Operation	Kms	PDI	1.5K	7.5K	15K	22.5K	30K	37.5K	45K	52.5K	60K	67.5K	75K	82.5K	90K	97.5K	105K	112.5K	120K	127.5K	135K	142.5K	150K		
		Months	0	2	6	12	18	24	30	36	42	48	54	60	66	72	78	84	90	96	102	108	114	120		
8	Check condition of Rubber bushes/ parts in lower link, front & rear coil spring seats, front & rear bump stoppers, anti-roll bar, rear twist beam, front & rear dampers, rubber boot/dust cover/bellow in rack & pinion, steering and suspension ball joints, steering column. Replace if necessary (First at 15K/12M then at every service).	7.5K / 6M				•	•	•	•	•	•	•	•	•	•	•	•	•	•	•	•	•	•	•		
Engine (Diesel)																										
1	Clean air filter element (more frequently for vehicle operating in severe condition)	7.5K / 6M			•	•	•	•	•	•	•	•	•	•	•	•	•	•	•	•	•	•	•	•	•	
2	Change engine oil and Oil filter	15K / 12M				•		•		•		•		•		•		•		•		•		•	•	
3	Drain water from Fuel Filter Bowl	15K / 12M				•		•		•		•		•		•		•		•		•		•	•	
4	Replace fuel filter assembly replaced based on lamp status/24M	# 24M																								

MAINTENANCE

Sr. No.	Operation	Kms	PDI	1.5K	7.5K	15K	22.5K	30K	37.5K	45K	52.5K	60K	67.5K	75K	82.5K	90K	97.5K	105K	112.5K	120K	127.5K	135K	142.5K	150K
		Months	0	2	6	12	18	24	30	36	42	48	54	60	66	72	78	84	90	96	102	108	114	120
5	Check AC & alternator belt condition visually, replace if found damage.	15K / 12M				•		•		•		•		•		•		•		•		•		•
6	Check timing belt visual condition, replace if found damage.	# 105K / 24M																•						
7	Replace air filter element (30K/24M for vehicle operating in severe condition)	45K / 36M								•						•						•		
8	Change coolant	# 60K / 36M										•								•				
9	Replace timing drive kit (Timing belt, Auto tensioner and Idler)	# 150K / 36M																						•

- Kms or months whichever occurs earlier

MAINTENANCE

Sr. No.	Operation	Kms	PDI	1.5K	7.5K	15K	22.5K	30K	37.5K	45K	52.5K	60K	67.5K	75K	82.5K	90K	97.5K	105K	112.5K	120K	127.5K	135K	142.5K	150K
		Months	0	2	6	12	18	24	30	36	42	48	54	60	66	72	78	84	90	96	102	108	114	120
	Engine (Petrol)																							
1	Clean air filter element (more frequently for vehicle operating in severe condition).	15K / 12M				•		•		•		•		•		•		•		•		•		•
2	Change engine oil and Oil filter	15K / 12M				•		•		•		•		•		•		•		•		•		•
3	Gasoline - Replace Gasoline Fuel Filter.	75K / 60M												•										•
4	Change Spark plugs	30K / 24M						•				•				•				•				•
5	Check accessory belt condition visually, replace if found damage.	15K / 12M				•		•		•		•		•		•		•		•		•		•
6	Replace air filter element (more frequently for vehicle operating in severe condition).	45K / 36M								•						•						•		
7	Change coolant	# 60K / 36M										•								•				
	Transaxle																							
1	Replace Trans-axle oil	75K / 60M												•										•

- Kms or months whichever occurs earlier

MAINTENANCE

Sr. No.	Operation	Kms	PDI	1.5K	7.5K	15K	22.5K	30K	37.5K	45K	52.5K	60K	67.5K	75K	82.5K	90K	97.5K	105K	112.5K	120K	127.5K	135K	142.5K	150K		
		Months	0	2	6	12	18	24	30	36	42	48	54	60	66	72	78	84	90	96	102	108	114	120		
Brakes																										
1	Check front brake pads & rear brake linings. Replace if necessary.	15K / 12M				•		•		•		•		•		•		•		•		•		•		
2	Replace brake fluid Check brake system components for Leakages.	# 45K / 24M								•						•							•			
3	Inspect & if necessary adjust handbrake setting.	15K / 12M				•		•		•		•		•		•		•		•		•		•		
Wheels & Tyres																										
1	Check & adjust wheel alignment.	# 15K / 18M				•		•		•		•		•		•		•		•		•		•		
2	Check for Tyre pressure, condition & rotate.	# 7.5K / 12M			•	•	•	•	•	•	•	•	•	•	•	•	•	•	•	•	•	•	•	•	•	

- Kms or months whichever occurs earlier

MAINTENANCE

Sr. No.	Operation	Kms	PDI	1.5K	7.5K	15K	22.5K	30K	37.5K	45K	52.5K	60K	67.5K	75K	82.5K	90K	97.5K	105K	112.5K	120K	127.5K	135K	142.5K	150K	
		Months	0	2	6	12	18	24	30	36	42	48	54	60	66	72	78	84	90	96	102	108	114	120	
	Electrical																								
1	Check specific gravity of battery electrolyte	7.5K/6M			•	•	•	•	•	•	•	•	•	•	•	•	•	•	•	•	•	•	•	•	•
2	Check headlamp focussing	15K / 12M				•		•		•		•		•		•		•		•		•		•	
	A.C. System																								
1	Check Air-conditioning / HVAC System for satisfactory performance also Inspect Polan filter	Every Service	•	•	•	•	•	•	•	•	•	•	•	•	•	•	•	•	•	•	•	•	•	•	•
2	Replace AC filter (Polan filter).	15K / 12M				•		•		•		•		•		•		•		•		•		•	
	AMT kit oil (Petrol & Diesel)																								
1	Check AMT Kit oil level, it should be in between min. & Max. level when the vehicle is in standstill and ignition ON condition. Top up AMT kit oil if necessary.	Every Service	•	•	•	•	•	•	•	•	•	•	•	•	•	•	•	•	•	•	•	•	•	•	•

- Kms or months whichever occurs earlier

MAINTENANCE

Vehicle Parking for Long Duration (Non - Use Maintenance)

If you want to park your vehicle at one place for long duration, following care is to be taken:

1. Park the vehicle in covered, dry and if possible well-ventilated premises. Engage a gear.
2. Remove the battery terminal cables (first remove the cable from the negative terminal). Ensure that battery is fully charged.
3. Use wheel chocks to prevent movement of the car.
4. Clean and protect the painted parts using protective wax.
5. Clean and protect the shiny metal parts using commercially available special compounds.
6. Sprinkle talcum powder on the rubber windscreen wiper and lift them off the glass.
7. Slightly open the windows.
8. Cover the vehicle with a cloth or perforated plastic sheet. Do not use sheets of imperforated plastic as they do not allow moisture on the vehicle body to evaporate.
9. Inflate the tyres to 0.5 bar above the normal specified pressure and check it at regular intervals.
10. Check the battery charge every six weeks.
11. Do not drain the engine cooling system.

Fuel Specification**Fuel (Diesel)**

Normal grade BS VI compliant diesel conforming to IS1460 :2017 or equivalent is recommended to be used as fuel.

Do not use premium diesel available in the market for like extra premium / Turbojet etc.

Recommended fuel specifications

Parameter	Unit	BS VI
Cetane Number (min)	CN	51
Sulphur content	mg/kg	10
Lubricity (HFRR)	micron	460

NOTE

Where oxidation catalytic converter is fitted, it is mandatory to use Diesel fuel with sulphur contents as given above. Use of any other diesel fuel can increase the pollutants.

Fuel (Petrol)

Unleaded gasoline conforming to IS 2796:2017 is recommended to be used as fuel. It is always recommended to use correct fuel to get optimum emission performance.

NOTE

Always use petrol of a correct specification in a vehicle fitted with catalytic converter. Even single fill of leaded petrol will seriously damage the catalytic converter.

TECHNICAL INFORMATION

Lubricant Specification

Use following genuine fluids, coolants and lubricants recommended for optimum performance of your vehicle.

Item	Specification	Company	Brand	Qty.
Engine Oil	0W20 SS6588	CASTROL	GTX T 0W20	3.5 Litres (Petrol) 5 Litres (Diesel)
		EXXON Mobil	Mobil Super 3000 TM 0W20	
		PETRONAS	PETRONAS Syntium 7000 TM 0W20	
Coolant (Pre-mixed) (Antifreeze agent +Soft water 40:60 ratio)	Class II/JIS K2234 TATA SS7700S1	Ansysco	Puroblue	5.5 Litres (Petrol) 6.5 Litres (Diesel)
		SUNSTAR CCI	Golden Cruiser LLC 2200NP	
		IOCL	TATA MOTORS GENUINE COOLANT KOOL PLUS	
Transaxle Oil	EP80WLL (Next Gen) TATA SS6582	CASTROL	Next Generation Transmission oil EP80W	2.4 Litres
		PETRONAS	PETRONAS TATA MOTORS Genuine -Gear oil New Gen 80 EP LL	
		IOCL	IOCL TATA MOTORS Genuine gear oil 80 WLL	
AMT Kit Oil	Hydraulic oil	PETRONAS	TUTELA Cs-Speed	As required
Brake Fluid / Clutch fluid	SAE J 1703, DOT 4	PETRONAS	Tutela Brake fluid DOT 4	As required
		Sunstar CCI	Golden Cruiser Tata Genuine Brake Fluid (DOT4)	
		CASTROL	Optional - CASTROL – Universal Brake Fluid DOT 4	
Refrigerant	R-134a	-		500±20 gms
Compressor Oil	SP10	Sandan Vikas	SP10	120±15 CC

TECHNICAL INFORMATION

Technical Specifications

Parameter	Diesel	Petrol
Engine		
Model/type	1.5 L CR05 MT/AMT BSVI	REVOTRON 1.2 L TCIC BSVI
Capacity	1497 cc	1199 cc
Max. Engine output	81 kW @ 4000 RPM	88.2 KW @ 5500 RPM
Max. Torque	260 Nm @ 1500 -2750 RPM	170 Nm @ 1750-4000 rpm
Clutch		
Type	Dry, Single Plate	
Outside diameter of clutch	228 dia	
Transaxle		
Model	TA 6300 MT/AMT	
Type	Synchromesh with overdrive	
No. Of gears	6 forward and 1 reverse	
Steering		
Type	Column mounted EPAS	
Brakes		
Brakes	Front Disc Brake ; Rear Drum Brake , Dia. 200	
Parking brake	Cable operated Mechanical	

TECHNICAL INFORMATION

Parameter	Diesel	Petrol
Suspension		
Type	Mcpherson strut	
Shock absorber	Front: Independent; lower wishbone; McPherson strut with coil spring Semi Independent Twist beam with coil spring and shock absorber	
Wheels & tyre		
Tyres	Option I: 195/60 R16 (Radial -Tubeless) Option II: 215/60 R16 (Radial -Tubeless)	
Wheel rims	Option I: 6J X 16 steel wheel Option II: 6.5J X16 Alloy wheel	
Fuel tank		
Capacity	44 liters	
Cab / body		
Type	Monocoque	
Electrical system		
System voltage	12 Volts (-ve earth)	12 Volts (-ve earth)
Alternator capacity	110 Amp	110 Amp
Battery	12V DIN 52	12V DIN 47

TECHNICAL INFORMATION

Parameter	Diesel	Petrol
Main chassis dimension (in mm)		
Wheel base	2498	2498
Track front	1540	1540
Track rear	1530	1530
Overall length	3993	3993
Overall height	1606	1606
Max. Width	1811	1811
Ground clearance	174	
Performance		
Max. Speed	160 kmph	
Max. Recommended gradeability	16.7 Deg	
Minimum Turning Circle Dia. in meter as per IS:12222	10.2 m	10.2 m
Minimum Turning Clearance circle dia. in meters as per IS:12222	10.8 m	10.8 m
Weight (in kg)		
Gross vehicle weight (Laden)	1677-1725	1590-1665
Kerb weight (unladen)	1267-1315	1179-1255

TECHNICAL INFORMATION

Vehicle Dimensions

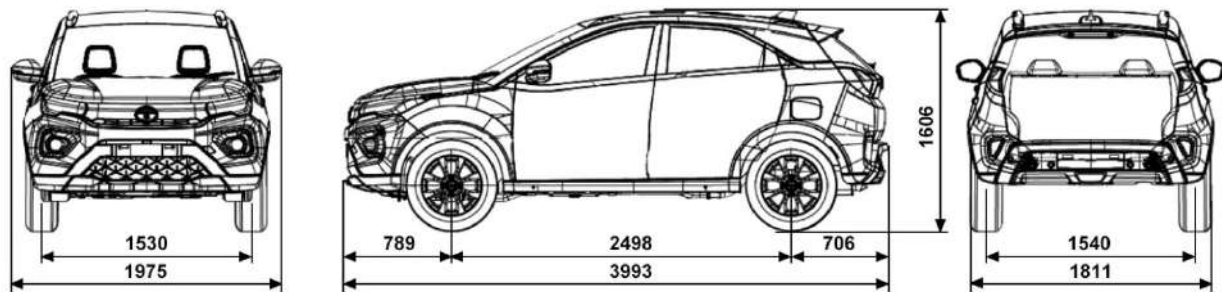

NOTE: Dimensions are in mm unladen condition

Aggregate Identification Numbers

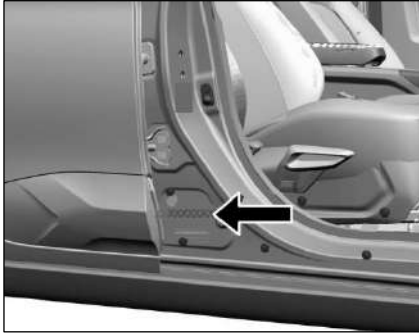

Chassis No. punching near driver seat

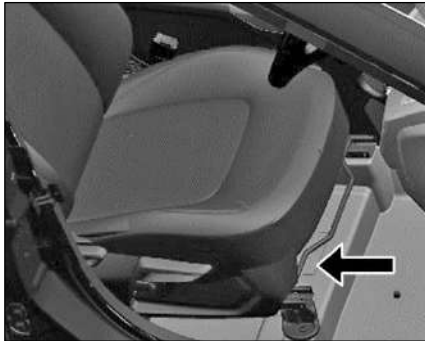

VIN plate below driver seat

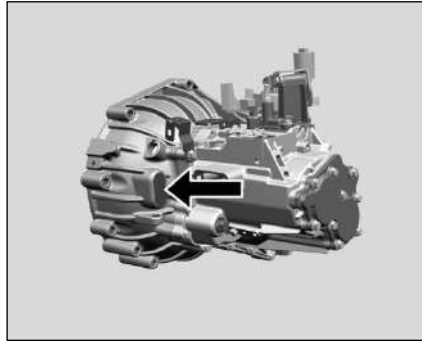

Transaxle No. Punching

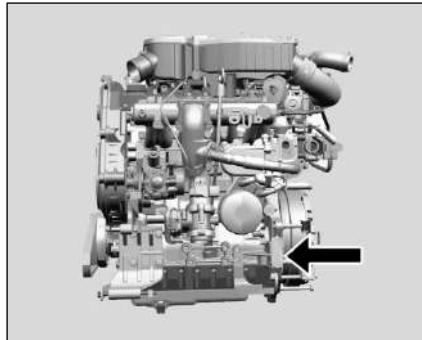

Engine No. Plate - Diesel

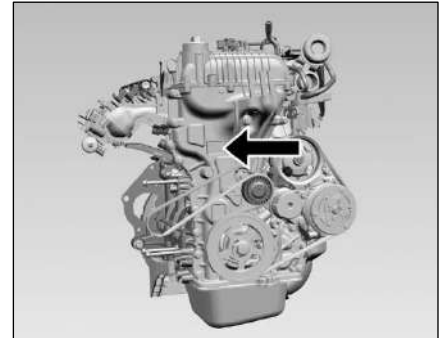

Engine No. Plate - Petrol

Car Care

Your vehicle is subjected to many external influences such as climate, road conditions, industrial pollution and proximity to the sea. These conditions demand regular care of the vehicle body. Dirt, insects, bird droppings, oil, grease, fuel and stone chippings should be removed as soon as possible.

Washing

Following these tips while washing your vehicle.

1. Always wash your vehicle in shade and the surface is at room temperature.
2. Wash with mild vehicle wash soap like 'Car Shampoo' and use a soft bristle brush, sponge or soft cloth and rinse it frequently while washing to avoid scratches.
3. To avoid scratches, please wear soft gloves. Remove finger rings, nails, wrist watch while washing.

4. To remove stubborn stains and contaminants like tar, use turpentine or cleaners like 'Stain remover' which are safe for paint surfaces.
5. Avoid substances like petrol, diesel, kerosene, benzene, thinner, acids or other solvents that cause damage to paint.
6. Dry your vehicle thoroughly to prevent any damp spots.
7. Rinse all surfaces thoroughly to prevent any traces of soap and other cleaners as this may lead to the formation of stains on the painted surface later.

NOTE

Avoid parking the car under trees without proper cover, it will reduce the amount of bird droppings, tree sap and pollen contact on paint surface. Regularly remove the twigs, leaves and vegetation near the windshield areas, to avoid water stagnation.

WARNING

Do not direct high pressure washer fluid/ water jets (Pressure above 0.5 Bar) at electrical devices and connector during washing. This is to prevent malfunction / failure of electrical system due to water ingress.

After drying the vehicle, inspect it for chips and scratches that could allow corrosion to start. Apply touch up paint where necessary.

Cleaning of Carpets

Vacuum clean the carpet regularly to remove dirt. Dirt will make the carpet wear out faster. Periodically shampoo the carpet to keep it looking new.

Use carpet cleaners (preferably foam type). Follow the instructions that come with the cleaner. Apply it with a sponge or soft brush. Keep the carpeting as dry as possible by not adding water to the foam.

CAR CARE AND VALUE ADDED SERVICES

NOTE

Avoid wiping of painted surface in dry condition as it may leave scratches on the painted surface.

Cleaning of Windows, Front and Rear Glasses

Clean the windows inside and outside with commercially available glass cleaners.

This will remove the haze that builds up on the inside of windows. Use a soft cloth or paper towels to clean all glass and plastic surfaces.

FAST TAG

FAST TAG is pasted on front windshield from the inside. It enables Electronic toll collection.



NOTE

Do not attempt to rip or tamper the tag. It will disable the functionality of the tag.

Waxing

Waxing and polishing is recommended to maintain the gloss and wet-look appearance of your paint finish.

1. Use good quality polish and wax for your vehicle.
2. Re-wax your vehicle when the water does not slip off the surface but collects over the surface in patches.

Polishing

Polishes and cleaners can restore shine to the painted surface that has oxidized and become dull. They normally contain mild abrasives and solvents that remove the top layer of the finish coat. Polish your vehicle, if the finish does not regain its original shine after using wax.

Interior fabric cleaning tips

1. Stains should be treated immediately. If left for a long time, they can leave a permanent mark.
2. Cleaning the stains immediately is important especially for stains which contain artificial colors in the stain creating liquid or semisolid substance. The colorant may leave a stain if kept for longer time.
3. Stain should not be removed by rubbing. As far as possible, try to blot or lift the stain with cloth or plastic spatula and then clean the remaining stain with cloth or sponge.

CAR CARE AND VALUE ADDED SERVICES

4. If the stain has dried, then gently brush off the material and then press with damp cloth or sponge till it disappears.
5. Do not use household detergents to clean the fabric.
6. Always use clean cotton cloth for cleaning.

Paint Care

Following guidelines will help you to protect your Vehicle from corrosion effectively.

NOTE

Avoid spillage or direct contact of air freshener liquid/ chemicals to interior painted plastic parts. These chemicals may cause damage to paint like blisters, peel off, wrinkles etc.

Proper cleaning

In order to protect your vehicle from corrosion it is recommended that you wash your vehicle thoroughly and frequently in case:

- There is a heavy accumulation of dirt and mud especially on the underbody.
- It is driven in areas having high atmospheric pollution due to smoke, soot, dust, iron dust and other chemical pollutants.
- It is driven in coastal areas.
- The underbody must be thoroughly pressure washed after every three months.

In addition to regularly washing your car, the following precautions need to be taken.

Periodic Inspection

- Regularly inspect your vehicle for any damage in the paint film such as deep scratches and immediately get them repaired from an authorized service outlet, as these defects tend to accelerate corrosion.
- Inspect mud liners for damages.
- Keep all drain holes clear from clogging.

Proper Parking

- Always park your vehicle in shade to protect it from harsh sunlight or in a well-ventilated garage so that there is no dampness on any part of the vehicle.

Wiper care

- To prevent damage to the wipers or windshield, do not operate the wipers when the windshield is dry.
- To prevent damage to the wiper arms and other components, do not attempt to move the wipers manually.

CAR CARE AND VALUE ADDED SERVICES

Value Care – AMC

Value Care (AMC) is a fixed cost maintenance plan that guarantees protection against unexpected repairs & provides substantial savings through protection against inflation & price volatility of consumables during the running of the vehicle.

Our customers can choose from **Value Care Gold, Value Care Silver, Promise to Protect (P2P) and Protect plus** plan as per the requirement & usage to ensure hassle free, reliable & economic maintenance of the vehicle.

Coverage – **Schedule Service and Wear & tear.**

Advantage (Customer Benefits)

- Price protection against rising prices of lubes and parts.
- A higher resale value for your vehicle
- Peace of mind with Cashless repairs & services.
- Vehicle servicing at a workshop of your choice pan India
- Covers Repairs including Wear & Tear parts viz. Brakes, Suspension, Wiper, Clutch, Brake Pads, Brake Liners etc.
- Covers Scheduled maintenance services including Lubricants, Parts, Wheel Alignment and Balancing Labour.
- Available at unmatched value.....Huge Savings!!!
- Savings on Goods & Services Tax whenever vehicle attend under AMC.



Available offers (Types of AMC)

- Silver AMC
- Gold AMC
- Promise to Protect (P2P)
- Protect Plus

Silver AMC -

Value Care Silver Plan covers the following:

- Scheduled maintenance services at periodic interval of Kms for Labor, Parts & Consumables.
 - a. Change of Oil Filter, Fuel Filter, Air Filter & Sedimenter.
 - b. Change of Engine Oil, Transmission Oil.
 - c. Change of Coolant, Brake Oil & Clutch Fluid*.
 - d. General Checkup, Wheel Alignment / Balancing (Excluding Balancing Weight).
 - e. Washing of Vehicle, Wheel greasing as applicable.

Gold AMC -

The value care Gold Plan extends your scheduled maintenance cover to include any normal wear and tear items identified during the scheduled service and other vehicle parts that need to replace during the period of cover arising from proper and uniform usage.

- Scheduled maintenance services at periodic interval of Kms for Labor, Parts & Consumables.

CAR CARE AND VALUE ADDED SERVICES

In addition to coverage mentioned under Silver AMC, the Gold AMC also covers Repairs or Replacement of Wear & Tear Items for both Parts & Labour.

- a. Brake Pads, Brake Liners, Wheel Cylinders
- b. Clutch Disc, Clutch Cover, Cables, Mountings.
- c. Suspension Bush, Wiper Blades, Auxiliary Belt & other Wear & Tear Items
- d. Washing of Vehicle, Wheel greasing as applicable.

Promise to Protect (P2P) -

Value Care – Promise to protect (P2P) is a maintenance plan that guarantees protection against unexpected wear & tear repairs to provide substantial saving through protection against inflation & price volatility during the running of the vehicle.

New Vehicle (under warranty vehicles) are eligible to avail this offer – Identified 13 wear & tear parts listed below Including Labour is covered in this AMC with the price range of 11 to 14 paisa per Km . *applicable to selected models*

List of covered Parts- Clutch, Brake Pad, Brake Linings, Brake Disc, Wiper, Wheel Cylinder, Suspension Bushes, Engine Mountings, Ball Joints, Hoses, Auxiliary Belt, (Alternator & A/C Belt), Window Winder.

Protect Plus -

The value care Protect plus Plan extends your scheduled maintenance cover to include coverage of P2P. It covers Scheduled maintenance services – labour, parts & consumables + Identified 13 wear & tear parts of P2P plan Including Labour

New Vehicle (under warranty vehicles) are eligible to avail this offer. *applicable to selected models*.

CAR CARE AND VALUE ADDED SERVICES

NOTE

- *AMC is available in the dealership from where you have purchased your vehicle.*
- *We strongly recommend purchase of AMC at time of purchase of your vehicle to get benefit for coverage of Scheduled Services and Wear & Tear parts.*
- *The Dealer Service Marketing Executive shall explain to you the Terms and conditions, Coverage and Owner's responsibility.*
- *One Time payment is to be made to avail AMC offer.*
- *P2P & Protect plus offer valid on selected models & may vary from Model to Model, Variant to Variant.*
- *Please read the offer eBooklet for further details about coverage and exclusions of various AMCs.*
- **Terms & condition apply.*

Owner's Responsibility:

- Proper use, maintenance and care of the vehicle in accordance with the instructions contained in the Owner's Manual and Service Booklet. The records of the same to be ensured in Owner's Manual.
- Retention of maintenance service bills.

I / We have been explained the Terms and conditions, Coverage and Owner's responsibility by the Dealer Service Marketing Executive.

I wish to avail / Do not wish to avail Value care AMC policy.

Customer's Signature

Dealer's Signature

CAR CARE AND VALUE ADDED SERVICES

Extended Warranty

TATA MOTORS recommends the purchase of its extended warranty program.

Coverage - Mechanical + Electrical

Benefits

- Insures you against unforeseen break down repair bills.
- Documentation is simple and hassle free.
- Near cashless & speedy claim

Term

24 + 12 months or 75,000 kms whichever occurs first

OR

24 + 24 months or 1,00,000 kms whichever occurs first

OR

24 + 36 months or 1,25,000 kms whichever occurs first

Extended Warranty is available in the dealership from where you have purchased your vehicle. We strongly recommend purchase of Extended Warranty at time of purchase of your vehicle. Extended Warranty can be availed till warranty period from date of purchase of vehicle. The Dealer Service Marketing Executive shall explain to you the Terms and conditions, Coverage and Owner's responsibility.



CAR CARE AND VALUE ADDED SERVICES

- The 12 or 24 or 36 months extended warranty does not follow the 24 months Manufacturer's warranty.
- The extended warranty comes into force once the manufacturer's warranty expires e.g. after 24 Months.
- It is more restrictive as by the time it comes into force the vehicle is already 24 months old.

What is covered?

- Mechanical / Electrical break down as defined in this warranty and confirmed by the dealer within the stipulated terms and conditions.
- TATA MOTORS dealer shall either repair or replace any part found to be defective with a new part or an equivalent at no cost to the owner for parts or labour.
- Such defective parts which have been replaced will become property of TATA MOTORS LIMITED.
- Comprehensive list of parts covered is mentioned in the Extended Warranty Booklet.

What is not covered?

Please refer the Extended Warranty Booklet for details of the exclusion list. Soft copy of which will be provided by dealer.

Owner's Responsibility:

- Proper use, maintenance and care of the vehicle in accordance with the instructions contained in the Owner's Manual and Service Booklet. The records of the same to be ensured in Owner's Manual.
- Retention of maintenance service bills.

I / We have been explained the Terms and conditions, Coverage and Owner's responsibility by the Dealer Service Marketing Executive.

I wish to avail / Do not wish to avail extended warrant policy.

Customer's Signature

Dealer's Signature

CAR CARE AND VALUE ADDED SERVICES

Value Added Services

Why are Corrosion Protection Waxes necessary?

Corrosion is caused by:

Water/salt water, acid rain and atmospheric fallouts.

Critical areas are:

Cavities: joints, crevices, spot welds, underbody

- Corrosion is the most important factor when we talk about the vehicle life. If you treat your car well, you can prolong its life.
- It is very dangerous to drive around in a corroded vehicle.
- Corrosion creeps onto the vehicle internally and externally as well. The most dangerous kind of corrosion is often not discovered until it is too late.

Benefits of Anti - Rust treatment:

- A professionally applied range of world class products offering real value to the new and used vehicle customer.
- The treatment has been developed to withstand the harshest environmental and climatic conditions (rust. Pollutants, stone and gravel impact, etc.)
- Insulates the cabin from external noises..
- Expensive tin work, denting and painting can be avoided.
- Higher resale value for the vehicle.
- Higher safety – uncorroded vehicle
- 10 free checkups available



CAR CARE AND VALUE ADDED SERVICES

TATA MOTORS has tied up with **M/s Würth, M/s Autokrom, M/s 3M India Lt d & M/s Bardahl** for these world class treatment at affordable prices. These treatments are available in all authorized workshops. The Dealer Service Marketing Executive will explain to you the benefits and terms and conditions of this treatment.

I / We have been explained the Benefits, Terms and conditions and the prices of these treatments by the Dealer Service Marketing Executive.

I wish to avail / Do not wish to avail extended warrant policy.

Customer's Signature

Dealer's Signature

CAR CARE AND VALUE ADDED SERVICES

Vehicle Exterior Enrichment

Why vehicles are painted?

- For Corrosion protection of the metal surfaces.
- Ease of application from other corrosion protection treatments.
- Cheaper than other corrosion protection methods eg. Galvanizing, anodizing.
- For decoration and identification.

Various Environmental Hazards affecting paints

Environmental hazards: destroys your vehicle's finish.

Even as your new vehicle rolls off the assembly line, the paint is not protected.

The enemy

Ultraviolet rays, pollution, tree sap, bird droppings, car wash chemicals, road salt and acid rain.

Benefits: Vehicle Exterior Enrichment

- Removal of medium scratches, orange peel, oxidation, dust nibs etc. & swirl marks from painted surface.
- Restoration of original gloss levels, UV protection after gloss is restored.
- Cleaning & dressing of tyres, Bumpers and all exterior plastic moldings/trims.

TATA MOTORS has tied up with **M/s Autokrom**, **M/s 3M** & **M/s Wurth** for this world class treatment at affordable prices.

This treatment is available in all authorized workshops. The Dealer Service Marketing Executive will explain to you the benefits and terms and conditions of this treatment.



Vehicle Interior Enrichment

Why protect your new car's fabric interior?

- Someone may soil your vehicle's fabric carpet or seats.
- A significant detractor from your vehicle's resale value.
- A permanent stain on your vehicle's interior fabric.

The enemy:

Drink spills, food stains, mud, ultraviolet rays, traffic and pets

Benefits: Vehicle Interior Enrichment

- Removal of medium stains and dirt from all interior parts of the car i.e., carpet, upholstery and roof lining.
- Cleaning of windshield and all windows (inner and outer surfaces)
- Dressing of all internal plastics (e.g.: door pad trims) and rubber parts.
- The treatment involves cleaning and dressing of all parts of the exposed interiors.
- Specialised protection for seat fabric from liquid spills.

TATA MOTORS has tied up with **M/s Wurth** and **M/s Autokrom** for this world class treatment at affordable prices. This treatment is available in all authorized workshops. The Dealer Service Marketing Executive will explain to you the benefits and terms and conditions of this treatment.

I / We have been explained the Terms and conditions, Coverage and Owner's responsibility by the Dealer Service Marketing Executive.

I wish to avail / Do not wish to avail extended warrant policy.

Customer's Signature

Dealer's Signature

WARRANTY - TERMS AND CONDITIONS

We WARRANT each **TATA NEXON** vehicle and parts thereof manufactured by us to be free from defect in material and workmanship subject to the following terms and conditions:

1. This warranty shall be for a period of **24 months from the date of sale of the car or a mileage of 75,000 Kms whichever occurs earlier.**
2. Our obligation under this warranty shall be limited to repairing or replacing, free of charge, such parts of the car which, in our opinion, are defective, on the car being brought to us or to our dealers within the period. The parts so repaired or replaced shall also be warranted for quality and workmanship but such warranty shall be co-terminus with this original warranty.
3. Any part which is found to be defective and is replaced by us under the warranty shall be our property.
4. As for such parts as Tyres, Batteries, Audio and / or Video equipment (if any), etc. not manufactured by us but supplied by other parties, this warranty shall not apply, but buyers of the car shall be entitled to, so far as permissible by law, all such rights as we may have against such parties under their warranties in respect of such parts.
5. This warranty shall not apply if the car or any part thereof is repaired or altered otherwise than in accordance with our standard repair procedure or by any person other than from our sales or service establishments, our authorized dealers, service centres or service points in any way so as, in our judgment which shall be final and binding, to affect its reliability, nor shall it apply if, in our opinion which shall be final and binding, the car is subjected to misuse, negligence, improper or inadequate maintenance or accident or loading in excess of such carrying capacity as certified by us, or such services as prescribed in our Owner's Manual are not carried out by the buyer through our sales or service establishments, our authorized dealers, service centres or service points.
6. **This warranty shall not apply to the replacement of normal wear parts, including without limitation, spark plugs, drive belts, hoses, wiper blades, fuses, clutch disc, brake shoes, brake pads, cables and all rubber parts (except oil seal and glass run).**
7. This warranty shall not cover any inherent normal deterioration of the car or any of its parts arising from the actual use of the car or any damage due to negligent or improper operation or storage of the car.
8. This warranty shall not apply to normal maintenance services like oils & fluid changes, head lamps focusing, fastener retightening, wheel balancing and alignment, tyre rotation, adjustment of valve clearance, fuel timing, ignition timing and consumables like bulbs, fuel, air & oil filters and gas leaks in case of air conditioned cars.
9. This warranty shall not apply to any damage or deterioration caused by environmental pollution or bird droppings. Slight irregularities not recognized as affecting the function

WARRANTY - TERMS AND CONDITIONS

- or quality of the vehicle or parts, such as slight noise or vibration, defects appearing only under particular or irregular operations are items considered characteristics of the vehicle.
10. This warranty shall be null and void if the car is subjected to abnormal use such as rallying, racing or participation in any other competitive sport. This warranty shall not apply to any repair or replacements as a result of accident or collision.
 11. This warranty is expressly in lieu of all warranties, whether by law or otherwise, expressed or implied, and all other obligations or liabilities on our part and we neither assume, nor authorize any person to assume on our behalf, any other liability arising from the sale of the car or any agreement in relation thereto.
 12. The buyer shall have no other rights except those set out above and have, in particular, no right to repudiate the sale, or any agreement or to claim any reduction in the purchase price of the car, or to demand any damages or compensation for losses, incidental or indirect, or inconvenience or consequential damages, loss of car, or loss of time, or otherwise, incurred or accrued.
 13. Any claim arising from this warranty shall be recognized only if it is notified in writing to us or to our authorized dealer without any delay soon after such defects as covered & ascertained under this warranty.
 14. **This warranty is fully transferable to subsequent vehicle owner. Only unexpired remaining period of warranty applies.**
 15. We reserve our rights to make any change or modification in design of the car or its parts or to introduce any improvement therein or to incorporate in the car any additional part or accessory at any time without incurring any obligation to incorporate the same in the cars previously sold.

TATA MOTORS LTD. is committed to produce vehicles using environmentally sustainable technology. A number of features have been incorporated in TATA MOTORS passenger vehicles which have been designed to ensure environmental compatibility throughout the life cycle of the vehicle. We would like to inform you that your vehicle meets emission norms and this is being regularly validated at the manufacturing stages.

As a user you too can protect the environment by operating your vehicle in a proactive manner. A lot depends on your driving style and the way you maintain your vehicle. We have given a few tips for your guidance.

Driving

- Avoid frequent and violent acceleration.
- Do not carry any unnecessary weight in the vehicle as it overloads the engine. Avoid using devices requiring high power consumption during slow city traffic condition.
- Monitor the vehicle's fuel consumption regularly and if showing rising trend get the car immediately attended at the Company's Authorised Service Outlets.
- Switch off the engine during long stops at traffic jams or signals. If you need to keep the engine running, avoid unnecessary revving it up or stopping and starting.
- It is not necessary to rev up the engine before turning it off as it unnecessarily burns the fuel.

- Shift to higher gears as soon as it is possible. Use each gear upto 2/3rd of its maximum engine speed.
- A chart indicating gear shifting speeds is given in this book.

Maintenance

- Ensure that recommended maintenance is carried out on the vehicle regularly at the Authorised Service Outlets.
- As soon as you see any leakages of oil or fuel in the vehicle we recommend to get it attended immediately.
- Use only recommended grades and specified quantity of lubricants.
- Get your vehicle checked for emission periodically by an authorised dealer.
- Ensure that fuel filter, oil filter and breather are checked periodically and replaced, if required, as recommended by TATA MOTORS.
- Do not pour used oils or coolants into the sewage drains, garden soil or open streams. Dispose the used filters and batteries in compliance with the current legislation.
- Do not allow unauthorized person to tamper with engine settings or to carry modifications on the vehicle.
- Never allow the vehicle to run out of fuel.
- Parts like brake liners, clutch discs should be vacuum cleaned. Do not use compressed air for cleaning these parts which may spread dust in the atmosphere.

ENVIRONMENT SAFETY

While carrying out servicing or repairs of your vehicle, you should pay keen attention to some of the important engine aggregates and wiring harness which greatly affect emission. These components are:

For Diesel:

1. Fuel injection equipment- pump, rail, injectors, nozzles and high-pressure pipes.
2. Air Intake & Exhaust system, especially for leakages.
3. Cylinder head for valve leakage.
4. All filters such as air, oil and fuel filters (check periodically).
5. Turbocharger.
6. EGR Valve & Cooler
7. Intake throttle
8. Electrical connections.
9. If the 'Check Engine lamp', 'MIL' or 'DPF' lamp continuously glows, please take the vehicle to a TATA MOTORS Authorized Dealer/Service Center.
10. Catalytic Converter.(LNT - Lean NOx trap & DPF for Diesel)
11. EMS wiring harness i.e. electrical connections to all sensors and actuators.

For Petrol:

1. Engine Management System (EMS)
 - ECU
 - EMS sensors & Corresponding wiring harness
 - Electrical connections to all sensors & actuators
2. Fuel Injection System
 - Fuel Pump
 - Fuel filter
 - Fuel Injectors
3. Air intake System
 - Air filter & connecting pipes
4. Exhaust after Treatment System
 - Catalytic Converter
5. Ignition System
 - Ignition coil
 - Spark plug

This Owner's manual contains further information on driving precautions and maintenance care leading to environment protection. Please familiarize yourself with these aspects before driving.

ALL NEW
NEXON



TATA MOTORS | SERVICE
RESPONSIVE. RELIABLE. BEST VALUE

Call us: 1-800-209-7979 | Mail us: customercare@tatamotors.com | Visit us: service.tatamotors.com

5438 5840 99 05

Developed by: Technical Literature Cell, ERC.