

Front view

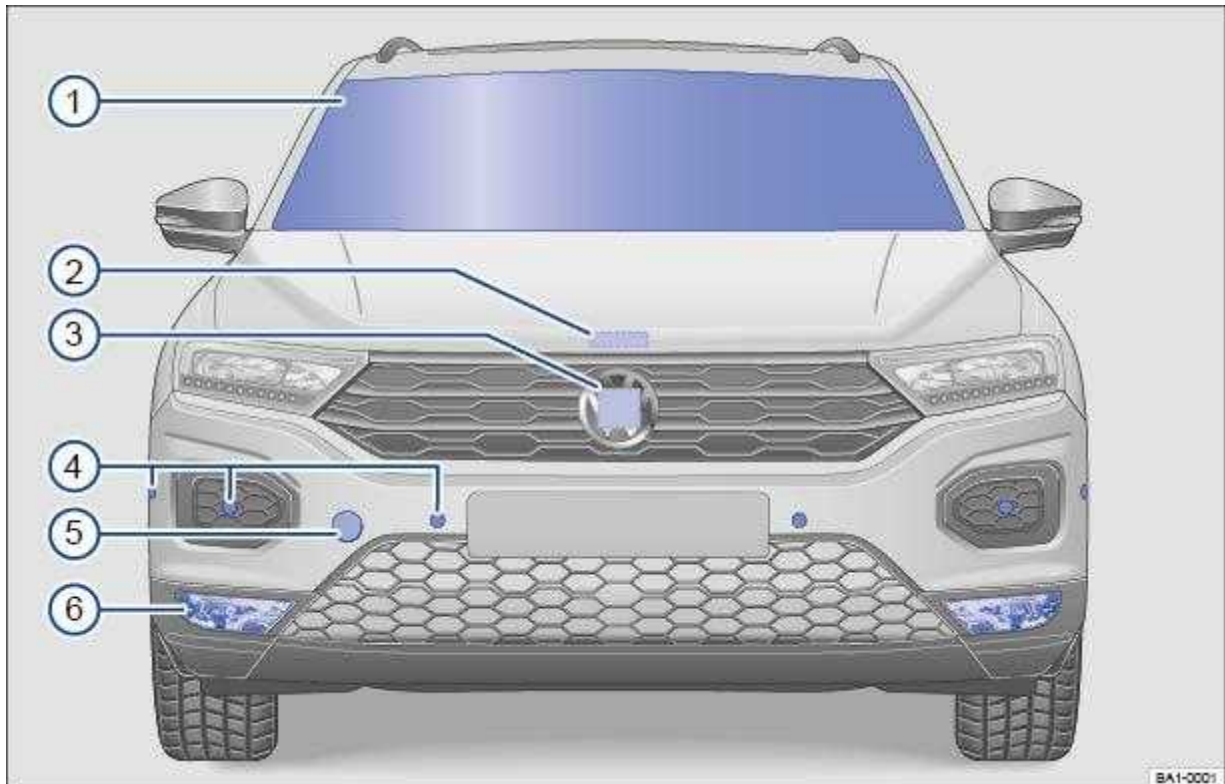

Fig. 2 Front view of the vehicle.

Key to ⇒ Fig. 2 :

①

Windscreen:

Vehicle identification number ⇒ Technical data

Windscreen wipers ⇒ Wipers ⇒ Wiper blades

Rain/light sensor in the area of the interior mirror ⇒ Rain/light sensor ⇒ Caring for and cleaning the vehicle exterior

Sensor for lighting functions ⇒ Light functions ⇒ Caring for and cleaning the vehicle exterior

②

Bonnet opening lever ⇒ In the engine compartment

③

Behind the Volkswagen badge: radar sensor for assist systems ⇒ Caring for and cleaning the vehicle exterior

④

Sensors for assist systems ⇒ Caring for and cleaning the vehicle exterior ⇒ Driver assist systems

⑤

Behind a cover: mounting for towing eye ⇒ Tow-starting or towing

⑥

Lights in the bumper ⇒ Lights ⇒ Changing bulbs

Side view

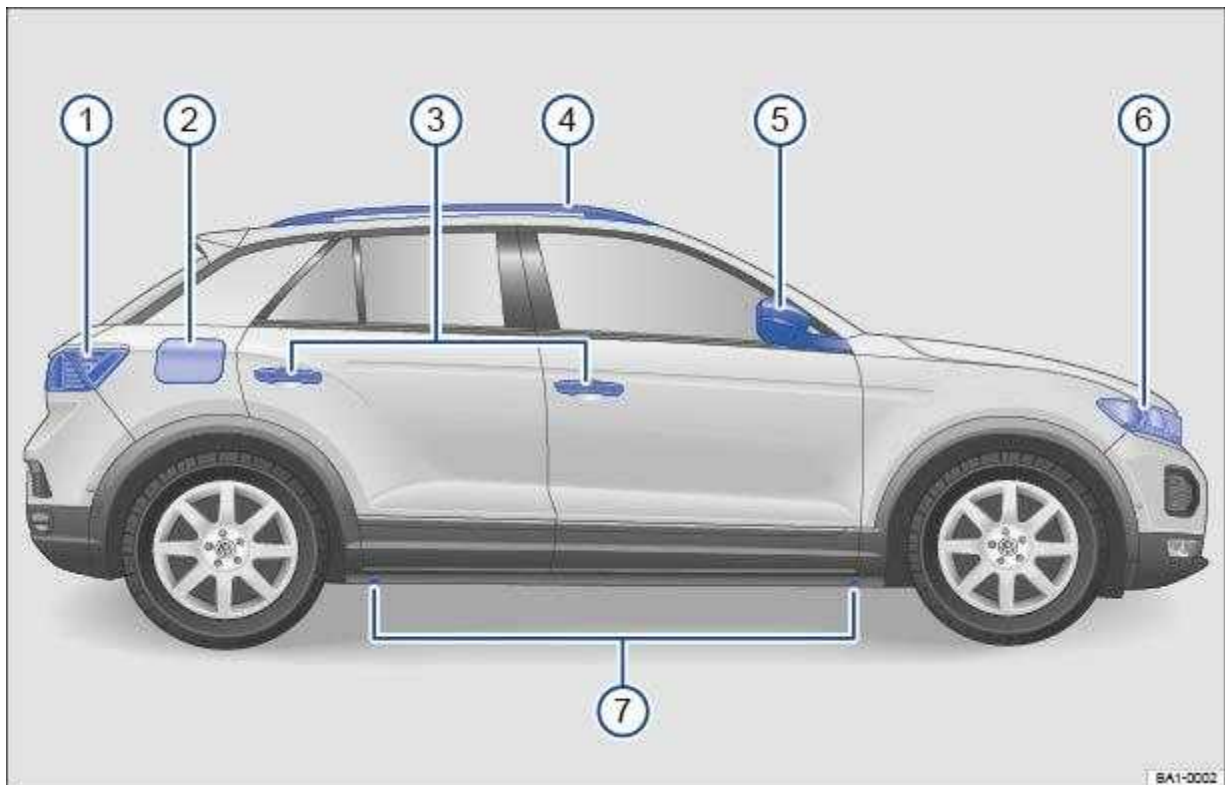

Fig. 3 Overview of the right side of the vehicle.

Key to ⇒ Fig. 3 :

- ① Tail light cluster ⇒ Lights ⇒ Changing bulbs
- ② Tank flap ⇒ Fuel and emission control
- ③ Door release lever ⇒ Doors and central locking button
- ④ Roof railing ⇒ Roof carrier
- ⑤ Exterior mirror ⇒ Exterior mirrors
- ⑥ Headlights ⇒ Lights
- ⑦ Lifting points for the jack ⇒ Changing a wheel

Rear view

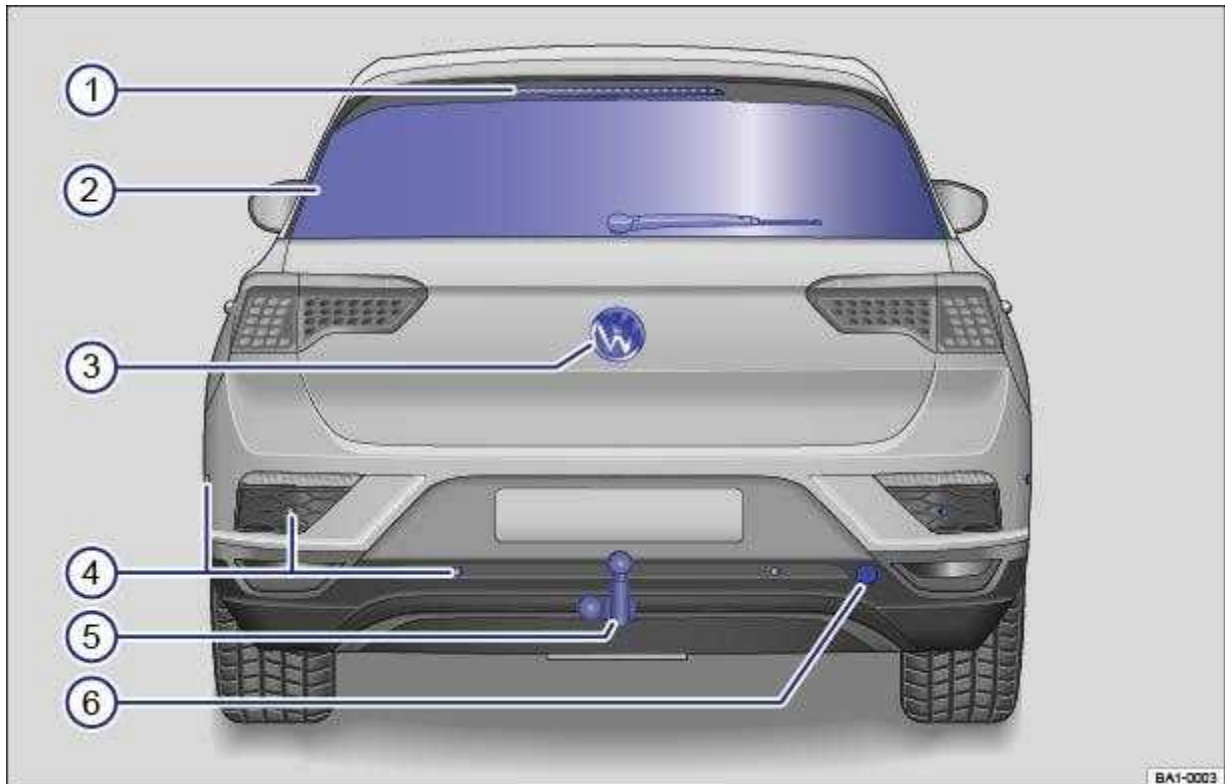

Fig. 4 Overview of the rear of the vehicle.

Key to ⇒ Fig. 4 :

① High-level brake light

②

Rear window:

Rear window heating ⇒ Heating and air conditioning system

Rear window wiper ⇒ Wipers ⇒ Wiper blades

③

Volkswagen badge:

To open the boot lid ⇒ Opening and closing the boot lid

With camera for assist systems ⇒ Driver assist systems

④ Sensors for assist systems ⇒ Caring for and cleaning the vehicle exterior

⑤ Towing bracket ⇒ Trailer towing

⑥ Behind a cover: mounting for towing eye ⇒ Tow-starting or towing

Driver door

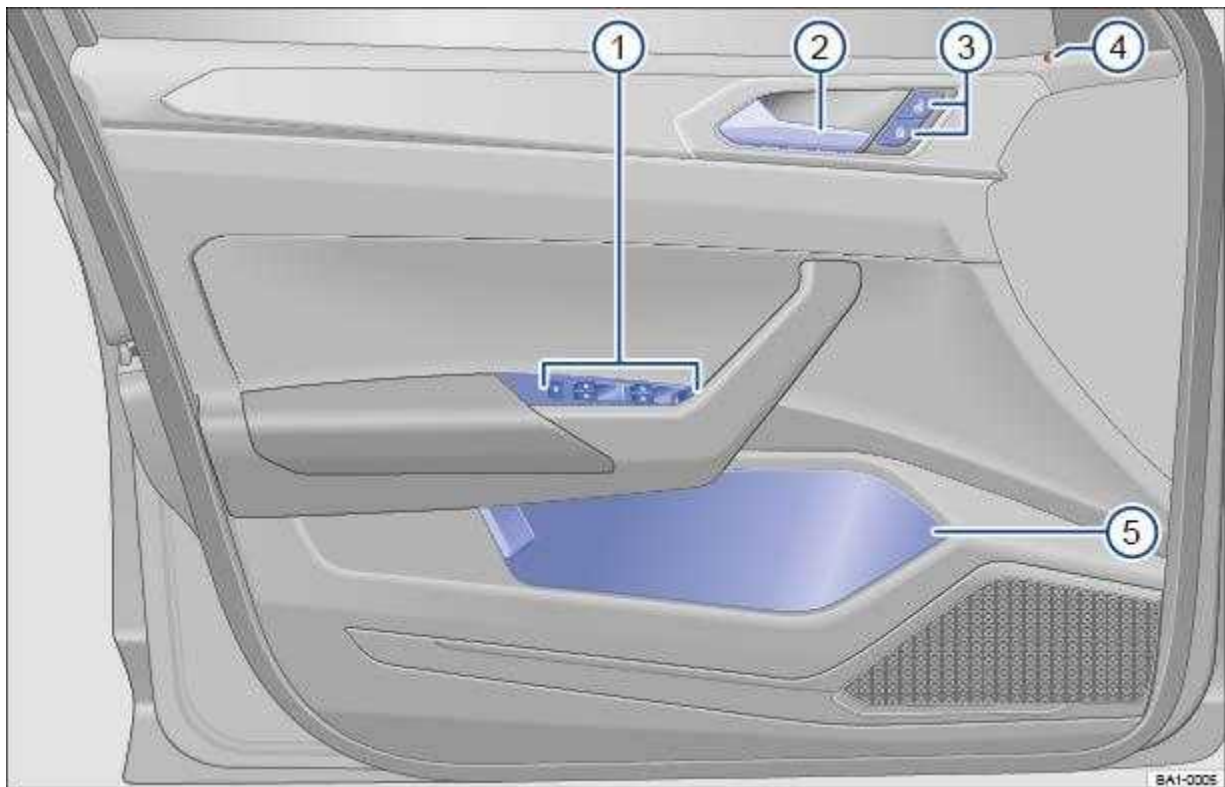

Fig. 5 Controls in the driver door (left-hand drive vehicle). The location is mirrored in right-hand drive vehicles.

Key to ⇒ Fig. 5 :

①

Area:

Switch for exterior mirror adjustment and heating ⇒ Exterior mirrors

Buttons for operating the electric windows ⇒ Windows

②

Door release lever ⇒ Doors and central locking button

③

Central locking button for locking and unlocking the vehicle ⇒ Central locking button

④

Central locking indicator lamp ⇒ Indicator lamp in the driver door

⑤

Stowage compartment ⇒ Stowage areas

Driver side

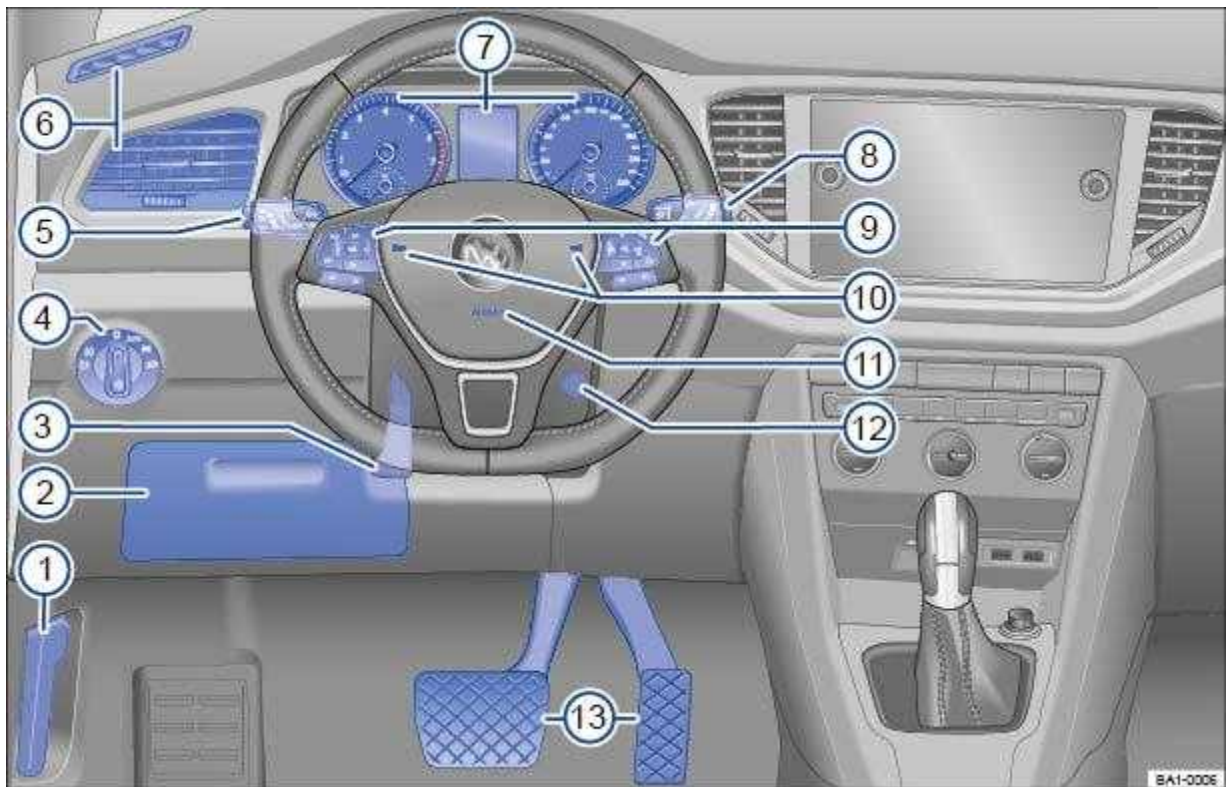

Fig. 6 Overview of the driver side (left-hand drive vehicles).

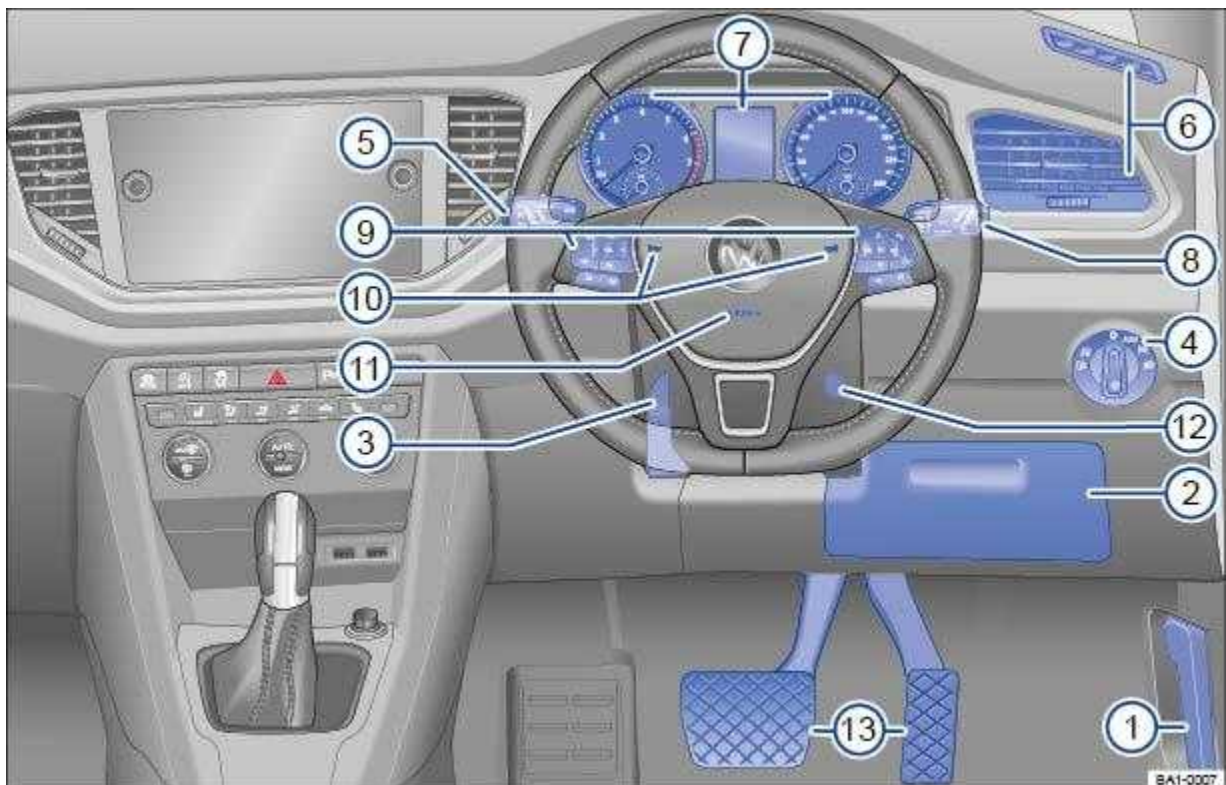

Fig. 7 Overview of the driver side (right-hand drive vehicles).

Key to ⇒ Fig. 6 and ⇒ Fig. 7 :

① Bonnet release lever ⇒ In the engine compartment

② Fuse box cover ⇒ Changing fuses

③ Lever for adjusting the steering column position ⇒ Steering wheel

④ Light switch ⇒ Vehicle lighting

⑤

Turn signal and main beam lever ⇒ Vehicle lighting

With switches and buttons for the driver assist systems ⇒ Button for driver assist systems ⇒ Driver assist systems

⑥ Vents ⇒ Heating and air conditioning system

⑦

Instrument cluster ⇒ Instrument cluster

With warning and indicator lamps ⇒ Symbols in instrument cluster

⑧

Lever for wipers and washers ⇒ Wipers

With buttons for operating the menus ⇒ Instrument cluster

⑨

Controls on the multifunction steering wheel:

Operating driver assist systems ⇒ Operating using the multifunction steering wheel ⇒ Driver assist systems

Audio, navigation 

Opening the telephone menu or accepting telephone calls 

Volume adjustment 

Activating voice control  (no function in some models)

⑩ Horn

⑪ Location of the driver front airbag ⇒ Airbag system

⑫ Ignition lock ⇒ Starting and stopping the engine

⑬ Pedals ⇒ Pedals

Centre console



Fig. 8 Overview of the upper section of the centre console.

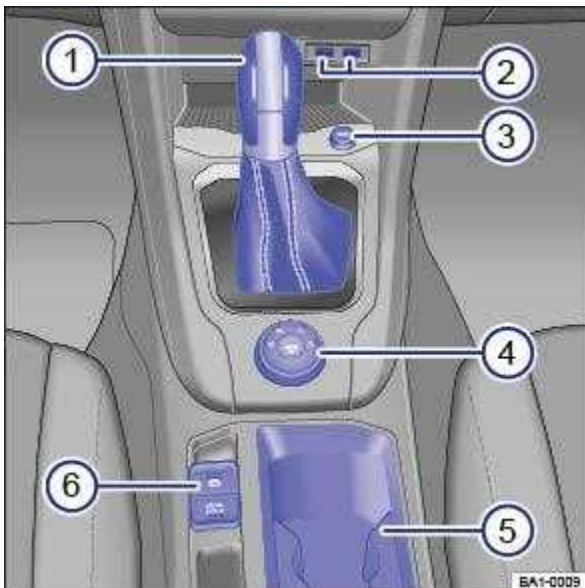

Fig. 9 Overview of the lower section of the centre console.

Key to ⇒ Fig. 8 :

① Infotainment system ⇒ Booklet Infotainment system, ⇒ Infotainment system controls and displays

② Vents ⇒ Heating and air conditioning system

③

Buttons:

Hazard warning lights  ⇒ In an emergency

Indicator lamp for the front passenger front airbag switch-off function **OFF**  ⇒ Airbag system

Driver assist systems ⇒ Driver assist systems

 Controls for the air conditioning system, heating and fresh air system ⇒ Heating, ventilating, cooling

 Controls for the air conditioning system, heating and fresh air system ⇒ Heating, ventilating, cooling

Key to ⇒ Fig. 9 :





Lever:

DSG® dual clutch gearbox ⇒ DSG® dual clutch gearbox

Manual gearbox ⇒ Manual gearbox: selecting a gear

 Multimedia connections ⇒ Booklet Infotainment system, .

 Cigarette lighter or 12-volt socket ⇒ Ashtray and cigarette lighter ⇒ Electrical sockets

 Control for the 4MOTION Active Control ⇒ Driving profile selection and 4MOTION Active Control

 Stowage compartment with drink holder ⇒ Stowage areas



Buttons:

Electronic parking brake ⇒ Electronic parking brake

Auto Hold function ⇒ Auto Hold function

Front passenger side

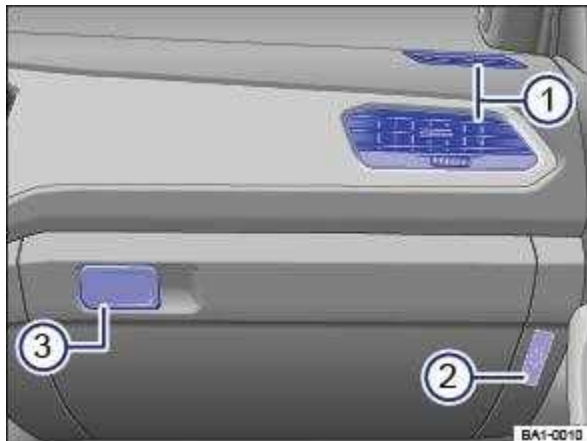

Fig. 10 Overview of the front passenger side (left-hand drive vehicles). The location is mirrored in right-hand drive vehicles.

Key to ⇒ Fig. 10 :

- ① Vents ⇒ Heating and air conditioning system
- ② At the side of the dash panel: key-operated switch for disabling the front passenger front airbag ⇒ Airbag system
- ③ Operating lever for the stowage compartment ⇒ Stowage areas

Controls in the roof

Symbol	Meaning
	Buttons for interior and reading lights ⇒ Interior lighting .
	Switch for glass roof ⇒ Glass roof .
	Buttons for the sun blind ⇒ Protection from the sun .
	Buttons for emergency call service, information call and breakdown call ⇒ In an emergency

Driver information

























Symbols in instrument cluster

























The warning and indicator lamps indicate various warnings, faults or certain functions. Some warning and indicator lamps light up when the ignition is switched on and must go out once the engine is running or the vehicle is in motion.



















Depending on the vehicle equipment level, symbols may be displayed in the instrument cluster instead of warning lamps.

Not all warning and indicator lamps are available in all markets.



Indicator lamps which light up in the light switch are described in the chapter Lights ⇒ Lights .

Symbol	Meaning
	Central warning lamp. Observe the additional information on the instrument cluster display.
	Electronic parking brake ⇒ Operating the electronic parking brake .
	Brake system fault ⇒   Do not drive on! Brake system fault. .
	Electromechanical steering not functioning ⇒ Troubleshooting .
	Fasten seat belt ⇒ Warning lamp .
	Collision warning from area monitoring system (Front Assist) ⇒ Warning levels and braking intervention .
	Depress the brake pedal.
	Check brake pads ⇒ Troubleshooting .
	Central warning lamp. Observe the additional information on the instrument cluster display.
	Electronic Stability Control (ESC) OR traction control system (TCS) ⇒  TCS regulating to prevent the wheels from spinning. .
	Traction control system (TCS) switched off ⇒  TCS regulating to prevent the wheels from spinning. .
	Fault in anti-lock brake system (ABS) ⇒  ABS failure or fault. .
	Fault in electronic parking brake ⇒ Troubleshooting OR: fault in Hill Start Assist ⇒  Fault in Hill Start Assist .
	Rear fog light switched on ⇒ Switching the fog lights on and off .
	Vehicle lighting is not working ⇒  Vehicle lighting not working .
	Fault in exhaust system ⇒  Fault in exhaust system .
EPC	Fault in engine management system ⇒ Troubleshooting .

Symbol	Meaning
	Engine speed limited ⇒ Troubleshooting .
	Electromechanical steering function reduced ⇒ Troubleshooting .
	Tyre monitoring system ⇒ Troubleshooting for Tyre Pressure Loss Indicator .
	Fault in the rain/light sensor ⇒  Fault in rain/light sensor , ⇒  Fault in rain/light sensor .
	Fault in wipers ⇒ Troubleshooting .
	Washer fluid level too low ⇒ Troubleshooting .
	Fuel tank almost empty ⇒ Fuel gauge .
	Particulate filter clogged up ⇒  Particulate filter clogged with soot .
	Fault in airbag and belt tensioner system ⇒ Indicator lamp .
OFF 	Front passenger front airbag switched off ⇒ Indicator lamp .
ON 	Front passenger front airbag switched on ⇒ Indicator lamp .
	Tank cap open ⇒ Fuel gauge .
	Lane keeping system (Lane Assist) ⇒ Driving with the lane keeping system .
	Adaptive Cruise Control (ACC) not available ⇒  ACC not available. .
	Fault in DSG® dual clutch gearbox: gearbox fault ⇒ Troubleshooting .
	Manual gearbox: clutch temperature high or clutch is defective ⇒ Troubleshooting .
	Area monitoring system (Front Assist) switched off ⇒ Operating the area monitoring system (Front Assist) .
	Adaptive chassis control (DCC) ⇒  Fault in the adaptive chassis control (DCC) .
	Rear Traffic Alert ⇒ Rear Traffic Alert .
	Turn signal ⇒ Switching turn signals on and off .
	Depress the brake pedal.

Symbol	Meaning
	Auto Hold function ⇒ Auto Hold function .
	Adaptive Cruise Control (ACC) ⇒ Switching ACC on and off OR Speed limiter ⇒ Speed limiter .
	Lane keeping system (Lane Assist) ⇒ Driving with the lane keeping system .
	Main beam or headlight flasher ⇒ Switching main beam on and off .
	Coolant ⇒ Coolant temperature display .
	Engine oil pressure ⇒ Troubleshooting .
	Fault in the alternator ⇒ Troubleshooting .
	Adaptive Cruise Control (ACC) ⇒ Switching ACC on and off .
	Speed limiter active ⇒ Speed limiter .
	Adaptive Cruise Control (ACC) ⇒ Switching ACC on and off .
	Distance warning from area monitoring system (Front Assist) ⇒ Warning levels and braking intervention .
	Main-beam control ⇒ Main-beam control .
	Service alert or due service ⇒ Service interval display .
	Charge level of mobile telephone battery ⇒BookletInfotainment system,.
	Outside temperature is below +4°C (+39°F) ⇒ Displays .
	Start/Stop system active ⇒ Start/stop system .
	Start/stop system not available ⇒ Start/stop system .
	Economical mode ⇒ Displays .
	Note about information in the vehicle wallet.













Additional displays: trailer towing

Symbol	Meaning
	Trailer turn signal ⇒  Does not apply in China and Japan: trailer turn signals indicator lamp .

Additional displays: offroad mode

Symbol	Meaning
	Hill Descent Control ⇒ Downhill speed control .
	Offroad driving profile active ⇒ Driving profile selection and 4MOTION Active Control .

Additional displays: diesel vehicles

Symbol	Meaning
	AdBlue® level too low ⇒  AdBlue® level too low .
	Fault in the selective catalytic reduction system ⇒   Fault in the selective catalytic reduction system .
	Water in the fuel ⇒ Fuel gauge .
	Diesel engine ⇒ Troubleshooting .
	AdBlue® level too low ⇒  AdBlue® level low .
	Fault in the selective catalytic reduction system ⇒   Fault in the selective catalytic reduction system .

WARNING

Failure to observe illuminated warning lamps and text messages can lead to your vehicle breaking down in traffic, and can cause accidents and serious injury.

Never ignore any illuminated warning lamps or text messages.

Stop the vehicle as soon as possible and when safe to do so.

Instrument cluster



Introduction

This chapter contains information on the following subjects:

- ⇒ Analogue instrument cluster
- ⇒ Rev counter
- ⇒ Digital instrument cluster (Active Info Display)
- ⇒ Displays
- ⇒ Instrument cluster menus
- ⇒ Service menu
- ⇒ Driving data display (multifunction display)
- ⇒ Warning and information messages
- ⇒ Driver Alert System (recommendation for rest breaks)
- ⇒ Dynamic Road Sign Display (Sign Assist)
- ⇒ Time
- ⇒ Lap timer
- ⇒ Fuel gauge
- ⇒ Coolant temperature display
- ⇒ Service interval display

The vehicle is equipped either with an analogue or a digital instrument cluster (Active Info Display).

When you start the engine after the 12-volt battery has been totally discharged or changed, you may find that system settings (time, date, personal convenience settings and programming) have been changed or deleted. Check and correct the settings as necessary once the 12-volt vehicle battery has been sufficiently charged.



WARNING

Accidents and injuries can occur if the driver is distracted.

Never press the buttons on the instrument cluster while the vehicle is in motion.

Any settings for the instrument cluster display and displays in the Infotainment system should be made only when the vehicle is stationary in order to reduce the risk of accidents and serious injuries.

Analogue instrument cluster

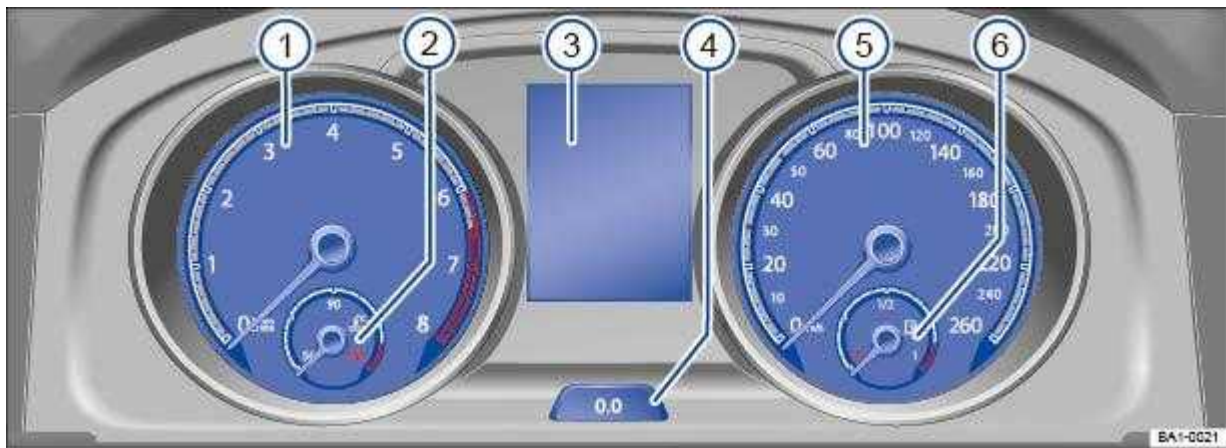

Fig. 11 Analogue instrument cluster in the dash panel.



First read and observe the introductory information and safety warnings ⇒ ⚠ Introduction

Descriptions of the instruments ⇒ Fig. 11 :

①

Rev counter (running engine speed in revolutions x 1,000 per minute) ⇒ Rev counter .

②

Coolant temperature display ⇒ Coolant temperature display .

③

Displays ⇒ Displays .

④

Reset, set and display button.

⑤

Speedometer.

⑥

Fuel gauge ⇒ Fuel gauge .

Rev counter



First read and observe the introductory information and safety warnings ⇒ ⚠ Introduction

Rev counter

The start of the red zone on the rev counter indicates the maximum engine speed that may be used in each gear when the engine is warm and after it has been run in properly. You should change up a gear or move the selector lever to D/S (or lift your foot off the accelerator) before the needle reaches the red zone ⇒ ⚠ .

! NOTICE

When the engine is cold, avoid high engine speeds, driving at full throttle and overloading the engine.

The needle on the rev counter should only briefly point into the red area, as engine damage may otherwise be incurred.



Changing up a gear early will help to save fuel and reduce engine noise.

Digital instrument cluster (Active Info Display)



First read and observe the introductory information and safety warnings ⇒ ⚠ Introduction

The Active Info Display is a digital instrument cluster with high-resolution TFT colour display. To complement the standard dials such as the rev counter and speedometer, users can choose from various "information profiles" to view additional data.

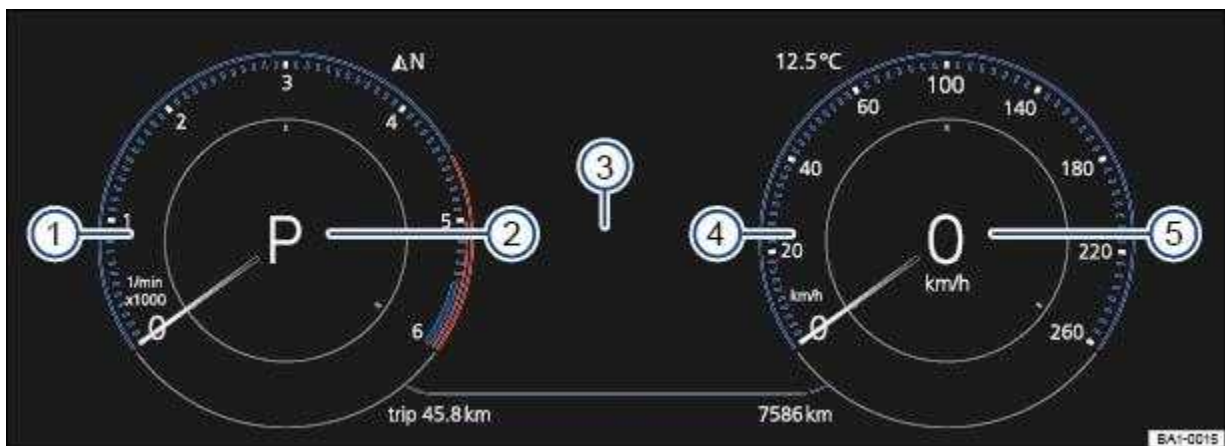

Fig. 12 Active Info Display in the dash panel

Descriptions of the instruments ⇒ Fig. 12 :

①

Rev counter (running engine speed in revolutions x 1,000 per minute) ⇒ Rev counter .

②

Current gear / selector lever position ⇒ Manual gearbox: selecting a gear or ⇒ DSG® dual clutch gearbox .

③

Displays ⇒ Displays .

④

Speedometer.

⑤

Digital speed display.

Information profiles

Various, topic-specific information profiles can be selected via the Active Info Display menu option in the vehicle settings of the Infotainment system ⇒ Vehicle settings menu . Depending on the selected information profile, the Active Info Display shows additional information in the centre of the round instruments, or the round instruments are hidden and the additional information is displayed across the whole width of the display. The following information profiles are available:

Gear. Digital display of the current gear or selected position.

Speed. Digital display of the speed.

Consumption. Graphic representation of current consumption and digital display of average consumption.

Range. Digital display of the remaining range.

Dynamic Road Sign Display. Display of recognised road signs.

Distance travelled. Digital display of the distance covered.

Time of arrival information. Digital display of the remaining driving time, distance to the destination and estimated time of arrival.

Acceleration. Graphic representation of longitudinal and lateral acceleration.

Assist systems. Graphic representation of various assist systems.

Height. Digital display of the current height above sea level.

Navigation. Graphic representation of arrow navigation.

Compass. Digital compass display.

Audio. Digital display of current audio playback.



The number and functions of the available information profiles can differ depending on the vehicle equipment.

Navigation map in the Active Info Display

With some vehicle equipment levels, the Active Info Display is able to display a detailed map. To display this map, select the Navigation menu item in the instrument cluster ⇒ Instrument cluster menus .

The navigation map can be shown in two sizes. With the larger map size, the navigation map is displayed over the entire width of the display. To select the preferred map size:

Press the **OK** button on the multifunction steering wheel ⇒ Instrument cluster menus to switch between map sizes as required.

OR: press the  or  arrow button on the multifunction steering wheel to select the required map size. A frame appears around the selected option.

Press the **OK** button on the multifunction steering wheel to confirm your selection.

With some equipment levels, navigation is shown on two screens or only one. The navigation map can be displayed on the Active Info Display and Infotainment system or only on the Infotainment system display. In the latter case, only navigation arrows are shown on the Active Info Display.

Displays



First read and observe the introductory information and safety warnings ⇒  Introduction

Possible instrument cluster displays

Open doors, bonnet and boot lid.

Warning and information messages.

Mileage displays.

Time ⇒ Time .

Radio and navigation information ⇒ Booklet Infotainment system, .

Telephone information ⇒ Booklet Infotainment system, .

Outside temperature.

Compass display.

Selector lever positions.

Gear-change indicator ⇒ Gear-change indicator .

Driving data display (multifunction display) and menus for various settings ⇒ Instrument cluster menus .

Service interval display ⇒ Service interval display .

Speed warning ⇒ Instrument cluster menus .

Speed warning for winter tyres.

Start/stop system status display ⇒ Start/stop system .

Road signs detected by the Dynamic Road Sign Display system ⇒ Dynamic Road Sign Display (Sign Assist) .

Status display for Active Cylinder Management (ACT®) ⇒ Driving economically .

Economical mode  .

Engine code.

Display of driver assist systems ⇒ Driver assist systems .

Personalisation: welcome and user selection ⇒ Personalisation .

Open doors, bonnet and boot lid

The instrument cluster display indicates if any doors, the engine compartment or boot lid are open once the vehicle has been unlocked, and while the vehicle is in motion. In some cases, a signal tone is also given. Different instrument cluster designs may have different displays.

Selector lever positions (DSG® dual clutch gearbox)

The gear selected is displayed on the side of the selector lever and on the display in the instrument cluster. The instrument cluster display may show which gear has been selected if the selector lever is in D/S position or in Tiptronic mode ⇒ DSG® dual clutch gearbox .

Outside temperature display

If the outside temperature falls below approximately +4°C (+39°F), the temperature display also shows a snowflake symbol ❄️. This symbol remains lit up until the outside temperature rises above +6°C (+43°F) ⇒ ⚠️ .

Heat radiated from the engine may cause the temperature display to show a slightly higher value than the actual outside temperature if the vehicle is stationary, the auxiliary heater ⇒ Auxiliary heater and ventilation is switched on or the vehicle is travelling at a very low vehicle speed.

The measured range is -45°C (-49°F) to +76°C (+169°F).

Gear-change indicator

While the vehicle is in motion, the instrument cluster may show which gear should be selected to reduce fuel consumption ⇒ Gear-change indicator .

Mileage displays

The odometer registers the total distance travelled by the vehicle.

The trip recorder (trip) shows the distance travelled since the trip recorder was last reset.

Vehicles with analogue instrument cluster: press the **0.0** button in the instrument cluster briefly to reset the trip recorder to 0 ⇒ Analogue instrument cluster .

Vehicles with digital instrument cluster: reset the trip recorder via the Infotainment system or via the multifunction display ⇒ Infotainment system controls and displays or ⇒ Driving data display (multifunction display) .

Speed warning for winter tyres

A display in the instrument cluster indicates when the set maximum speed has been exceeded ⇒ Instrument cluster menus .

Speed warning settings can be made in the vehicle settings in the Infotainment system ⇒ Vehicle settings menu .

Compass display

When the ignition is switched on, depending on the equipment level, the instrument cluster display shows the current direction of travel in the form of an abbreviation, e.g. NW for north west.

The graphic compass display is also available when the Infotainment system is switched on and route guidance is not active.

Economical mode 

While you drive, the instrument cluster display shows whether the vehicle is in an economical mode .

Engine code

Vehicles with analogue instrument cluster.

Switch on ignition, but the engine must not run.

Press and hold the **0.0** button on the instrument cluster for around 15 seconds to display the engine code.

Vehicles with digital instrument cluster.

Select the Range information profile on the instrument cluster.

Press and hold the **OK** button on the multifunction steering wheel until the Service menu is available on the instrument cluster display ⇒ Service menu .

Select the Engine code menu option.

WARNING

Streets and bridges can be iced over at outside temperatures above freezing point.

The snowflake symbol indicates that there is a risk of black ice.

There may be black ice on the roads even when outside temperatures are above +4°C (+39°F), even when no snowflake symbol is displayed.

You should never rely solely on the outside temperature display!



Different instrument clusters are available, which means that the versions and displays may vary. In displays without warning or information texts, faults are indicated exclusively by indicator lamps.



Some displays in the instrument cluster may be overridden by sudden alerts, e.g. incoming telephone calls.



With some equipment levels, some settings and displays may also appear in the Infotainment system.



If several warnings are present, the symbols will appear for several seconds, one after another. The symbols will continue to appear until the faults are rectified.



If warning messages about malfunctions are displayed when the ignition is switched on, it may not be possible to adjust some settings as described, or the information display may appear differently. If this is the case, take the vehicle to a qualified workshop to have the malfunctions rectified.

Instrument cluster menus



First read and observe the introductory information and safety warnings ⇒ Introduction

The content and layout of the menus and displays depend on the vehicle electronics and the level of vehicle equipment.

A qualified workshop can program and modify other functions depending on the vehicle equipment level. Volkswagen recommends using a Volkswagen dealership for this purpose.

Some menu options can be accessed only when the vehicle is stationary.

Driving data ⇒ Driving data display (multifunction display)

Assist systems.

Lane Assist on/off ⇒ Lane keeping system (Lane Assist)

Front Assist on/off ⇒ Area monitoring system (Front Assist) .

Blind Spot Monitor on/off ⇒ Blind Spot Monitor .

ACC (display only) ⇒ Adaptive Cruise Control (ACC) .

Views¹⁾ ⇒ Digital instrument cluster (Active Info Display) .

Navigation ⇒ Booklet Infotainment system, .

Audio ⇒ Booklet Infotainment system, .

Telephone ⇒ Booklet Infotainment system, .

Vehicle status ⇒ Warning and information messages .

Lap timer ⇒ Lap timer .

Personalisation (user selection) ⇒ Personalisation .

1) Only in vehicles with an Active Info Display.

Service menu



First read and observe the introductory information and safety warnings ⇒  Introduction

Settings can be made in the Service menu¹⁾ depending on the vehicle equipment.

Opening the Service menu

To open the Service menu, select the Range information profile and press and hold the OK button on the multifunction steering wheel for around four seconds. You can now navigate in the menu in the usual way using the buttons on the multifunction steering wheel.

Resetting the service interval display

Select the Service menu and follow the instructions on the instrument cluster display.

Resetting oil change service

Select the Reset oil service menu and follow the instructions on the instrument cluster display.

Resetting driving data

Select the Reset trip menu and follow the instructions on the instrument cluster display to reset the desired value.

Engine code

Select the Engine code menu. The engine codes are now shown on the instrument cluster display.

Setting the time

Select the Time menu and set the correct time with the arrow buttons  or .

1) Only in vehicles with an Active Info Display.

Driving data display (multifunction display)



First read and observe the introductory information and safety warnings ⇒  Introduction



The driving data display (multifunction display) shows a variety of travel and fuel consumption data.

Switching between displays

Vehicles without multifunction steering wheel:

Press the rocker switch **TRIP** on the wiper lever ⇒ Operating using the wiper lever .

Vehicles with multifunction steering wheel:

Press the  or  button ⇒ Operating using the multifunction steering wheel .

Switching between memories

Press the **OK/RESET** button on the wiper lever, or press the **OK** button on the multifunction steering wheel.

Since start memory

The memory will be deleted if the journey is interrupted for more than two hours.

Since refuelling memory

Display and storage of the collected driving and consumption values. The memory is deleted when the tank is refilled.

Long-term memory

The memory collects driving data for up to 19 hours and 59 minutes or 99 hours and 59 minutes of driving time or 1,999.9 km or 9,999.9 km distance covered. The memory is deleted if one of these maximum values¹⁾ is exceeded.

Deleting driving data memories

Select the memory that you wish to delete.

Press and hold the **OK/RESET** button on the wiper lever or the **OK** button on the multifunction steering wheel for approximately two seconds.

Selecting displays

You can select which driving data you want to display in the vehicle settings in the Infotainment system ⇒ Vehicle settings menu .

Average consumption display

The average fuel consumption is displayed after approx. 300 metres.

Range display

Approximate driving distance in km that the vehicle can still travel if the same driving style is maintained.

SCR range or Range  2) display

Approximate driving distance in km that can still be travelled with the remaining quantity of AdBlue[®] if the current driving style is maintained. This display appears only when the remaining range reaches 2,400 km and cannot be cancelled.

Average speed display

The average speed is displayed after approximately 100 metres.



Convenience consumers

List of active convenience systems which can increase energy consumption, e.g. the air conditioning.

Setting the speed warning

Select the display Warning at --- km/h or Warning at --- mph.

Press the **OK/RESET** button on the windscreen wiper lever or the **OK** button on the multifunction steering wheel to save the current speed and activate the warning.

Within around five seconds, set the speed with the **TRIP** rocker switch on the wiper lever or the  or  buttons on the multifunction steering wheel. Then press the **OK/RESET** or **OK** button or wait a few seconds. The speed is now saved and the warning is activated.

To deactivate, press the **OK/RESET** or **OK** button again. The stored speed will be deleted.

The speed warning can be adjusted within a range of 30 km/h (18 mph) to 250 km/h (155 mph).



Some settings can be saved in the user accounts for personalisation and therefore change automatically when the user account is changed ⇒ Personalisation .

1) Varies depending on the instrument cluster version.

2) Not available in all countries.

Warning and information messages



First read and observe the introductory information and safety warnings ⇒  Introduction

The system runs a check on certain components and functions in the vehicle when the ignition is switched on or while the vehicle is in motion. Malfunctions are indicated by red and yellow warning symbols with information messages on the instrument cluster display ⇒ Symbols in instrument cluster . An acoustic warning is also given in certain cases. The appearance of the information messages and symbols can vary depending on the version of the instrument cluster.

In addition, a list of current malfunctions can be opened manually. To open the list, select the Vehicle status or Vehicle menu ⇒ Instrument cluster menus .

Priority 1 warning (red) The symbol flashes or lights up (sometimes together with a signal tone). 

Do not drive on! Danger. Check the fault and correct the cause. Seek expert assistance if necessary. Priority 2 warning (yellow) The symbol flashes or lights up (sometimes together with a signal tone). Malfunctions and insufficient service fluids can damage the vehicle and cause it to break down. Check the fault as soon as possible. Seek expert assistance if necessary. Information message Information about various vehicle procedures and conditions.



With some equipment levels, some settings and displays may also appear in the Infotainment system.



If several warnings are present, the symbols will appear for several seconds, one after another. The symbols will continue to appear until the faults are rectified.



If warning messages about malfunctions are displayed when the ignition is switched on, it may not be possible to adjust some settings as described, or the information display may appear differently. If this is the case, take the vehicle to a qualified workshop to have the malfunctions rectified.

Driver Alert System (recommendation for rest breaks)



First read and observe the introductory information and safety warnings ⇒ Introduction

The Driver Alert System informs the driver if their driving shows signs of tiredness.



Fig. 13 On the instrument cluster display: Driver Alert System symbol.

Function and operation

The Driver Alert System determines the driving behaviour of the driver at the start of a journey and uses this to calculate a fatigue assessment. This is continuously compared with the current behaviour of the driver while driving. If the system detects that the driver may be tired, an acoustic warning signal will sound and a symbol ⇒ Fig. 13 will be displayed on the instrument cluster display as a visual indication in combination with a supplementary text message. The message in the instrument cluster display is displayed for about five seconds and may be repeated once. The last displayed message is saved by the system.

The message on the instrument cluster display can be switched off by pressing the **OK/RESET** button on the wiper lever or the **OK** button on the multifunction steering wheel ⇒ Operating the instrument cluster . The message can be displayed again on the instrument cluster display using the multifunction display ⇒ Warning and information messages .

Function conditions

The driving behaviour can be evaluated only when the speed is above 60 km/h (37 mph) up to approximately 200 km/h (125 mph).

Switching on and off

The Driver Alert System can be activated and deactivated in the vehicle settings in the Infotainment system ⇒ Vehicle settings menu .

Function limitations

The Driver Alert System has system-related limitations. The following conditions can limit the function of the Driver Alert System, or prevent it from working altogether:

Speeds below 60 km/h (37 mph).

Speeds above 200 km/h (125 mph).

Twisting roads.

Poor roads.

Adverse weather conditions.

Sporty driving style.

Towing a heavy/long trailer.

The driver is distracted.

The Driver Alert System is reset in the following situations:

The ignition is switched off.

The driver seat belt is unfastened and the driver door is opened.

The vehicle has been stationary for longer than 15 minutes.

The Driver Alert System is automatically reset in the event of an extended period of driving at slow speeds (speed less than 60 km/h (37 mph)). When the speed is increased again, the system evaluates the driving behaviour once more.

 **WARNING**

The intelligent technology used in the Driver Alert System cannot overcome the laws of physics, and functions only within the limits of the system. Do not let the extra convenience afforded by the Driver Alert System tempt you into taking any risks when driving. During a long trip, plan regular and sufficient breaks.

The driver is responsible at all times for their fitness to drive.

Never drive a vehicle when you are tired.

The system cannot always detect the driver's level of alertness. Observe the information in the Function limitations section.

In certain situations, the system may wrongly interpret intentional driving manoeuvres as a lack of alertness from the driver.

No urgent warning will be given in the event of the phenomenon known as microsleep.

Observe the information in the instrument cluster display and act according to the commands.



The Driver Alert System has been developed for use only while driving on motorways and good roads.



If there is a system fault, go to a qualified workshop and have the system checked.

Dynamic Road Sign Display (Sign Assist)

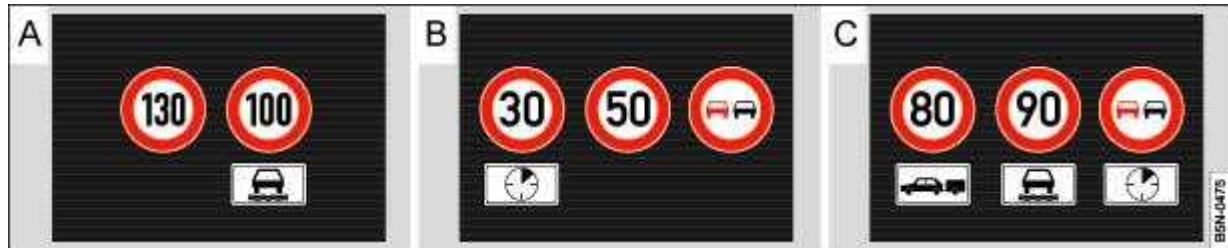

Fig. 14 On the instrument cluster display: examples of recognised speed limits and overtaking restrictions with accompanying additional signs.



First read and observe the introductory information and safety warnings ⇒ Introduction

Dynamic Road Sign Display uses a camera in the base of the interior mirror to monitor standard road signs and informs the driver of any detected speed limits or overtaking restrictions. Within the limits of the system, the system also displays additional signs, e.g. temporary restrictions, signs related to towing a trailer ⇒ Trailer towing or restrictions in wet weather conditions. In some cases, the system can also display the current speed limits on non-signposted routes.

Displays

In addition to speed limits and overtaking restrictions, Dynamic Road Sign Display also detects the sign which indicates that all restrictions have been lifted on motorways and main roads in Germany. In all other countries, the currently valid speed limit is displayed instead.

The road signs detected by Dynamic Road Sign Display are displayed on the instrument cluster ⇒ Fig. 14 and in some cases also on the Infotainment system, depending on which version is installed in the vehicle. In some equipment levels, a display is also shown on the Head-up Display ⇒ Instrument cluster .

No road signs available The system is in the initialisation phase. OR: the camera has not detected any mandatory or warning signs. Error: Dynamic Road Sign Display System fault. Go to a qualified workshop. Speed warning currently unavailable. Fault in the Dynamic Road Sign Display system speed warning. Go to a qualified workshop. Dynamic Road Sign Display: clean the windscreen! The area around the camera on the windscreen is dirty. Clean the windscreen ⇒ Vehicle care . Dynamic Road Sign Display currently restricted. No data transmission from the Infotainment system. Check whether valid map data is loaded in the Infotainment system. OR: the vehicle is located in an area that is not covered by the map stored in the Infotainment system. No data available Dynamic Road Sign Display is not supported in the country in which you are currently travelling.

Switching on and off

Continuous display of road signs in the instrument cluster can be activated and deactivated in the vehicle settings in the Infotainment system.

Display of road signs

After validation and evaluation of the information from the camera, the Infotainment system and the current vehicle data, the activated Dynamic Road Sign Display shows up to three valid road signs ⇒ Fig. 14 **B** with the accompanying additional signs:

1st position: The road sign that currently applies for the driver is shown on the left-hand side of the display, e.g. a speed limit of 130 km/h (80 mph) ⇒ Fig. 14 **A**.
2nd position: Road signs that do not always apply (e.g. 100 km/h (60 mph) in wet) are shown in second place. Additional sign: if the windscreen wiper is active while the vehicle is in motion, the now valid road sign with the additional In wet sign, for example, will be moved left to the first position.
3rd position: Further road signs that do not always apply will be displayed in the third position, e.g. overtaking not permitted at certain times ⇒ Fig. 14 **C**.

Speed warning

If the Dynamic Road Sign Display detects that an applicable speed limit has been exceeded, it can issue an acoustic warning signal and display a message on the instrument cluster display.

The speed warning can be set or completely deactivated in the vehicle settings in the Infotainment system ⇒ Vehicle settings menu . The settings can be adjusted in increments of 5 km/h (3 mph) within a range between 0 km/h (mph) and 15 km/h (9 mph) above the permitted maximum speed.

Trailer mode

In vehicles with a factory-fitted towing bracket and a trailer with an electrical connection to the vehicle, the display of road signs that may apply to the vehicle when towing a trailer, e.g. applicable speed limits and no-overtaking signs, can be activated or deactivated in the vehicle settings in the Infotainment system ⇒ Vehicle settings menu .

In trailer mode, the speed warning function display can be adjusted to the type of trailer or to legal requirements. The settings can be adjusted in increments of 10 km/h (5 mph) within a range between 60 km/h (40 mph) and 130 km/h (80 mph). If a higher speed is set than is permitted for driving with a trailer in the country in which you are currently travelling, Dynamic Road Sign Display automatically issues a warning at the usual speed limit, e.g. at 80 km/h (50 mph) in Germany.

If the speed warning for the trailer is deactivated, Dynamic Road Sign Display issues warnings as if the vehicle was being driven without a trailer.

Function limitations

Dynamic Road Sign Display is subject to system-related limitations. The following conditions can restrict the function of Dynamic Road Sign Display, or prevent it from working altogether:

Poor visibility, e.g. snow, rain, fog or heavy spray.

Glare, e.g. due to oncoming traffic or sunlight.

High speeds.

Covered or dirty camera.

Road signs that are located outside of the camera's field of view.

Partially or fully hidden traffic signs, e.g. by trees, snow, dirt or other vehicles.

Road signs that do not correspond to the standard design.

Damaged or bent traffic signs.

Variable road signs on gantries (changeable road sign display using LEDs or other light sources).

Out-of-date map material in the Infotainment system.

Stickers on vehicles that show road signs, e.g. speed restrictions on trucks.

 WARNING

The intelligent technology used by the Dynamic Road Sign Display cannot overcome the laws of physics, and functions only within the limits of the system. Do not let the extra convenience afforded by the Dynamic Road Sign Display system tempt you into taking any risks when driving. The system is not a substitute for the full concentration of the driver.

Always adapt your speed and driving style to suit visibility, weather, road and traffic conditions.

Poor visibility, darkness, snow, rain and fog can cause road signs not to be displayed or to be incorrectly displayed by the system.

If the camera's field of view is dirty, covered or damaged, the function of the Dynamic Road Sign Display system may be impaired.

 WARNING

Driving recommendations and traffic symbols displayed by the Dynamic Road Sign Display system may differ from the current traffic situation.

Not all road signs can be recognised by the system and displayed correctly.

Road signs on the road and traffic regulations have priority over the recommendations and displays provided by the Dynamic Road Sign Display system.

 NOTICE

Availability of the Dynamic Road Sign Display function is limited in waypoint mode (waypoint navigation) of the Infotainment system.



Some settings can be saved in the user accounts of the personalisation function and can therefore change automatically when the user account is changed ⇒ Personalisation .

Time



First read and observe the introductory information and safety warnings ⇒ Introduction

Press the **MENU** button or function button.

Press the Vehicle and function buttons.

Select the Time and date menu option to set the time ⇒ Vehicle settings menu .

To set the time (on all vehicle clocks), press and hold the **0.0** button in the instrument cluster until the word Time appears in the display ⇒ Analogue instrument cluster .

Release the **0.0** button. The time is shown in the instrument cluster display and the hour setting is marked.

Then press the **0.0** button repeatedly until the required hour value is displayed. Press and hold the **0.0** button to scroll through quickly.

Once you have set the hour, wait until the minutes display is marked in the instrument cluster display.

Then press the **0.0** button repeatedly until the required minute value is displayed. Press and hold the **0.0** button to scroll through quickly.

Release the **0.0** button to finish setting the clock.

Select the Range information profile.

Press and hold the **OK** button on the multifunction steering wheel until the Service menu is available on the instrument cluster display ⇒ Service menu .

Select the Time menu.

Set the correct time with the arrow buttons or .

Lap timer



First read and observe the introductory information and safety warnings ⇒ Introduction

With the appropriate equipment the lap timer can be shown on the instrument cluster display ⇒ Instrument cluster menus .

The lap timer has the option of timing your own laps manually in the vehicle on a race track, to store the times and to compare them with best times.

The following higher-level menus can be displayed:

Lap timer

Lap (with the current lap number)

Statistics

Switching between the menus

Vehicles without multifunction steering wheel:

Press the rocker switch **TRIP** on the wiper lever ⇒ Operating the instrument cluster .

Vehicles with multifunction steering wheel:

Press the  or  button ⇒ Operating the instrument cluster .

The following list shows an example of how the menus in the instrument cluster display are structured. The actual scope of the menus and the names of the individual menu options vary according to the instrument cluster design and the vehicle electronics.

Menu displays and functions

Lap timer menu

Start Starts the lap timer. Since start timing starts when the vehicle drives off. If the vehicle is already in motion, timing will begin when the vehicle has come to a temporary standstill. **Statistics** An overview of the laps driven until now are displayed.

Lap menu

Stop! Active timing is interrupted. This will not end the lap. **Continue** Paused timing resumes. **Split time:** A split time will be displayed for approximately five seconds. Active timing continues parallel to this. **New lap** Timing of the current lap will then be interrupted and a new lap will begin. The time of the completed lap will be carried over to the statistics. **Abort lap** The timing is ended and disregarded. The current lap is not entered into the statistics. **End** Timing is ended. The lap is entered into the statistics.

Statistics menu

Back It will be reset to the previous menu. **Reset** All stored statistics data will be reset.

In the Statistics menu, the lap times most recently achieved are shown. If the maximum number of 99 laps or the maximum time of 99 hours, 59 minutes and 59 seconds has been reached, a new timing can only be started after the statistics have been reset.



Accidents and injuries can occur if the driver is distracted.

Make lap timer settings and access statistics only when the vehicle is stationary.

When the vehicle is in motion, use the lap timer only in driving situations which are easy to control.

Fuel gauge

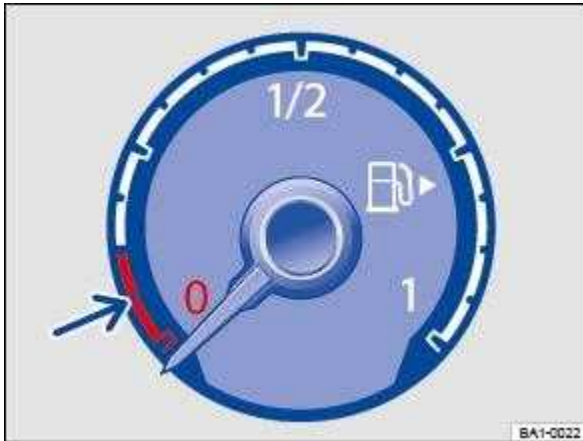

Fig. 15 Fuel gauge in the analogue instrument cluster.

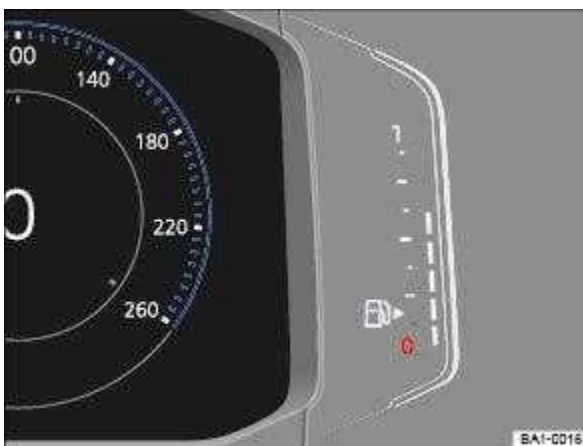

Fig. 16 Fuel gauge in the Active Info Display.



First read and observe the introductory information and safety warnings ⇒ ⚠ Introduction



Fuel tank almost empty.

The indicator lamp lights up yellow. The reserve volume, red marking, is being consumed ⇒ ⚠ .

Fill the tank as soon as possible.



Water in the diesel fuel.

The indicator lamp lights up yellow.

Switch off the engine and seek expert assistance.



Tank cap open.

The indicator lamp lights up yellow.

Close the tank cap.

 **WARNING**

Driving when the fuel level is too low can lead to the vehicle coming to a standstill in traffic, potentially causing accidents and serious injuries.

When the fuel level is too low, the fuel supply to the engine could be irregular, especially when driving up or down hills and inclines.

The steering, all driver assist systems and brake support systems stop working if the engine sputters or goes off due to fuel shortage or irregular fuel supply.

Always fill the tank when it is still 1/4 full. This reduces the risk of running out of fuel and breaking down.

 **NOTICE**

Do not run the tank empty. The irregular fuel supply can cause misfiring and allow unburnt fuel to enter the exhaust system. The catalytic converter or particulate filter could be damaged as a result.



The small arrow next to the petrol pump symbol in the fuel gauge shows you the side of the vehicle on which the tank flap is located.

Coolant temperature display



Fig. 17 Coolant temperature display in the analogue instrument cluster.

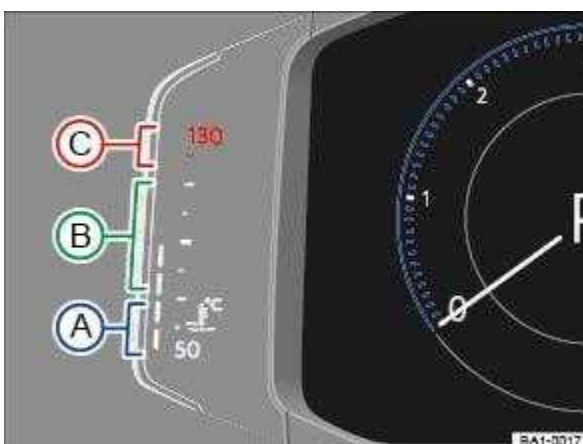

Fig. 18 Coolant temperature gauge in the Active Info Display.



First read and observe the introductory information and safety warnings⇒ ⚠️ Introduction

A Cold area. The engine has not yet reached operating temperature. Avoid high engine revs and heavy engine loads until the engine is warm.

B Normal area.

C Warning area. The temperature may also rise to the hot area when the engine is working hard, especially at high ambient temperatures.

Coolant

The indicator lamp lights up and the central warning lamp flashes red.

The coolant level is not correct or there is a fault in the coolant system.

Do not drive on!

Stop the vehicle, switch off the engine and allow it to cool down.

Check the coolant level ⇒ Coolant .

Seek expert assistance if the warning lamp does not go out although the coolant level is adequate.

Service interval display



Fig. 19 In the instrument cluster display: display example for a due service event (illustration).



First read and observe the introductory information and safety warnings⇒ ⚠️ Introduction

The service event displays are shown on the instrument cluster ⇒ Fig. 19 and in the Infotainment system.

Versions and displays can vary as different versions of the instrument cluster and Infotainment system are available.

In vehicles with fixed oil change service, services take place at predefined service intervals.

In vehicles with flexible oil change service, the service intervals are calculated on an individual basis. Technical progress has made it possible to considerably reduce servicing requirements. An oil change service must only be carried out when required by the vehicle. The individual conditions in which the vehicle is used and the driver's personal driving style are taken into account. The service reminder is displayed 30 days before the service is due. The distance is rounded to the nearest 100 km and the remaining time is rounded to full days.

Service alert

If a service or inspection is due soon, a service alert will appear the next time the ignition is switched on.

The number of kilometres or amount of time shown correspond to the maximum number of kilometres or maximum time that can still be driven before the next service.

Service event

In the event of a due service or a due inspection, a signal tone will be given when the ignition is switched on and the spanner symbol  will be displayed for several seconds on the instrument cluster display. One of the following displays will also appear ⇒ Fig. 19 :

Inspection now!

Oil service now!

Oil service and inspection now!

Checking service schedules

You can access the current scheduled service information when the ignition is switched on, the engine is not running, and the vehicle is stationary:

Accessing the service schedule in the Infotainment system.

Press the **MENU** button or function button.

Press the Vehicle and  function buttons ⇒ Infotainment system controls and displays .

Select the Service menu option to display the service information.

Vehicles with analogue instrument cluster.

Press and hold the **0.0** button in the instrument cluster ⇒ Instrument cluster until the text Service appears in the display.

Release the **0.0** button. The current scheduled service will be shown in the display.

Vehicles with digital instrument cluster.

Information on the scheduled service can be accessed only via the Service menu ⇒ Service menu .

Resetting the service interval display

If the service or the inspection was not performed by a Volkswagen dealership, the display can be reset as follows:

Vehicles with analogue instrument cluster.

Switch off the ignition.

Press and hold the **0.0** button in the instrument cluster ⇒ Instrument cluster .

Switch on the ignition again.

Release the **0.0** button when one of the following messages appears on the instrument cluster display: Reset oil service? or Reset inspection?.

Press the **0.0** button on the instrument cluster ⇒ Instrument cluster to confirm.

Vehicles with digital instrument cluster.

The service interval display can be reset only via the Service menu ⇒ Service menu .

Do not reset the service interval display between service intervals otherwise incorrect data will be shown.

If the oil change service was manually reset, the service interval display then also changes to a fixed service interval in vehicles with flexible oil change service.



The service message will disappear after a few seconds when the engine is running, or when the **OK** /**RESET** button on the wiper lever or the **OK** button on the multifunction steering wheel is pressed ⇒ Operating the instrument cluster .



If the 12-volt vehicle battery was disconnected for long periods in vehicles with flexible service, the system cannot calculate the time at which the next service is due. The information shown in the service interval display may therefore be incorrect. In this case, please observe the maximum permissible service intervals ⇒ Service .

Operating the instrument cluster



Introduction

This chapter contains information on the following subjects:

⇒ Operating using the wiper lever

⇒ Operating using the multifunction steering wheel

⇒ Button for driver assist systems

Some menu options can be accessed only when the vehicle is stationary.

The buttons on the wiper lever are omitted in vehicles equipped with a multifunction steering wheel
⇒ Operating using the wiper lever .

WARNING

Accidents and injuries can occur if the driver is distracted.

Never operate the menus on the instrument cluster display while the vehicle is in motion.



Check the system settings after charging or replacing the 12-volt vehicle battery. System settings may be changed or deleted if the power supply is interrupted.

Operating using the wiper lever



Fig. 20 On the right of the steering column: buttons on the wiper lever (illustration).



First read and observe the introductory information and safety warnings ⇒  Introduction

If any priority 1 ⇒ Instrument cluster warning messages are displayed, you will be unable to open any menus. Some warnings can be confirmed and hidden using the button ⇒ Fig. 20 ①.

Selecting a menu or information display

Switch on the ignition.

Personalisation: select user.

If a message or vehicle pictogram is displayed, press the ⇒ Fig. 20 ① button, several times if necessary.

To display the menus ⇒ Instrument cluster menus or to return from a menu or an information display to the menu selection, hold down the rocker switch ⇒ Fig. 20 ②.

To browse through the menus, press the rocker switch up or down.

To open the menu or information display, press button ⇒ Fig. 20 ① or wait until the menu or information display opens automatically after a few seconds.

Changing settings in menu

In the menu displayed, press the rocker switch ⇒ Fig. 20 ② on the wiper lever upwards or downwards until the desired menu option is marked. A frame appears around the selected option.

Press the ⇒ Fig. 20 ① button to make the required changes. A tick indicates that the particular system or function is active.

Returning to menu selection

In the menu, select the Back menu option to exit the menu.



If warning messages about malfunctions are displayed when the ignition is switched on, it may not be possible to adjust some settings as described, or the information display may appear differently. If this is the case, take the vehicle to a qualified workshop to have the malfunction rectified.

Operating using the multifunction steering wheel



Fig. 21 Right-hand side of the multifunction steering wheel: controls for using the menus and information displays in the instrument cluster.



First read and observe the introductory information and safety warnings ⇒ Introduction

If any priority 1 ⇒ Warning and information messages warning messages are displayed, you will be unable to open any menus. Some warnings can be confirmed and hidden with the **OK** button on the multifunction steering wheel ⇒ Fig. 21 .

Selecting a menu or information display

Switch on the ignition.

Personalisation: select user.

If a message or the vehicle pictogram is displayed, press the **OK** button ⇒ Fig. 21 , several times if required.

Press the  or  button to display a menu or browse through a menu ⇒ Fig. 21 .

To open the menu or information display, press **OK** ⇒ Fig. 21 or wait until the menu or information display opens automatically after a few seconds.

Changing settings in menus

In the displayed menu, press the arrow keys Δ or ∇ \Rightarrow Fig. 21 until the desired menu option is marked. A frame appears around the selected option.

Press the **OK** button \Rightarrow Fig. 21 to make the required changes. A tick indicates that the particular system or function is active.

Returning to menu selection

Press the  or  button \Rightarrow Fig. 21 .



If warning messages about malfunctions are displayed when the ignition is switched on, it may not be possible to adjust some settings as described, or the information display may appear differently. If this is the case, take the vehicle to a qualified workshop to have the malfunction rectified.

Button for driver assist systems

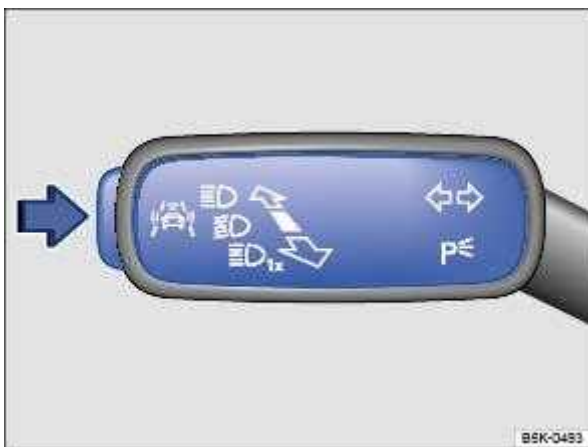

Fig. 22 On the turn signal and main beam lever on the left of the steering column: button for driver assist systems.



First read and observe the introductory information and safety warnings \Rightarrow  Introduction

You can switch the driver assist systems listed in the Assist systems menu on and off with the button on the turn signal and main beam lever.

Switching individual driver assist systems on and off

Press the button \Rightarrow Fig. 22 in the direction of the arrow to open the Assist systems menu.

Select the driver assist system and switch it on or off \Rightarrow Operating the instrument cluster . A tick indicates that a driver assist system is switched on.

Mark and confirm your selection by pressing the **OK/RESET** button on the wiper lever, or by pressing the **OK** button on the multifunction steering wheel.

The driver assist systems can also be switched on and off in the vehicle settings in the Infotainment system \Rightarrow Vehicle settings menu .

Infotainment system controls and displays



Introduction

This chapter contains information on the following subjects:

⇒ Vehicle settings menu

⇒ Performance monitor

⇒ Lap timer

⇒ Personalisation

The Infotainment system combines key vehicle systems in a central operating unit, e.g. menu settings, radio or navigation system.

General information on operation

The following section contains relevant information on the settings that can be adjusted in the Vehicle settings menu. Basic information on operating the Infotainment system and on warning and safety instructions is contained in a separate manual ⇒ Booklet Infotainment system,.

Systems settings and vehicle information display

After pressing the button or touching the function button **MENU** followed by the Vehicle function button, touch the corresponding function buttons to display information or make settings. The current status of systems can be checked or system faults displayed by touching the  function button in the Vehicle status menu.

Vehicle settings (setup) ⇒ Vehicle settings menu .

Think Blue. Trainer. ⇒ Think Blue. Trainer.

Performance monitor ⇒ Performance monitor .

Lap timer ⇒ Lap timer .

Offroad display ⇒ Offroad driving situations .

Auxiliary heater settings ⇒ Auxiliary heater and ventilation .

Active media.

Driving data.

Vehicle status.

Convenience consumers.

Radio station selection.



WARNING

Accidents and injuries can occur if the driver is distracted. Operating the Infotainment system can distract you from the road.

Always drive carefully and responsibly.



When you start the engine after the 12-volt vehicle battery has been totally discharged or changed, you may find that system settings (time, date, personal convenience settings and programming) and user accounts have been changed or deleted. Check and correct the settings as necessary once the 12-volt vehicle battery has been sufficiently charged.

Vehicle settings menu



First read and observe the introductory information and safety warnings ⇒ Introduction

You can switch individual functions and systems on and off and make settings in the vehicle settings of the Infotainment system.

Opening the Vehicle settings menu

Switch on the ignition.

Switch on Infotainment system if necessary.

Press the **MENU** button or function button.

Touch the Vehicle and function buttons to open the Vehicle settings menu.

Touch the corresponding function buttons to open additional menus in the Vehicle settings menu or to make settings in the menu options.

If the checkbox in the function button is ticked , the respective function is switched on.

Touch the function button to return to the previous menu.

Performance monitor



First read and observe the introductory information and safety warnings ⇒ Introduction

The performance monitor is a display for sporty driving. The digital instruments display real-time values for engine power, temperature and acceleration that are determined by sensors on the vehicle. This provides the driver with an overview of driving dynamics.



Fig. 23 On the Infotainment system display: performance monitor.

Key to ⇒ Fig. 23 :

① Display areas.

② Arrow buttons for changing to the lap timer.

Opening the performance monitor

Press the MENU button or function button on the Infotainment system.

Touch the Vehicle function button.

Touch the Selection function button.

Touch the Sport function button.

If you would like to switch between the performance monitor and the lap timer ⇒ Lap timer , touch one of the arrow buttons on the left and right above the instruments ⇒ Fig. 23 ②.

Selecting instruments and setting units

The display can show a maximum of three instruments at the same time. Each instrument can be selected for each display area ⇒ Fig. 23 ① (left, middle, right).

To change between instruments, swipe vertically over the display. The currently selected instrument will then disappear and a new instrument will appear.

The units can be adjusted for some instruments in the Infotainment system ⇒ Vehicle settings menu .

The following instruments can be displayed:

Charge pressure display: the charge pressure display ⇒ Fig. 23 ① (left) shows the pressure in the charge air system between the turbocharger and engine (in the unit bar). The further to the right the needle on the scale, the higher the engine power output.

Accelerometer (G-meter): the accelerometer (G-meter) ⇒ Fig. 23 ① (centre) shows the acceleration value in the centre (in the unit g). The red marking in the grid-type area shows the acceleration level and the direction of the acting force (in the opposite direction according to physical laws). If you drive to the left, for example, the red marking will move in the right area of the instrument (and vice versa). If you accelerate, the red marking will move down. If you brake, the red marking will move up. The level of acceleration is indicated by the position of the red marking which moves outwards. If the acceleration increases, the red marking will move away from the centre area.

Power display: the power display ⇒ Fig. 23 ① (right) shows the current engine power output as a digital value and on the surrounding scale (in kW).

Coolant temperature display: the needle may move further in a clockwise direction under high engine loads and with high outside temperatures. This is no cause for concern unless the  indicator lamp in the instrument cluster display is lit up or flashing ⇒ Coolant temperature display .

Oil temperature display: the needle is in the middle area under normal driving conditions. If the needle is in the bottom left area, this means that the engine has not yet reached its operating temperature. Avoid excessively high speeds and acceleration when the engine has not yet reached

its operating temperature. The needle may move further in a clockwise direction under high engine loads and at high outside temperatures. This is no cause for concern unless the  indicator lamp in the instrument cluster display is lit up or flashing ⇒ Engine oil .

Adapting the display areas to the driving situation

Choose the three possible instruments corresponding to your individual driving style and the driving situation.

 WARNING

Accidents and injuries can occur if the driver is distracted. Operating the Infotainment system can distract you from the road.

Always drive carefully and responsibly.

 NOTICE

When starting from cold, avoid high engine speeds, driving at full throttle and over-loading the engine.



Due to the principle of performance determination used in the vehicle, the physical accuracy of the displayed values is not guaranteed.

Lap timer



First read and observe the introductory information and safety warnings ⇒  Introduction

The lap timer provides you with the option of timing your own laps manually in the vehicle on a race track, storing the times and comparing them with previously measured best times.



Fig. 24 On the Infotainment system display: lap timer with stopwatch, function button and lap times.

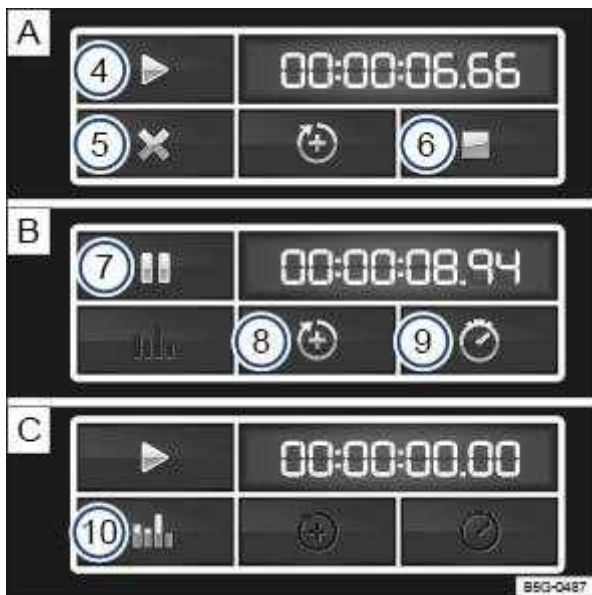

Fig. 25 Function button on the Infotainment system display: time measurement for paused, current and completed lap.

Key to ⇒ Fig. 24 and ⇒ Fig. 25

- ① Stopwatch.
- ② Function button with current lap time.
- ③ Stored lap times.
- ④ Start or continue time measurement (possible only when the ignition is switched on). Press Start to start time measurement. Time measurement starts automatically as soon as the vehicle moves forwards. A new first lap can be started when the data in the statistics have been reset.
- ⑤ Cancel current lap. The lap time is deleted. --:--:--.-- is displayed in the statistics.
- ⑥ End time measurement.
- ⑦ Pause time measurement or cancel current lap (when time measurement is running).
- ⑧ Start new lap. The last lap time is stored and a new lap starts. The overall time of the laps driven is shown in the statistics.
- ⑨ Display split time. The stopwatch stops for a few seconds and the split time is displayed.
- ⑩ Display statistics after ending or aborting time measurement (number of laps, overall time, fastest and slowest laps, average value of all lap times, all lap values). Press Reset to reset the statistics.

A maximum of 99 laps and a maximum time of 99 hours, 59 minutes and 59 seconds can be recorded. If one of these limits has been reached, the data in the statistics must be deleted before a further time measurement.

Opening the lap timer

Press the MENU button or function button, depending on the version of the Infotainment system.

Touch the Vehicle function button.

Touch the Selection function button.

Touch the Sport function button. The performance monitor is displayed.

Touch one of the arrow buttons ⇒ Fig. 23 ② in the performance monitor to change to the lap timer.

You can change between the lap timer and performance monitor at any time using the arrow buttons ⇒ Fig. 23 ② and ⇒ Fig. 24 .

Measuring lap times

The stopwatch measures the lap time in two areas:

The red needle and the numerical value in the centre show the running time in seconds. The smaller display in the inner area shows minutes and hours.

The display on the right side shows the current lap time with an accuracy of 1/100 seconds. There is no difference between the stopwatch and lap times if there are not yet any laps with split times stored in the lap timer.

WARNING

Avoid operating the lap timer when the vehicle is in motion if possible.

Make lap timer settings and access statistics only when the vehicle is stationary.

When the vehicle is in motion, use the lap timer only in driving situations which are easy to control.

Personalisation



First read and observe the introductory information and safety warnings ⇒  Introduction

The personalisation function allows personalised vehicle settings, such as air conditioning system, instrument cluster or lighting settings, to be saved in a user account. Four user accounts are available. Users are identified by the vehicle keys upon unlocking the vehicle. A user account is assigned to each vehicle key.

Changes to the settings will be assigned to the active user account and saved upon locking the vehicle or changing the user account.

Welcome and user account selection

When personalisation is activated, the name of the current user account appears on the instrument cluster display for approximately ten seconds after you switch on the ignition.

During this time, you can select a user account using the buttons on the wiper lever or multifunction steering wheel ⇒ Infotainment system controls and displays .

When you select a user account, the saved vehicle settings are activated.

User management and settings

When the ignition is switched on, you can use the Personalisation menu in the Infotainment system for user management and to make settings. The menu can be accessed via the vehicle settings in the Infotainment system.

Changing the user account

You can select the user account either via the Personalisation menu or via the Vehicle status menu.

Manually assigning vehicle keys to user accounts

You can assign a vehicle key to the currently active user account. For this purpose, select Manual key assignment.

Automatically assigning vehicle keys to user accounts

If you have selected Automatic key assignment, the following vehicle key is assigned to the user account upon changing the user account:

Vehicles without Keyless Access: vehicle key used to unlock the vehicle.

Vehicles with Keyless Access: vehicle key that is identified first by the personalisation function when you open the driver door.

Personalised vehicle settings

Opening and closing (single door unlocking, window convenience opening etc.)

Light and vision (daytime running lights, cornering light, lane change flash etc.)

Settings for air conditioning system

Active driver assist systems

Driving profile selection

Multifunction display and instrument cluster (selection of displays)

Infotainment system (display brightness and station sorting)



A new vehicle key will be assigned to the current user account. To assign the vehicle key to a different user account, select the required user account and manually assign it to the vehicle key.

Safety

General notes

Checklist

Observe the following information both before and during every journey to ensure your own safety, and the safety of all passengers and other road users ⇒ ⚠ :



Check that all lights and turn signals are working properly.



Check the tyre pressure and fuel level Tyre pressure, Fuel gauge.



Check the washer fluid level Washer fluid.



Make sure that you have a good, clear view through all of the windows Caring for and cleaning the vehicle exterior.



Secure any objects and luggage in the stowage compartments, the luggage compartment or on the roof Transporting items.



Ensure that you are able to operate the pedals freely at all times.



Secure any children travelling in the vehicle in a restraint system suitable for their weight and size Safe transport of children.



Adjust the front seats, head restraints and mirrors properly to match the size of the occupants Sitting position, Mirrors.



Wear shoes that provide proper support for your feet when using the pedals.



The floor mat in the footwell on the driver side must leave the pedal area free and must be securely fastened.



Assume a correct sitting position before setting off and maintain this position while driving. This also applies to all passengers Sitting position.



Fasten your seat belt correctly before setting off and keep it properly fastened throughout the journey. This also applies to all passengers Seat belts.



Each vehicle occupant must sit in a seat of their own and must have their own seat belt.



Never drive if your driving ability is impaired, e.g. by medication, alcohol or drugs.



Do not allow yourself to be distracted from the traffic, e.g. by passengers, telephone calls, opening menus and making adjustments to settings.



Always adapt your speed and driving style to suit visibility, weather, road and traffic conditions.



Observe traffic regulations and speed limits.



Take regular breaks when travelling long distances – at least every two hours.



Secure animals in the vehicle using a system that is suitable for their weight and size.

Checklist

In some countries, special safety standards and emissions-related legislation apply that may differ from the build status of the vehicle. Volkswagen recommends that you visit your Volkswagen dealership before travelling abroad to find out about any legal requirements and the following issues at your destination:



Does the vehicle need any technical modifications for driving abroad, e.g. masking or switching the headlights over?



Are the necessary tools, diagnosis equipment and spare parts available for service and repair work?



Are there any Volkswagen dealerships in the destination country?



Is fuel in the adequate quality available Fuel and emission control?



Are the correct service fluids that comply with Volkswagen specifications available in the destination country Service fluids and consumables?



Will the navigation function in the factory-fitted Infotainment system work with the available navigation data in the destination country?



Are special tyres necessary for travelling in the destination country?



Is a fire extinguisher a requirement in your destination country?



Which requirements must be observed regarding high-visibility waistcoats?

Checklist

Do not work on the engine and in the engine compartment unless you are familiar with the task, are aware of the general safety procedures and have the correct equipment, service fluids and suitable tools ⇒ In the engine compartment ! The work should be carried out by a qualified workshop if you are uncertain. Make sure you check the following on a regular basis:



Washer fluid level Washer fluid



Engine oil level Engine oil



Coolant level Coolant



Brake fluid level Brake fluid



Tyre pressure Wheels and tyres

Vehicle lighting Lights necessary for traffic safety:

Turn signals

Side lights, dipped beam headlights and main beam headlights

Tail light clusters

Brake lights

Rear fog light

Number plate light

Information on changing bulbs ⇒ Changing bulbs .



Please observe important safety information about the front passenger front airbag ⇒ Fitting and using child seats .



Driving under the influence of alcohol, drugs, medication or narcotics could cause accidents and fatal injuries.

Alcohol, drugs, medication and narcotics can severely impair senses, reaction times and driving safety. This could cause you to lose control of the vehicle.



Always observe current traffic regulations and speed limits, and think ahead when driving. The correct interpretation of the driving situation can make the difference between reaching your destination safely and having an accident with serious injuries.



Volkswagen is not responsible for any vehicle damage caused by low-quality fuel, inadequate servicing work or non-availability of Genuine Parts.



Observe the instructions and information for vehicles with an N1 approval ⇒ Information about vehicles with N1 approval (light commercial vehicle) .



Servicing the vehicle is not only about vehicle maintenance – it also ensures that your vehicle remains roadworthy and in perfect working order. You should therefore have your vehicle serviced according to the Volkswagen guidelines. Some work may have to be carried out before the date of the next service if the vehicle is subjected to severe operating conditions. Severe operating conditions are, for example, regular stop-and-go driving or driving in areas with high levels of dust. Further information can be obtained from your Volkswagen dealership or qualified workshop.

Sitting position



Introduction

This chapter contains information on the following subjects:

⇒ Dangers of assuming an incorrect sitting position

⇒ Correct sitting position

Number of seats

The vehicle has a total of five seats: two at the front and three at the rear.

Each seat is equipped with a seat belt.



WARNING

Assuming an incorrect sitting position in the vehicle can increase the risk of severe or fatal injuries during a sudden driving or braking manoeuvre in the event of a collision or accident or if the airbags are triggered.

All vehicle occupants must assume a correct sitting position before setting off and maintain this position throughout the trip. This also applies for the fastening of seat belts.

The number of vehicle occupants must never exceed the number of seats with seat belts in the vehicle.

Always secure children in the vehicle in an authorised child restraint system which is suitable for their height and weight ⇒ Safe transport of children and ⇒ Airbag system .

Always keep your feet in the footwell while the vehicle is in motion. Never place your feet on the seat or dash panel, for example, and never ride with your feet out of the window. The airbag and seat belt can otherwise not provide optimal protection and can actually increase the risk of injury during an accident.

Dangers of assuming an incorrect sitting position



First read and observe the introductory information and safety warnings ⇒  Introduction

If the seat belts are not worn or are worn incorrectly, the risk of severe or fatal injuries increases. Seat belts can provide optimal protection only if seat belt routing is correct. An incorrect sitting position considerably impairs the level of protection provided by a seat belt. This could lead to severe or even fatal injuries. The risk of severe or fatal injuries is especially increased when a

deploying airbag strikes a vehicle occupant who has assumed an incorrect sitting position. The driver is responsible for all occupants transported in the vehicle, especially children.

The following list contains examples of sitting positions that can be dangerous for all vehicle occupants.

Whenever the vehicle is in motion:

Never stand in the vehicle.

Never stand on the seats.

Never kneel on the seats.

Never tilt the backrest too far to the rear.

Never lean against the dash panel.

Never lie on the seats in the passenger compartment and on the rear bench seat.

Never sit on the front edge of a seat.

Never sit sideways.

Never lean out of a window.

Never put your feet out of a window.

Never put your feet on the dash panel.

Never place your feet on the seat cushion or seat backrest.

Never travel in a footwell.

Never sit on the armrests.

Never travel on a seat without wearing the seat belt.

Never travel in the luggage compartment.

 **WARNING**

Every incorrect sitting position in the vehicle increases the risk of severe or fatal injuries in the event of an accident or sudden driving or braking manoeuvre.

All vehicle occupants must maintain a correct sitting position and wear their seat belt properly while the vehicle is in motion.

Sitting in an incorrect position, not fastening the seat belt, or not leaving adequate space between the occupants and the airbags could inflict critical or fatal injuries, especially if the airbags deploy and strike an occupant who has assumed an incorrect sitting position.

Correct sitting position

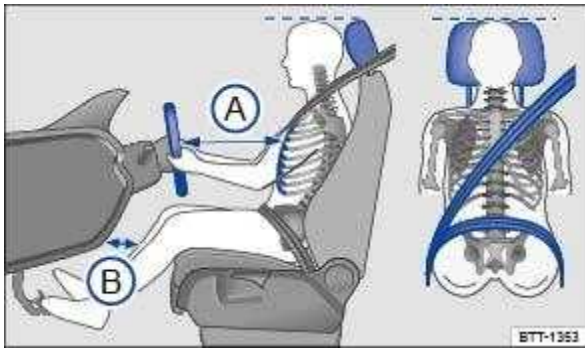

Fig. 26 Illustration: correct distance between the driver and the steering wheel, correct seat belt routing and correct head restraint adjustment.



First read and observe the introductory information and safety warnings ⇒ ⚠ Introduction

The correct sitting positions for the driver and passengers are described below.

If any vehicle occupants cannot assume a correct sitting position due to their physical build, they should contact a qualified workshop to find out about possible special modifications. The seat belts and airbags can only provide a maximum level of protection if a correct sitting position is assumed. Volkswagen recommends using a Volkswagen dealership for this purpose.

Volkswagen recommends the following sitting positions for your own safety and to reduce the level of injury in the event of a sudden braking manoeuvre or an accident:

The following applies to all vehicle occupants:

Adjust the head restraint so that its upper edge is at the same height as the top of the head, but not lower than eye level. Position the back of your head as close to the head restraint as possible at all times ⇒ Fig. 26 .

For small people, push the head restraint all the way down, even if the head is then located underneath the top edge of the head restraint.

For taller people, push the head restraint up as far as it will go.

Keep both feet in the footwell while the vehicle is in motion.

Adjust and fasten seat belts properly ⇒ Seat belts .

Additional points for the driver:

Move the backrest into an upright position so that your back rests fully against it.

Adjust the steering wheel so that the distance between the steering wheel and your breastbone is at least 25 cm ⇒ Fig. 26Ⓐ , and the circumference of the steering wheel can be held at the sides with both hands and your arms slightly bent ⇒ Steering wheel .

The steering wheel must always point towards the breastbone and not towards the face.

Adjust the driver seat by moving it forwards or backwards so that you are able to press the pedals to the floor with your knees still slightly bent and so that the distance from the dash panel to your knees is at least 10 cm ⇒ Fig. 26Ⓑ .

Adjust the height of the driver seat so that you can reach the highest point of the steering wheel.

Always leave both feet in the footwell in order to maintain control over the vehicle at all times.

Additional points for the front passenger:

Move the backrest into an upright position so that your back rests fully against it.

Push the front passenger seat as far back as possible so that the airbag can provide maximum protection if it is deployed.

Seat belts



Introduction

This chapter contains information on the following subjects:

- ⇒ Warning lamp
- ⇒ Frontal collisions and the laws of physics
- ⇒ What happens to vehicle occupants who have not fastened their seat belts
- ⇒ Seat belt protection
- ⇒ Using seat belts
- ⇒ Fastening and unfastening seat belts
- ⇒ Seat belt routing
- ⇒ Seat belt height adjuster
- ⇒ Belt retractor, belt tensioner, belt tension limiter
- ⇒ Service and disposal of belt tensioners
- ⇒ Proactive occupant protection system

Regularly check the condition of all seat belts. If the belt webbing, belt connections, belt retractor or seat belt buckle become damaged, the seat belt in question should be replaced immediately by a qualified workshop ⇒ ⚠. The qualified workshop must use the correct spare parts which are compatible with the vehicle, equipment level and model year. Volkswagen recommends using a Volkswagen dealership for this purpose.



WARNING

Incorrectly fastened or unfastened seat belts increase the risk of severe or fatal injuries. Seat belts will only offer the optimum level of protection when they are fastened and used properly.

Seat belts are the most effective means of reducing the risk of serious and fatal injuries in the event of an accident. Seat belts must always be fastened properly when the vehicle is in motion to protect the driver and all vehicle occupants.

Before every trip, each vehicle occupant must adopt the correct sitting position, correctly fasten the seat belt belonging to their seat and keep it fastened properly throughout the trip. This applies to all vehicle occupants and also in urban traffic.

While the vehicle is in motion, secure all children travelling in the vehicle in a restraint system suitable for their weight and height. They must also wear correctly fastened seat belts ⇒ Safe transport of children .

Drive off only when all passengers have correctly fastened their seat belts.

Never insert the latch plate into a buckle which does not belong to the corresponding seat and always ensure it engages properly. Using a buckle which does not belong to the seat you are occupying reduces the level of protection and can lead to severe injuries.

Never let any foreign bodies or liquids get into the slots for the belt buckles. This could prevent the belt buckle and seat belt from working properly.

Never unfasten the seat belt while the vehicle is in motion.

Never allow more than one person to share the same seat belt.

Never travel when children or babies are being carried on somebody's lap and fastened with the same belt.

Never travel wearing loose, bulky clothing (such as an overcoat over a jacket). This could prevent the seat belts from fitting and functioning properly.

 **WARNING**

Damaged seat belts are very dangerous and could cause severe or fatal injuries.

Never damage the belt by trapping it in the door or in the seat mechanism.

If the belt webbing or any other part of the seat belt becomes damaged, the seat belts may tear during an accident or sudden braking manoeuvre.

Have damaged seat belts immediately replaced by new seat belts that have been approved by Volkswagen for the vehicle. Seat belts subjected to stress and stretched during an accident must be replaced by a qualified workshop. Renewal may be necessary even if there is no apparent damage. The belt anchorage should also be checked.

Never try to repair, modify or remove the seat belts yourself. All repairs to the seat belts, belt retractors and buckles must be carried out by a qualified workshop.

Warning lamp



Fig. 27 On the instrument cluster display: warning lamp.



Fig. 28 On the instrument cluster display: seat belt status for the rear seats.





First read and observe the introductory information and safety warnings ⇒ Introduction

A signal tone will sound for a few seconds if the seat belts are not fastened as the vehicle pulls off and reaches a speed of more than approximately 25 km/h (15 mph), or if the seat belts are unfastened while the vehicle is in motion. This is accompanied by the flashing warning lamp  ⇒ Fig. 27 .

The warning lamp  does not go out until the driver and front passenger fasten their seat belts while the ignition is switched on.

Belt status display for the rear seats

After the ignition has been switched on, the belt status display ⇒ Fig. 28 on the instrument cluster display shows the driver whether the rear seat passengers have fastened their seat belts. The symbol  indicates that the passenger on this seat has fastened their seat belt. The symbol  indicates that the seat belt has not been fastened.

The belt status display will be shown for approximately 30 seconds if a seat belt is fastened or unfastened on the rear seats. The display is hidden automatically after 30 seconds.

If a seat belt for one of the rear seats is unfastened while the vehicle is in motion, the belt status display will flash for a maximum of 30 seconds. If the vehicle is travelling faster than approximately 25 km/h (15 mph), a signal tone will also be given.

WARNING

Incorrectly fastened or unfastened seat belts increase the risk of severe or fatal injuries. Seat belts will only offer the optimum level of protection when they are fastened and used properly.

Frontal collisions and the laws of physics

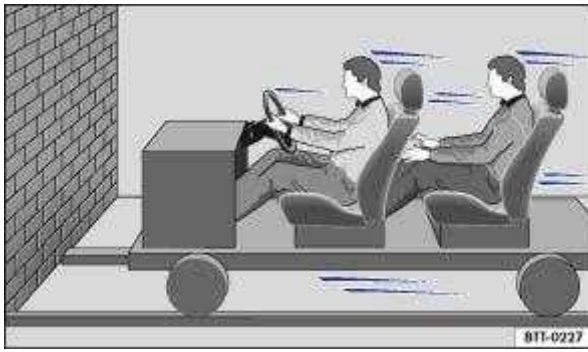

Fig. 29 Unbelted occupants in a vehicle heading towards a brick wall.

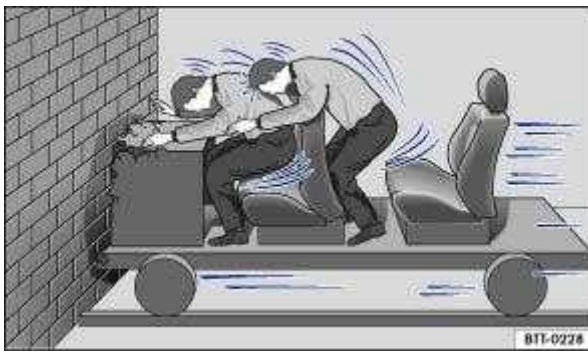

Fig. 30 Unbelted occupants in a vehicle striking a brick wall.



First read and observe the introductory information and safety warnings ⇒ Introduction

The physical principles involved in a frontal collision are relatively simple. As soon as the vehicle is in motion ⇒ Fig. 29 , both the moving vehicle and its passengers gain kinetic energy.

The higher the vehicle speed and the heavier the weight of the vehicle, the greater the amount of energy that will have to be released in the event of an accident.

The most significant factor, however, is the speed of the vehicle. For example, if the speed doubles from 25 km/h to 50 km/h (15 mph to 31 mph), the kinetic energy increases by a factor of four.

The amount of kinetic energy depends on the speed of the vehicle and the weight of the vehicle and passengers. The higher the speed and the greater the weight, the more energy there is to be released in an accident.

Passengers who are not wearing seat belts are not attached to the vehicle. In the event of a frontal collision, they will continue to move forwards at the same speed at which the vehicle was travelling before impact, until something stops them. Because the vehicle occupants in our example are not restrained by seat belts, their entire kinetic energy will be released only at the point of impact against the wall ⇒ Fig. 30 .

Even at speeds of approximately 30 km/h (19 mph) to approximately 50 km/h (31 mph), the forces acting on bodies in a collision can easily exceed one tonne (1,000 kg). These forces are even greater at higher speeds.

This example applies not only to frontal collisions, but to all accidents and collisions.

What happens to vehicle occupants who have not fastened their seat belts



Fig. 31 An unbelted driver is thrown forward.



Fig. 32 The unbelted rear passenger is thrown forward and strikes the belted driver.



First read and observe the introductory information and safety warnings ⇒ ⚠ Introduction

Many people believe that the occupants can brace their weight with their hands in a minor collision. This is not true.

Even at low speeds, the forces acting on the body in a collision are so great that it is not possible to brace yourself with your arms and hands. In a frontal collision, vehicle occupants who have not fastened their seat belts will be thrown forward and will make unchecked contact with parts of the vehicle interior, e.g. the steering wheel, dash panel, or windscreen ⇒ Fig. 31 .

The airbag system is not a substitute for the seat belts. Airbags provide only additional protection when deployed. Airbags will not be triggered in all kinds of accidents. Even if the vehicle is equipped with an airbag system, all vehicle occupants, including the driver, must fasten their seat belt and wear it correctly while the vehicle is in motion. This will reduce the risk of severe or fatal injuries in the event of an accident – regardless of whether an airbag is fitted for the seat.

An airbag can be triggered only once. To achieve the best possible protection, the seat belt must always be worn properly so that you will be protected in accidents in which no airbag is deployed. Any vehicle occupants not wearing a seat belt can be thrown out of the vehicle and sustain more severe or even fatal injuries as a result.

It is also important for the rear seat occupants to wear seat belts properly, as they could otherwise be thrown forwards violently in an accident. Rear seat passengers who are not wearing seat belts endanger not only themselves and the driver, but also other people in the vehicle ⇒ Fig. 32 .

Seat belt protection



Fig. 33 Driver restrained by a properly worn seat belt during a sudden braking manoeuvre.



First read and observe the introductory information and safety warnings ⇒ ⚠ Introduction

Properly worn seat belts can make a major difference. When worn correctly, seat belts hold the vehicle occupants in the correct sitting positions and considerably reduce the kinetic energy in the event of an accident. Seat belts also help to prevent uncontrolled movements that could lead to severe injuries. In addition, wearing seat belts properly reduces the risk of being thrown from the vehicle ⇒ Fig. 33 .

Passengers wearing seat belts correctly benefit greatly from the ability of the belts to reduce the kinetic energy. The front crumple zones and other passive safety features (such as the airbag system) are also designed to reduce kinetic energy. The amount of energy generated will thus decrease, thereby reducing the risk of injury.

The examples describe frontal collisions. Of course, properly worn seat belts also substantially reduce the risk of injury in all other types of accidents. This is why seat belts must be fastened before every trip – even if you are just driving round the corner. Ensure that all passengers also wear their seat belts properly.

Accident statistics have shown properly worn seat belts to be an effective means of substantially reducing the risk of injury and improving the chances of survival in a serious accident. Furthermore, properly worn seat belts improve the protection provided by airbags in the event of an accident. For this reason, wearing a seat belt is required by law in most countries.

Although the vehicle is equipped with airbags, the seat belts must be fastened and worn. For example, the front airbags will be triggered only in certain types of frontal collision. The front airbags will not be triggered as a result of minor frontal collisions, minor side collisions, rear collisions, rollover or accidents in which the airbag trigger threshold in the control unit is not exceeded.

Therefore, always wear your seat belt and ensure that your passengers have fastened their seat belts properly before you drive off!

Using seat belts



First read and observe the introductory information and safety warnings ⇒ ⚠ Introduction

Checklist

Using seat belts ⇒ ⚠ :



Regularly check the condition of all seat belts.



Keep the seat belts clean.



Avoid allowing any foreign bodies or fluids to get on to the seat belt or latch plate or into the slot for the seat belt buckle.



Do not trap or damage the seat belt and latch plate, for example when closing the door.



Never remove, modify or repair the seat belt or belt anchorage elements.



Always fasten the seat belt correctly before any journey and wear it properly while the vehicle is in motion.

Twisted seat belt

If it is difficult to pull the seat belt out of the belt guide, the seat belt may have become twisted in the side trim as a result of being retracted too quickly when unfastened:

Take hold of the latch plate, then slowly and carefully pull out the seat belt fully.

Untwist the seat belt and guide it back slowly by hand.

Fasten the seat belt even if you are unable to undo the twist. However, the twist should not be in part of the seat belt which comes into direct contact with the body. The twist should be corrected immediately by a qualified workshop.



WARNING

Using seat belts incorrectly increases the risk of severe or fatal injuries.

Regularly check to ensure that the seat belt and its related parts are in perfect condition.

Always keep the seat belt clean.

Do not allow the belt webbing to become jammed, damaged or to rub on any sharp edges.

Always keep the latch plate and slot in the buckle free from foreign bodies and liquids.

Fastening and unfastening seat belts

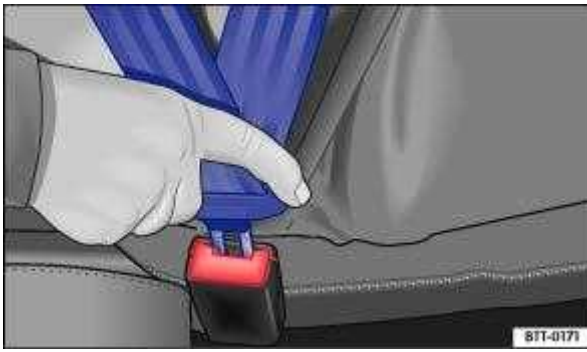

Fig. 34 Inserting the seat belt latch plate into the buckle.



Fig. 35 Removing the latch plate from the buckle.



First read and observe the introductory information and safety warnings ⇒ Introduction

If worn properly, seat belts hold the vehicle occupants in the correct sitting position during an accident or braking manoeuvre, providing maximum protection ⇒ .

In vehicles with a proactive occupant protection system, the driver and front passenger seat belts are automatically tensioned in certain situations ⇒ Proactive occupant protection system .

In addition, belt slack can be minimised.

Fastening seat belts

Fasten seat belts before every trip.

Adjust the front seat and head restraint correctly ⇒ Sitting position .

Engage the rear seat backrest in an upright position ⇒ .

Take hold of the belt and pull it evenly across your chest and pelvis. Do not twist the belt in the process ⇒ .

Insert the latch plate securely into the buckle belonging to the occupied seat ⇒ Fig. 34 .

Pull on the seat belt to ensure that the latch plate is securely locked in the buckle.

Unfastening seat belts

Unfasten seat belts only when the vehicle is stationary ⇒ .

Press the red button in the buckle ⇒ Fig. 35 . The latch plate is released and springs out.

Guide the belt back by hand so that it rolls up easily, without twisting the seat belt and without damaging the trim.

 **WARNING**

Incorrect seat belt routing can cause severe or fatal injuries in the event of an accident.

The seat belts offer best protection only when the backrests are in an upright position and the seat belts have been fastened properly according to the occupant's size.

Unfastening seat belts while the vehicle is in motion can lead to severe or fatal injuries in the event of an accident or sudden braking manoeuvre.

Seat belt routing

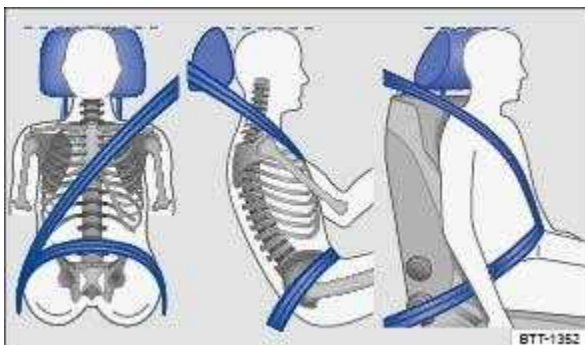

Fig. 36 Correct seat belt routing and head restraint adjustment.



Fig. 37 Correct seat belt routing for pregnant women.

 First read and observe the introductory information and safety warnings ⇒  Introduction

Seat belts will offer an optimum level of protection during an accident only when they are routed correctly. Correct seat belt routing reduces the risk of severe or fatal injuries. Correct seat belt routing also holds the vehicle occupants in position so that a deployed airbag can offer the maximum level of protection. This is why you must always fasten your seat belt and ensure that the seat belt routing is correct ⇒ Fig. 36 .

An incorrect sitting position can cause severe or fatal injuries ⇒ Sitting position .

Correct seat belt routing

The shoulder part of the seat belt must always lie on the centre of the shoulder, never across the neck, over or under the arm or behind the back.

The lap part of the seat belt must always lie across the pelvis, never across the stomach.

The seat belt must always lie flat and snugly on the body. Tighten the belt slightly if necessary.

For pregnant women, the seat belt must be positioned evenly over the chest and as low as possible over the pelvis. It must also lie flat so that no pressure is exerted on the abdomen – this applies in every stage of pregnancy ⇒ Fig. 37 .

Adjusting seat belt routing to body size

The following equipment can be used to adjust the seat belt routing:

Seat belt height adjuster for the front seats ⇒ Seat belt height adjuster .

Height-adjustable front seats ⇒ Sitting position .

WARNING

Incorrect seat belt routing can cause severe injuries in the event of an accident or a sudden braking or driving manoeuvre.

The seat belts offer best protection only when the backrests are in an upright position and the seat belts have been fastened properly.

The seat belt itself or a loose seat belt can cause serious injuries if the seat belt shifts from harder body parts in the direction of softer body parts (e.g. stomach).

The shoulder part of the seat belt must lie on the centre of the shoulder and never under the arm or across the neck.

The seat belt must lie flat and snugly on the upper body.

The lap part of the seat belt must lie across the pelvis and never across the stomach. The seat belt must lie flat and snugly on the pelvis. Tighten the belt slightly if necessary.

For pregnant women, the lap part of the seat belt must be as low as possible over the pelvis and lie flat around the round stomach.

Do not twist the belt webbing while the seat belt is being worn.

Never hold the seat belt away from the body by hand.

The belt webbing should not lie over hard or fragile objects, such as glasses, pens or keys.

Never use seat belt clips, retaining rings or similar items to alter the seat belt routing.



If a person's physical build prevents them from routing the seat belt properly, contact a qualified workshop to find out about any special modifications so that the seat belts and airbags can provide

the optimum level of protection. Volkswagen recommends using a Volkswagen dealership for this purpose.

Seat belt height adjuster

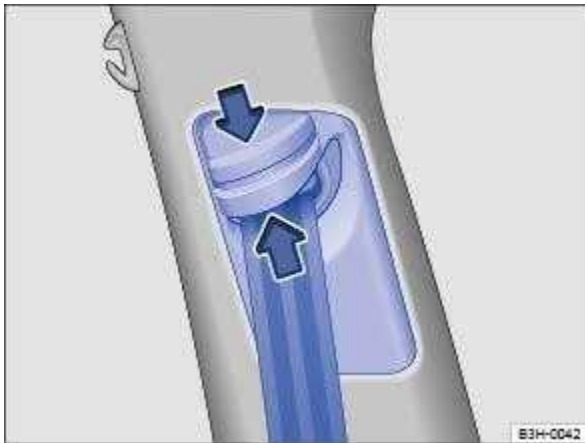

Fig. 38 Next to the front seats: seat belt height adjuster.



First read and observe the introductory information and safety warnings ⇒ ⚠ Introduction

The seat belt height adjusters for the front seats can be used to adjust the position of the seat belt on the shoulder so that it can be fastened properly:

Push the shoulder belt guide together in the direction of the arrows and hold ⇒ Fig. 38 .

Push the shoulder belt guide up or down so that the seat belt runs over the middle of the shoulder ⇒ Seat belt routing .

Release the shoulder belt guide.

Pull sharply on the seat belt to check whether the shoulder belt guide is engaged securely.

⚠ WARNING

Never adjust the seat belt height when the vehicle is in motion.

Belt retractor, belt tensioner, belt tension limiter



First read and observe the introductory information and safety warnings ⇒ ⚠ Introduction

The seat belts in the vehicle are part of the vehicle safety concept ⇒ Airbag system and include the following important functions:

Belt retractor

Every seat belt is equipped with a belt retractor on the shoulder part of the belt. Full freedom of movement is guaranteed when the shoulder belt is pulled slowly or when the vehicle is travelling at normal speeds. However, the belt retractor is locked if the belt is pulled out quickly or during sudden braking, on inclines, in bends and during acceleration.

Belt tensioner

The belt tensioners are activated by sensors in the event of severe frontal, side and rear collisions. They tighten the seat belts against the direction in which they are pulled. Any slack in the seat belt is retracted, which can reduce the forward movement of the vehicle occupants and their movement in the direction of the impact. The belt tensioner works together with the airbag system. If the vehicle rolls over, the belt tensioners will not be activated if the side airbags are not triggered.

Fine dust may be produced when belt tensioners are triggered. This is quite normal and does not mean there is a fire in the vehicle.

Belt tension limiter

The belt tension limiter reduces the pressure exerted by the seat belt on the body in an accident.



All safety regulations must be observed when the vehicle or components of the system are scrapped. Qualified workshops are familiar with these regulations ⇒ Service and disposal of belt tensioners .

Service and disposal of belt tensioners



First read and observe the introductory information and safety warnings ⇒  Introduction

Seat belts may become damaged during any work on the belt tensioners or while removing or refitting any vehicle parts in conjunction with any other repair work. This damage will not always be noticeable. The consequence may be that the belt tensioners could function incorrectly, or not function at all, in the event of an accident.

Regulations must be observed to ensure that the effectiveness of the belt tensioner is not reduced and that removed parts do not cause any injuries or environmental pollution. Qualified workshops are familiar with these regulations.



WARNING

The risk of severe or fatal injuries may be increased if the seat belts, belt retractors and belt tensioners are not used correctly or if they are repaired by a non-professional. As a result, the belt tensioners may not be triggered when they should be, or they may be triggered unexpectedly.

Any repairs, adjustments or removal and refitting of parts in the belt tensioners or seat belts should always be carried out by a qualified workshop and never by yourself ⇒ Accessories, modifications, repairs and renewal of parts .

Belt tensioners and belt retractors cannot be repaired. They must be replaced.



The airbag modules and belt tensioners may contain perchlorate. Observe the applicable legislation regarding disposal.

Proactive occupant protection system



First read and observe the introductory information and safety warnings ⇒  Introduction

The proactive occupant protection system is an assistance system that initiates measures to protect vehicle occupants in dangerous situations. However, the system cannot prevent a collision.

The full range of functions of the proactive occupant protection system will be available only if the function has been activated in the Infotainment system, no special driving profile has been selected and there are no malfunctions ⇒ Driving profile selection and 4MOTION Active Control, ⇒ Function limitations.

Basic functions

Depending on country-specific legal requirements and also on the vehicle equipment, the following functions may be initiated, either individually or jointly, in critical situations (e.g. emergency braking or in the case of oversteering or understeering) as of a speed of approximately 30 km/h (19 mph):

Reversible tensioning of the fastened front seat belts.

Depending on the critical driving situation, the seat belts can be tensioned separately or together.

Additional information for vehicles with an area monitoring system (Front Assist)

In vehicles fitted with the area monitoring system (Front Assist) ⇒ Area monitoring system (Front Assist), the probability of a collision with the vehicle ahead is also calculated within the system limits. The system can trigger the proactive occupant protection system if it detects a probable collision or initiates strong braking.

Function limitations

The proactive occupant protection system will not be available, or will be available only to a limited extent, in the following situations:

If there is a fault in the ESC, belt tensioner ⇒ Seat belts or airbag control unit ⇒ Airbag system.



WARNING

The intelligent technology of the proactive occupant protection system cannot overcome the laws of physics, and functions only within the limits of the system. Never let the extra convenience afforded by the proactive occupant protection system tempt you into taking any risks when driving. The system cannot prevent a collision. The system is not a substitute for the full concentration of the driver.

Adapt your speed and distance from the vehicles ahead to suit visibility, weather, road and traffic conditions.

The system cannot detect objects in all situations.

The proactive occupant protection system does not react to people, animals, objects crossing in front of the vehicle, or objects which are hard to detect.

Reflective objects such as safety barriers, tunnel entrances, heavy rain and ice can impair the performance of the proactive occupant protection system and thus prevent it from detecting a collision risk.

Incorrect system activation can occur.



Accidents and injuries can occur if the driver is distracted.

Never change settings in the Infotainment system when the vehicle is in motion.



Failure to observe illuminated warning lamps and text messages can lead to your vehicle breaking down in traffic, and can cause accidents and serious injury.

Never ignore any illuminated warning lamps or text messages.

Stop the vehicle as soon as possible and when safe to do so.



Failure to observe illuminated indicator lamps and text messages can lead to your vehicle being damaged.

Airbag system



This chapter contains information on the following subjects:

⇒ Types of front passenger front airbag system

⇒ Indicator lamp

⇒ Description and function of the airbags

⇒ Front airbags

⇒ Switching the front passenger front airbag on and off

The vehicle is equipped with a front airbag for the driver and front passenger. The front airbags can provide front seat occupants with additional chest and head protection if the seat, seat belts, head restraints and, in the case of the driver, steering wheel are adjusted and used correctly. Airbags are designed only for additional protection. The airbag system is not a substitute for the seat belts. Seats belts must always be worn, even when the front seats are equipped with airbags.

 WARNING

Never rely on the airbag system exclusively for your protection.

The airbag has merely a supportive function for your protection, even if it is triggered.

The airbag system offers the best level of protection and reduces the risk of injury when seat belts are properly worn ⇒ Seat belts .

Before every trip, each vehicle occupant must adopt the correct sitting position, correctly fasten the seat belt belonging to their seat and keep it fastened properly throughout the trip. This applies to all vehicle occupants and also in urban traffic.

 WARNING

The risk of injury increases if there are any objects located between the vehicle occupants and the deployment area of the airbag when it is triggered. This will impinge on the deployment zone of the airbag or the items will be flung against the body.

Never hold any objects in your hands or on your lap while the vehicle is in motion.

Never transport any objects on the front passenger seat. The objects could enter into the deployment zone of the airbag during sudden braking or driving manoeuvres and then be flung dangerously through the vehicle interior if the airbag is activated.

Vehicle occupants sitting on the front seats and rear outer seats must never carry any people, pets or objects in the deployment zone between themselves and the airbags. Make sure that children and passengers also keep to this rule.

 WARNING

The airbag system can be triggered only once. The system will have to be replaced if the airbags have been triggered.

Airbags that have been triggered, and any affected system parts, must immediately be replaced with new parts that are approved by Volkswagen for the vehicle.

Repairs and modifications to your vehicle should be carried out only by a qualified workshop. Qualified workshops have the necessary tools, diagnostic equipment, repair information and qualified personnel.

Never use recycled airbag components or components that have been taken from end-of-life vehicles in your vehicle.

Never alter any components of the airbag system.

 WARNING

Fine dust particles or steam may be released when the airbags trigger. This is normal and does not mean there is a fire in the vehicle.

The fine dust can cause irritation to the skin and eye membranes as well as cause breathing difficulties, particularly for those people suffering from asthma or other respiratory health problems. In order to reduce breathing difficulties, get out of the vehicle or open the windows or doors in order to breathe fresh air.

If you should come into contact with the dust, you should wash your hands and face with a mild soap and water before eating.

Do not rub the dust into your eyes or into open wounds.

If dust has entered your eyes, rinse them with water.





 **WARNING**

Cleaning agents that contain solvents cause the surface of the airbag modules to become porous. In an accident that triggers the airbag, loose plastic parts can cause serious injury.

Never clean the dash panel or the airbag covers with cleaning agents that contain solvents.

Types of front passenger front airbag system

 First read and observe the introductory information and safety warnings ⇒  Introduction

Volkswagen offers two different front passenger front airbag systems:	
A	B
Features of the front passenger front airbag that can be switched off only by a qualified workshop.	Features of the front passenger front airbag that can be switched off manually using the key-operated switch ⇒ Switching the front passenger front airbag on and off .
Designation: airbag system.	Designation: airbag system with front passenger front airbag deactivation.
– Indicator lamp  lights up on the instrument cluster display.	– Indicator lamp  lights up on the instrument cluster display.
– Front passenger front airbag in the dash panel.	– Indicator lamp PASSENGER AIR BAG OFF  in the upper section of the centre console.
	– Indicator lamp PASSENGER AIR BAG ON  in the upper section of the centre console.
	– Key-operated switch in the side of the dash panel on the passenger side (visible only when the door is open).

Volkswagen offers two different front passenger front airbag systems:	
A	B
Features of the front passenger front airbag that can be switched off only by a qualified workshop.	Features of the front passenger front airbag that can be switched off manually using the key-operated switch ⇒ Switching the front passenger front airbag on and off .
	– Front passenger front airbag in the dash panel.

Indicator lamp

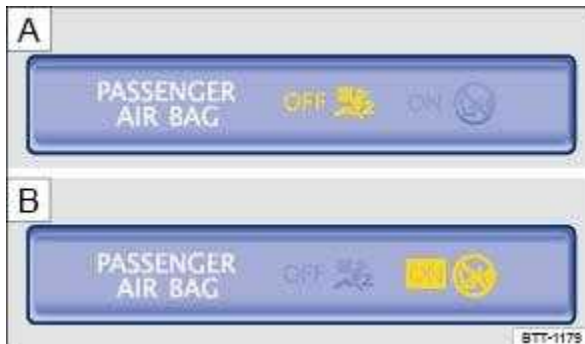

Fig. 39 In the roof console: indicator lamp for deactivated front passenger front airbag or indicator lamp for activated front passenger front airbag .

First read and observe the introductory information and safety warnings ⇒ Introduction

Several warning and indicator lamps will light up briefly as a functional check when the ignition is switched on. They will go out after a few seconds.

WARNING

If there is a fault in the airbag system, the airbag may not trigger correctly, may not trigger at all or may trigger unexpectedly. This could cause severe or fatal injuries.

The airbag system should be checked by a qualified workshop as soon as possible.

Never fit a child seat to the front passenger seat or remove a child seat that is already fitted! The front passenger front airbag may deploy during an accident in spite of the fault.

NOTICE

Failure to observe the illuminated indicator lamps could lead to the vehicle being damaged.

Description and function of the airbags

First read and observe the introductory information and safety warnings ⇒ Introduction

The airbags can protect vehicle occupants during frontal and side collisions by reducing their movement in the direction of the collision.

Each triggered airbag is filled by a gas generator. This causes the airbag covers to break open and the airbags inflate forcefully to cover their deployment zones within milliseconds. Once a vehicle occupant wearing a seat belt starts to sink into the inflated airbag, the gas inside the airbag starts to escape to cushion the occupant and slow down their movement. This reduces the risk of severe and fatal injuries. A triggered airbag will not always prevent other injuries from occurring, such as swelling, bruising, burning and grazing. Deployment of an airbag can also result in frictional heat.

The most important factors for triggering the airbag are the type of accident, the angle of impact, the vehicle speed and the type of object with which the vehicle collides. Therefore, visible damage to the vehicle does not always mean that the airbag should have been triggered.

The triggering of the airbag system depends on the vehicle deceleration rate caused by the collision and registered by the electronic control unit. If this rate is below the reference value programmed into the control unit, the airbags will not be triggered, even though the vehicle may be badly damaged as a result of the collision. Vehicle damage, repair costs or even the lack of vehicle damage in an accident is not necessarily an indication of whether an airbag should inflate or not. It is not possible to define a range of vehicle speeds and reference values, since the circumstances will vary considerably between one collision and another. It is therefore impossible to cover every possible kind and angle of impact that would trigger the airbags. Important factors in the triggering of the airbag include, for example, the nature (hard or soft) of the object that the vehicle hits, the angle of impact as well as vehicle speed.

Airbags serve only as a supplement to the three-point seat belt in some accident situations when the vehicle's deceleration is sufficient to trigger the airbags. Airbags can be triggered only once and only in certain situations. The seat belts are always there to provide protection in situations when the airbags are not triggered or have already been triggered. For example, if the vehicle collides with a further vehicle following the initial collision, or is hit by another vehicle.

The airbag system is part of the vehicle's overall passive safety concept. The airbag system can work effectively only when the occupants are wearing their seat belts correctly and have assumed a proper sitting position  ⇒ Sitting position .

Components of the vehicle safety concept

The following vehicle safety equipment makes up the vehicle's safety concept to reduce the risk of severe and fatal injuries. Depending on the vehicle equipment level, some of the equipment may not be fitted in your vehicle or may not be available in some countries.

Optimised seat belts for all seats.

Front airbags for driver and front passenger.

Airbag indicator lamp  .

Control units and sensors.

Adjustable steering column.

If applicable, mounting points for the top tether for child seats.

Front airbags



Fig. 40 Location and deployment zone of the driver front airbag.

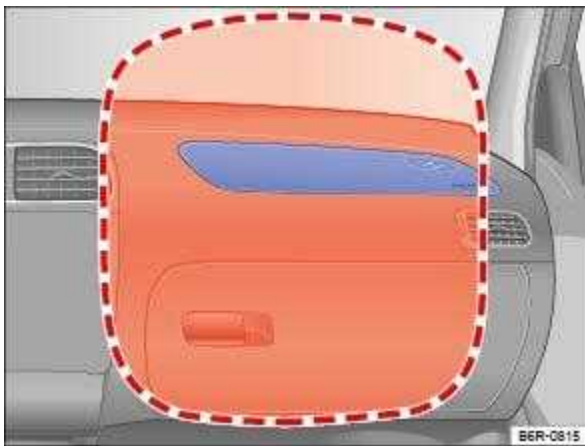



Fig. 41 Location and deployment zone of the front passenger front airbag.



First read and observe the introductory information and safety warnings ⇒  Introduction

In conjunction with the seat belts, the front airbag system gives the front occupants additional protection for the head and chest in the event of a severe frontal collision. Always keep as far away from the front airbag as possible ⇒ Sitting position . This allows the front airbags to deploy fully when they are triggered, thus providing maximum protection.

The front airbag for the driver is located in the steering wheel ⇒ Fig. 40 and the front airbag for the front passenger is located in the dash panel ⇒ Fig. 41 . The airbag locations are identified by the text AIRBAG.

The areas inside the red lines are covered by the front airbags when deployed (deployment zone). You must never leave or attach any objects in these areas ⇒  . Any factory-fitted add-on parts will not be struck if the driver and front passenger front airbags are deployed.

 DANGER

Once triggered, the airbag inflates in fractions of a second and at very high speed.

Always leave the deployment zones of the front airbags clear.

Never attach any objects, such as drink or telephone holders, to the covers of the airbags or anywhere in the airbag deployment zone.

No other people, animals or objects may be carried between the occupants of the front seats and the airbag deployment zone. Make sure that children and passengers also keep to this rule.

Do not attach any objects, e.g. mobile navigation devices, to the windscreen above the front airbag on the front passenger side.

Do not cover or stick anything on the steering wheel hub or the soft plastic surface of the airbag unit on the front passenger side, and do not obstruct or modify them in any way.

WARNING

The front airbags are deployed in front of the steering wheel ⇒ Fig. 40 and dash panel ⇒ Fig. 41 .

When driving, always hold the steering wheel with both hands on the outside of the rim at the 9 o'clock and 3 o'clock positions.

Adjust the driver seat so that there is at least 25 cm between your breastbone and the hub of the steering wheel. Contact a qualified workshop if your physical build makes this impracticable.

Adjust the front passenger seat so that the distance between the front passenger and the dash panel is as large as possible.

Switching the front passenger front airbag on and off



Fig. 42 In the dash panel on the front passenger side: key switch for disabling and enabling the front airbag on the front passenger side.

 First read and observe the introductory information and safety warnings ⇒  Introduction

The front passenger front airbag must be disabled if you fit a rear-facing child seat on the front passenger seat.

Enabling the front passenger front airbag

Switch off the ignition.

Open the door on the front passenger side.

Fold the key bit of the vehicle key all the way out ⇒ Vehicle key .

Insert the key bit into the key-operated switch on the dash panel ⇒ Fig. 42 until you feel the second point of resistance. Around three quarters of the key bit should be inserted in the key switch at this point ⇒  .

Turn the vehicle key, without using force, to the position  **ON**.

Remove the vehicle key from the key-operated switch and fold away the key bit ⇒  .

The PASSENGER AIR BAG **ON**  indicator lamp in the upper section of the centre console lights up and goes out after approximately 60 seconds ⇒ Indicator lamp .

Close the door on the front passenger side.

Check that the PASSENGER AIR BAG **OFF**  indicator lamp in the upper section of the centre console does not light up when the ignition is switched on ⇒ Indicator lamp .

Disabling the front passenger front airbag

Switch off the ignition.

Open the door on the front passenger side.

Fold the key bit of the vehicle key all the way out ⇒ Vehicle key .

Insert the fully folded-out key bit of the vehicle key into the key-operated switch in the dash panel ⇒ Fig. 42 up to the second point of resistance. Around three quarters of the key bit should be inserted in the key switch at this point ⇒  .



Turn the vehicle key, without using force, to the position  **OFF**.



Remove the vehicle key from the key-operated switch and fold away the key bit ⇒  .

Close the door on the front passenger side.

The PASSENGER AIR BAG **OFF**  indicator lamp in the upper section of the centre console lights up continuously when the ignition is switched on ⇒ Indicator lamp .

Indication that front passenger front airbag is disabled

A deactivated front passenger front airbag is indicated only by the continuously lit PASSENGER AIR BAG **OFF**  indicator lamp in the upper section of the centre console (**OFF**  lights up yellow continuously) ⇒ Indicator lamp .

If the PASSENGER AIR BAG **OFF**  indicator lamp in the upper section of the centre console does not light up continuously or lights up together with the  indicator lamp in the instrument cluster display, do not fit a child restraint system on the front passenger seat for safety reasons. The front passenger front airbag could trigger during an accident.

 WARNING

The front passenger front airbag should be switched off only in exceptional circumstances.

To prevent damage to the airbag system, switch the front passenger front airbag on and off only when the ignition is switched off.

It is the driver's responsibility to ensure that the key-operated switch is set to the correct position.

Switch off the front passenger front airbag only if in exceptional circumstances a child seat is fitted on the front passenger seat.

Switch the front passenger front airbag back on again as soon as the child seat on the front passenger seat is no longer being used.

 WARNING

Do not leave the vehicle key in the key switch while driving.

Strong vibrations may cause the vehicle key to turn in the key switch, which could cause the front passenger front airbag to be activated.

Untimely inflation of the front passenger front airbag could lead to serious or fatal injuries.

 NOTICE

If the key bit is not inserted far enough, the key switch could be damaged when the key is turned.

 NOTICE

Do not leave the vehicle key in the key switch, as this could result in damage to the interior door trim, dash panel, key switch or vehicle key when the front passenger door is closed.

Safe transport of children

 Introduction

This chapter contains information on the following subjects:

⇒ Types of child seat

⇒ Fitting and using child seats

⇒ Securing systems

⇒ Securing a child seat with ISOFIX

⇒ Securing child seats with a seat belt

Using child seats can reduce the risk of injury to the child if there is an accident. Always use child seats when driving with children.

Note the following:

Child seats are classified into groups depending on the size, age and weight of child for which they are designed.

Various securing systems are used to secure child seats in the vehicle.

For safety reasons, child seats must always be fitted to the rear seats ⇒ Fitting and using child seats .

Volkswagen recommends child seats from the Volkswagen range of accessories. These child seats have been developed and approved for use in Volkswagen vehicles.

WARNING

If children are not secured or are inadequately secured, they are at greater risk of serious or even fatal injury. Please note the following:

Children who are either under twelve years of age or less than 150 cm tall must not be carried in the vehicle if they are not secured in a suitable child seat while the vehicle is in motion. Regulations in some countries may differ and must be complied with.

Always secure children in the vehicle in a suitable child seat. The seat used must be appropriate to the child's height, weight and age.

Never fasten more than one child into one child seat.

Under no circumstances should children or babies be held in a passenger's or driver's lap while driving.

Never leave a child unsupervised in a child seat.

Never allow a child to be carried in a vehicle without being properly secured, and never allow a child to stand up or to kneel on a seat, or to sit incorrectly while the car is in motion. This is particularly important for children carried on the front passenger seat. In an accident, children may sustain serious injuries to themselves and others.

The child seat can provide maximum protection only if the seat belt is routed correctly around it. Always ensure that the seat belt is routed as specified in the instructions provided by the child seat manufacturer. If the seat belt is routed incorrectly, injuries may occur even in a minor accident.

After an accident, it is vital to replace any child seats that were in use during the accident, as they could have sustained non-visible damage.

Types of child seat



Fig. 43 Example illustrations of child seats.



First read and observe the introductory information and safety warnings ⇒ ⚠ Introduction

Use only child seats that have been officially approved and are suitable for the child.

Standards for child seats

The regulations (ECE-R 44 or ECE-R 1291) apply to child seats in the European Union. Both regulations apply in parallel. Child seats which have been tested in accordance with these standards carry an orange ECE approval label. This ECE approval label may include the following information about the child seat:

Weight class

Size class

Approval category (universal, semi-universal, vehicle-specific or i-Size)

Approval number

On child seats that are approved under regulation ECE-R 44, the eight-digit approval number on the ECE approval label must begin with 03 or 04. This shows that the seat is admissible for use. Older child seats with an approval number beginning with 01 or 02 are not permitted.

Child seats by weight class

Class	Child's weight
Group 0	up to 10 kg
Group 0+	up to 13 kg
Group 1	9 to 18 kg
Group 2	15 to 25 kg
Group 3	22 to 36 kg

Weight class 0/0+: group 0/0+ or 0/1 rear-facing infant carriers ⇒ Fig. 43 are the best option for the period from birth to about 18 months.

Weight class 1: group 1 (up to about four years old) and group 1/2 (up to about seven years old) with an integral belt system are best for children over the relevant weight limit.

Weight classes 2/3: groups 2 and 3 include child seats with a backrest, and booster seats with no backrest. Child seats with a backrest have integrated seat belt routing and side cushions, and so provide better protection than booster seats with no backrest. Volkswagen therefore recommends the use of child seats with a backrest. Group 2 child seats are for children up to the age of about seven, group 3 child seats for those older than seven.

Not every child will fit in the child seat specified for their weight group. Likewise, not every seat will fit in every vehicle. Therefore it is vital to check that the child fits properly in their child seat and that the child seat can be securely fastened in the vehicle.

Child seats by approval categories

Child seats can be classified as universal, semi-universal or vehicle-specific (all in accordance with regulation ECE-R 44), or as i-Size (in accordance with regulation ECE-R 129).

Universal: child seats with universal approval are approved for use in all vehicles. No type list is required. ISOFIX child seats with universal approval must also be secured using a strap over the top of the vehicle seat (top tether).

Semi-universal: semi-universal approval requires other safety devices for attaching the seat (that require additional testing) in addition to the standard requirements for universal approval. Child seats with semi-universal approval come with a type list. The seats should be used only in vehicles that are included on this list.

Vehicle-specific: child seats with vehicle-specific approval must have undergone dynamic testing in each model of vehicle for which they are approved. These child seats also come with a type list.

i-Size: child seats with i-Size approval must conform to the installation and safety requirements stipulated in regulation ECE-R 129. Contact the child seat manufacturer to find out which child seats are approved for this vehicle in accordance with i-Size.

1) Regulation ECE-R 129 has not yet been implemented by the state authorities in all countries.

Fitting and using child seats



Fig. 44 Illustration: airbag label on the sun visor.



Fig. 45 Illustration: airbag label on the B-pillar.

 First read and observe the introductory information and safety warnings ⇒  Introduction

Country-specific requirements

The standards and regulations governing the use of child seats and child seat securing mechanisms differ from country to country. Not all countries allow you to transport children on the front passenger seat. Legislation and legal requirements take precedence over the information given in this owner's manual.

Information on fitting a child seat

Observe the following general information when fitting a child seat. This information is relevant whatever child seat securing system is being used.

Read and follow the instructions provided by the child seat manufacturer ⇒  .

Whenever possible, fit all child seats to the rear seat behind the front passenger seat so that children can exit the vehicle on the kerb side.

Adjust the seat belt height adjuster to the highest position.

When fitting on the front passenger seat, push the front passenger seat back fully and adjust the seat to the highest position. Adjust the backrest to an upright position ⇒ Sitting position .

Always leave sufficient space around the child seat. If necessary, adjust the position of the seat in front of it. When doing so, ensure that the driver or front passenger can still maintain a correct sitting position ⇒ Sitting position .

The backrest of the child seat must lay as flat as possible against the vehicle seat backrest. If necessary, adjust the seat backrest angle so that the child seat lies flush against the backrest. Once it has been installed, if the child seat is touching the head restraint and therefore cannot be positioned flush against the backrest, push the head restraint all the way up, or remove it and stow it securely in the vehicle ⇒ Sitting position .

Airbag sticker

The vehicle may be provided with stickers giving important information about the front passenger front airbag. The information on these stickers may vary from country to country. The stickers may be provided at the following locations:



On the driver and/or front passenger sun visor ⇒ Fig. 44 .

On the B-pillar on the front passenger side ⇒ Fig. 45 .

It is essential to note the warning information shown on these stickers before installing a rear-facing child seat ⇒  .

Risks involved in carrying children on the front passenger seat

If you are using a rear-facing child seat, the front passenger front airbag can cause critical or potentially fatal injuries when it inflates ⇒  .

Rear-facing child seats may be used on the front passenger seat only if the front passenger front airbag has been deactivated. A deactivated front passenger front airbag is indicated by the continuously lit PASSENGER AIR BAG **OFF**  indicator lamp in the driver's field of vision. PASSENGER AIR BAG **OFF**  indicator lamp ⇒ Indicator lamp .

If using a front-facing child seat, do not deactivate the front passenger front airbag. When fitting the child seat, ensure that it is as far away as possible from the front passenger front airbag. The front passenger front airbag can cause severe injuries when it inflates ⇒  .

Some child seats are not suitable for use on the front passenger seat. The child seat must be specially approved by the manufacturer for use on the front passenger seat in vehicles with front and side airbags. Volkswagen dealerships keep an up-to-date list of approved child seats.

 DANGER

If you use a rear-facing child seat on the front passenger seat, the child in it is at increased risk of sustaining critical or fatal injuries in the event of an accident.

Deactivate the front passenger front airbag. If the front passenger front airbag cannot be deactivated, no rear-facing child seat may be used.

Move the front passenger seat as far back as possible and adjust to its highest position to create the largest possible distance between the child seat and the front passenger front airbag.

Move the backrest to the upright position.

Adjust the seat belt height adjuster to the highest position.

Use only child seats that have been approved by the child seat manufacturer for use on a front passenger seat with front and side airbags.

 WARNING

There is a risk of injury if child seats are installed incorrectly.

Always read and follow the installation instructions and warning information provided by the child seat manufacturer.

 WARNING

There is a risk of injury if a front-facing child seat is on the front passenger seat.

Move the front passenger seat as far back as possible and adjust to its highest position to create the largest possible distance between the child seat and the front passenger front airbag.

Move the backrest to the upright position.

Adjust the seat belt height adjuster to the highest position.

Use only child seats that have been approved by the child seat manufacturer for use on a front passenger seat with front and side airbags.

WARNING

To help avoid injuries caused by inflation of a curtain airbag or side airbag:

Ensure that no children are seated within the airbag deployment zones ⇒ Airbag system .

Do not place any objects in the side airbag deployment zones.

Securing systems

 First read and observe the introductory information and safety warnings ⇒  Introduction

Different countries use different securing systems for safely fitting child seats in the vehicle.

Overview of securing systems

ISOFIX: ISOFIX is a standardised securing system for fitting child seats in the vehicle quickly and safely. The ISOFIX attachment system creates a rigid connection between the child seat and the vehicle body.

Compatible child seats have two rigid attachment arms that engage in ISOFIX attachment points at the bottom of the backrest (on the outer rear seats). The ISOFIX securing system as described here is specific to Europe ⇒ Securing a child seat with ISOFIX . An upper strap (top tether) and/or support foot may sometimes have to be used in addition to the ISOFIX anchor points described above.

Three-point automatic seat belt. It is preferable to secure child seats using the ISOFIX system, if available, rather than with a three-point automatic seat belt ⇒ Securing child seats with a seat belt .

Additional securing points:

Recommended child seat securing systems

Volkswagen recommends that child seats are secured as follows:

Infant carrier or rear-facing child seat: ISOFIX and support foot.

Front-facing child seat: ISOFIX and top tether and possibly also support foot.

WARNING

Incorrect use of the support foot can cause severe or fatal injuries.

Ensure that the support foot is always correctly and safely installed.

Securing a child seat with ISOFIX



Fig. 46 Markings identifying the ISOFIX anchor points for child seats.



Fig. 47 Illustration: fitting an ISOFIX child seat with attachment arms.



First read and observe the introductory information and safety warnings ⇒ Introduction

Overview of child seat installation with ISOFIX and i-Size

The table below shows the options for securing ISOFIX or i-Size child seats to the ISOFIX anchor points at the various possible seats in the vehicle.

Group	Size class	Front passenger seat	Outer rear seats	Centre rear seat
Group 0: up to 10 kg	E	X	IL-SU	X
Group 0+: up to 13 kg	E	X	IL-SU	X
	D	X		X
	C	X		X
Group 1: 9 to 18 kg	D	X	IL-SU, IUF	X

Group	Size class	Front passenger seat	Outer rear seats	Centre rear seat
	C	X		X
	B	X		X
	B1	X		X
	A	X		X
Group 2: 15 to 25 kg	–	X	IL-SU	X
Group 3: 22 to 36 kg	–	X	IL-SU	X
i-Size child restraint system	–	X	i-U	X

Size class: the size class shown corresponds to the permissible weight range of the child using the seat. The size class is indicated on the ECE approval label for child seats with universal or semi-universal approval. The size class label is affixed to the child seat.

X: seat not suitable for securing an ISOFIX or i-Size child seat in this group.

IL-SU: seat suitable for installing an ISOFIX child seat with "semi-universal" approval. Refer to the vehicle list supplied by the child seat manufacturer.

IUF: seat suitable for installing an ISOFIX child seat with "universal" approval.

i-U: seat suitable for installing a front-facing or rear-facing i-Size child seat with "universal" approval.

i-UF: seat suitable for installing a front-facing i-Size child seat with "universal" approval.

Installing child seats with ISOFIX/i-Size

Observe and follow the instructions ⇒ Fitting and using child seats .

Pull on both sides of the child seat to check whether the seat has clicked properly into place.

Securing child seats with a seat belt



First read and observe the introductory information and safety warnings ⇒  Introduction

If you want to fit a child seat from the "universal" (u) approval category in your vehicle, you must first ensure that it is approved for the seat position in question. Important information is given on the orange ECE approval label on the child seat. Installation options are shown in the table below.

Securing a child seat with a seat belt

Observe and follow the instructions ⇒ Fitting and using child seats .

Fasten the seat belt and guide it through the child seat as described in the child seat manufacturer's instructions.

Ensure that the seat belt is not twisted.

Insert the latch plate into the buckle for the appropriate seat and push it down until it audibly locks into place.

In an emergency

Making you and your vehicle safe

Observe any legislation concerning the safety of a broken-down vehicle. For example, many countries stipulate that you have to switch on the hazard warning lights and wear a high-visibility waistcoat ⇒ Equipment for an emergency .

Checklist

To ensure your own safety and that of your passengers, carry out the following actions in the specified order ⇒ ⚠ :



Stop the vehicle at a safe distance away from moving traffic and on a suitable surface .



Switch on the hazard warning lights using the button Centre console.



Switch on the electronic parking brake Electronic parking brake.



Select the neutral position Manual gearbox: selecting a gear or move the selector lever to P position DSG® dual clutch gearbox.



Stop the engine and remove the key from the ignition Starting and stopping the engine.



Ensure that all occupants exit the vehicle and go straight to a safe place away from moving traffic, e.g. behind the safety barrier. Heed the country-specific regulations concerning high-visibility waistcoats.



Take all vehicle keys with you when you leave the vehicle.



Set up the warning triangle to draw the attention of other road users to your vehicle.



Allow the engine to cool down and, if necessary, seek expert assistance.

When the hazard warning lights are switched on, for example if you are being towed, you can still indicate a change in direction or lane change by operating the turn signal. The hazard warning lights will be interrupted temporarily.

Switch on the hazard warning lights, e.g. in the following situations:

When traffic ahead suddenly starts moving more slowly or you reach the tail end of a traffic jam to warn vehicles behind you.

There is an emergency situation.

The vehicle has broken down.

When tow-starting or towing.

Always follow local regulations on the use of the hazard warning lights.

If the hazard warning lights are not working, you must use an alternative method of drawing attention to the broken-down vehicle. This method must comply with traffic legislation.

 WARNING

Any broken-down vehicle poses a high accident risk for the vehicle occupants and for other road users.

Stop the vehicle as soon as possible and when safe to do so.

Park the vehicle at a safe distance from moving traffic.

Switch on the hazard warning lights.

Never leave other persons alone in the vehicle, particularly children or people requiring assistance. This applies in particular when the doors are locked. People locked in the vehicle may be subjected to very high or very low temperatures.

 WARNING

Ignoring any of the items on this important safety checklist can lead to accidents and severe injuries.

Always follow the instructions in the checklist and observe the general safety procedures.

 WARNING

The components of the exhaust system become very hot. This can cause fires and serious injuries.

Park the vehicle so that no part of the exhaust system can come into contact with any inflammable material underneath the vehicle, e.g. dry grass, fuel.

⚠ NOTICE

When pushing the vehicle by hand, do not press on the tail light clusters, the rear spoiler or large panels. This could damage the vehicle and the rear spoiler could become detached.



The 12-volt vehicle battery will discharge if the hazard warning lights are left on over a long period of time – even when the ignition is switched off.



Depending on the vehicle equipment, the brake lights flash rapidly if you brake sharply or initiate full braking at a speed of more than 80 km/h (50 mph). This is a particularly effective way of attracting the attention of vehicles behind you. If you then continue to brake, the hazard warning lights will be switched on automatically at speeds under approximately 10 km/h (6 mph). Once you start to accelerate, the hazard warning lights will switch off again automatically.

Equipment for an emergency

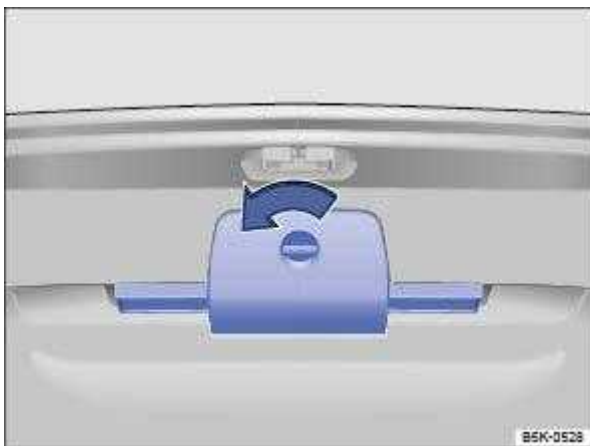

Fig. 48 In the boot lid: holder for the warning triangle.

First-aid kit

Depending on the equipment, the first-aid kit may be located in a stowage compartment or holder in the luggage compartment, under the luggage compartment floor or in the vehicle interior.

The first-aid kit must comply with legal requirements. Please note the expiry date of the contents.

After use, replace any of the contents as necessary and then stow the first-aid kit away again safely.

Warning triangle

Depending on the equipment, the warning triangle may be located in the boot lid. When the boot lid is open, turn the lock of the holder ⇒ Fig. 48 by 90° anticlockwise in the direction of the arrow, open the holder and remove the warning triangle.

The warning triangle must comply with legal requirements.

After use, return the warning triangle to its holder and lock it into place.

High-visibility waistcoat

Depending on the vehicle equipment, the high-visibility waistcoat may be located in a stowage compartment in the front door trim or in the stowage compartment on the front passenger side
⇒ Driver door , ⇒ Front passenger side .

The high-visibility waistcoat must comply with legal requirements.

Fire extinguisher

Depending on the equipment, a fire extinguisher may be located in a holder in the footwell under the front passenger seat.

The fire extinguisher must meet legal requirements, be ready for use at all times and be checked on a regular basis (see inspection seal on the fire extinguisher).

WARNING

In the event of a sudden driving or braking manoeuvre or accident, loose objects could be flung through the vehicle and cause severe injuries.

Always secure the first-aid kit, warning triangle and fire extinguisher safely in the holders in the vehicle.

Stow the high-visibility waistcoat in the stowage compartments so that it can be easily accessed.

Information call, breakdown call and emergency call service

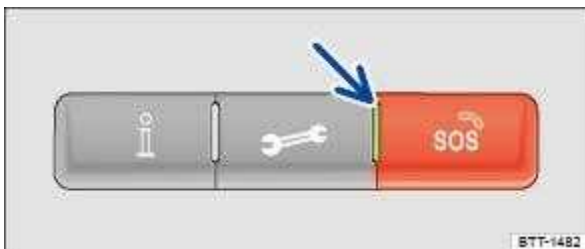





Fig. 49 In the roof console: control for voice services.

With some equipment levels, a control may be installed in the roof console. Pressing the buttons ,  and  ⇒ Fig. 49 enables you to access the following voice services: information call, breakdown call and emergency call service.

The required connection is established by a factory-fitted control unit. A connection to a telephone call centre will be established when you initiate one of the voice services.

Indicator lamp

The control is equipped with an indicator lamp ⇒ Fig. 49 (arrow). This displays the following statuses:

Off: all voice services are deactivated.

Flashing red for approx. 20 seconds after the ignition is switched on: at least one voice service is disabled.

Lit up red: system error. Voice service availability is restricted. Volkswagen recommends consulting a specialist workshop.

Lit up green: voice services are available. System is OK.

Flashing green: active connection to a voice service.

Information call

The information call enables you to call the Volkswagen AG hotline.

The information call function is available only in some sales regions.

The telephone call centre communicates in the language registered for the vehicle in Car-Net.

Breakdown call

The breakdown call allows you to seek professional assistance should your vehicle break down.

Some vehicle data, e.g. the current location, are transmitted parallel to the voice call.

The telephone call centre communicates in the language registered for the vehicle in Car-Net.

SOS Emergency call service

If an emergency call is placed manually, or automatically after an accident where an airbag was triggered, data relevant for the emergency call, e.g. the current vehicle location, will be transmitted automatically ⇒ Customer information .

The telephone call centre communicates in the language set up in the vehicle's Infotainment system. English is used if this language is not available at the location of the emergency.

Back-up to 112 emergency number

In some cases, the emergency call service may be restricted or unavailable so the general emergency call number 112 will be used to conduct an emergency call. In this case, only a voice-based connection is established. No data will be transmitted, e.g. regarding the vehicle or its location.

The following circumstances may restrict access to the emergency call service and lead to the call being forwarded to the 112 emergency number:

Your current emergency call location is in an area with no or insufficient mobile communications and GPS reception. This can also include tunnels, streets with tall buildings, garages, underpasses, mountains and valleys.

You are in an area with sufficient mobile communications and GPS reception but the telecommunications provider's mobile network is not available.

The emergency call service is prohibited by law in some countries.

There is no valid licence for using the emergency call service.

The components in the vehicle required for the emergency call service are damaged or do not have a sufficient power supply.



Please also observe the other information on Volkswagen Car-Net ⇒ Mobile online services .

Opening and closing

Vehicle key

Functions of the vehicle key

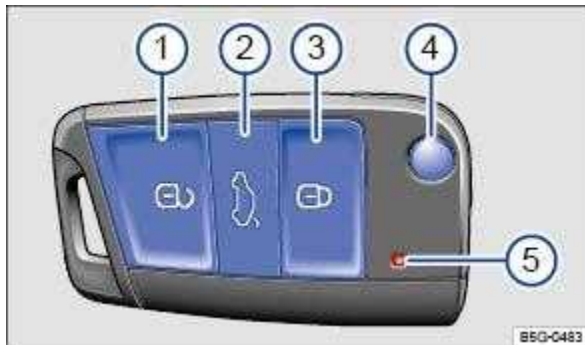



Fig. 50 Vehicle key.



Key to ⇒ Fig. 50 :

- ① Central locking button: unlock the vehicle.
- ② Unlock the boot lid separately.
- ③ Central locking button: lock the vehicle.
- ④ Fold the key bit in and out.
- ⑤ Indicator lamp: flashes when button is pressed.

Unlocking or locking the vehicle from outside

To unlock: press the  button.

To lock: press the  button.

Press the  or  button ⇒ Opening and closing the boot lid . The boot lid is unlocked.

Unlocking: all turn signals flash twice.

Locking: all turn signals flash once.

 **WARNING**

Improper or unsupervised use of the vehicle keys can cause accidents or serious injuries.

Always take all vehicle keys with you every time you leave the vehicle. Otherwise, children or unauthorised persons could lock the doors and the boot lid, start the engine or switch on the ignition and operate electrical equipment, such as the electric windows.

Never leave children or people requiring assistance alone in the vehicle. They could become trapped in the vehicle in an emergency and may not be able to get themselves to safety. For example, locked vehicles may be subjected to very high or very low temperatures depending on the season. This can cause serious injuries and illness or fatalities, especially in the case of small children.

Never switch off the ignition while the vehicle is in motion. The steering column lock or steering lock mechanism may be activated and you will no longer be able to steer the vehicle.

 NOTICE

Every electric vehicle key contains electronic components. Protect the key from damage, moisture and excessive vibration.

Replacing the button cell

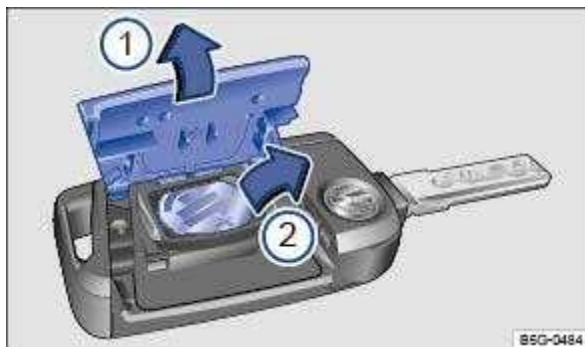



Fig. 51 Vehicle key: replacing the button cell.



Key to ⇒ Fig. 51 :

 Cover.

 Button cell.

Volkswagen recommends having the button cell changed at a Volkswagen dealership or by a qualified workshop ⇒  .

Fold out the key bit.

Lever off the cover ⇒ Fig. 51  ⇒  .

Lever the button cell out of the battery compartment ⇒ Fig. 51  .

Press the new button cell into the battery compartment ⇒  .

Press the cover onto the housing ⇒ Fig. 51  .

 DANGER

Swallowing batteries with a diameter of 20 mm or other button cells can result in serious or even fatal injuries within a very short period of time.

Always keep the vehicle key, key ring with batteries, spare batteries, button cells and other batteries that are larger than 20 mm out of the reach of children.

Call for medical help immediately you suspect that someone has swallowed a battery.

NOTICE

The vehicle key can be damaged if the button cell is not changed properly.

Unsuitable batteries can damage the vehicle key. Replace discharged batteries only with new batteries of the same voltage rating, size and specification.

Make sure the polarity is correct when inserting the battery.



Dispose of discharged batteries in accordance with environmental regulations.

Synchronising the vehicle key

If you cannot lock or unlock the vehicle with the vehicle key, synchronise the vehicle key or replace the button cell ⇒ Replacing the button cell .

Fold out the key bit.

Remove the cap on the driver door handle ⇒ Opening and closing the driver door manually .

Stand beside the vehicle.

Press the  button on the vehicle key.

Unlock the vehicle using the key bit.

Fit the cap ⇒ Opening and closing the driver door manually .

The synchronisation process is complete.

Troubleshooting

Vehicle cannot be locked or unlocked

The remote control is subject to interference caused by obstacles, adverse weather conditions or other transmitters operating in the same frequency range in the vicinity of the vehicle, e.g. mobile devices.

OR: the central locking switches off briefly to protect it from overloading.

Close the driver door.

OR: synchronise the vehicle key ⇒ Synchronising the vehicle key .

Indicator lamp does not flash

If the indicator lamp in the vehicle key does not flash when a button is pressed, the button cell in the vehicle key must be changed ⇒ Replacing the button cell .

Keyless locking and starting system Keyless Access

Introduction

This chapter contains information on the following subjects:

⇒ Unlocking or locking the vehicle with

⇒ Troubleshooting

The Keyless Access locking and starting system enables the vehicle to be locked and unlocked without active use of the key. For this purpose, a valid vehicle key must be within the vehicle's range.

Unlocking or locking the vehicle with Keyless Access

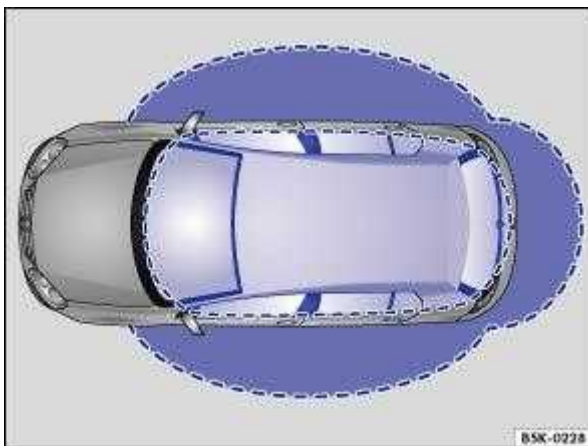

Fig. 52 Keyless Access: operating ranges.

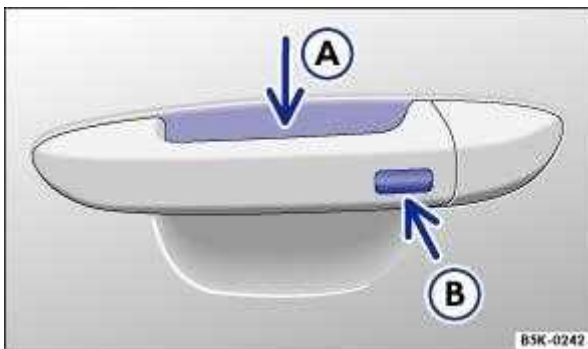

Fig. 53 In the door handle: sensors.

 First read and observe the introductory information and safety warnings ⇒  Introduction

Unlocking and locking the vehicle

Touch the sensor ⇒ Fig. 53 **A** on the inside of the driver or front passenger door handle.

Switch off the ignition.

Close driver or front passenger door.

Touch the sensor ⇒ Fig. 53 **B** on the outside of the driver or front passenger door handle.

Vehicle unlocking is confirmed by all the turn signals flashing twice and locking by the turn signals flashing once.

Locking and unlocking the boot lid

When the vehicle is locked, the boot lid will be unlocked automatically if you open it when a vehicle key is located within the operating range of the boot lid ⇒ Fig. 52 .

The boot lid is locked automatically after it is closed.

If the vehicle is completely unlocked, the boot lid will not lock automatically when closed.

Temporarily deactivating Keyless Access

Keyless Access can be deactivated temporarily as described below so that the vehicle cannot be unlocked and started due to misuse by unauthorised third parties.

Lock the vehicle with the  button in the vehicle key.

In addition, touch the sensor on the outside of the door handle ⇒ Fig. 53  once within five seconds. Do not reach into the door handle.

Keyless Access is temporarily deactivated.

Check deactivation by waiting for at least ten seconds and then pull the door handle again. It should not be possible to open the door.

When the vehicle is next unlocked, it can be unlocked only using the vehicle key. The Keyless Access locking and starting system is reactivated the next time the vehicle is unlocked.

Operating the convenience functions

All electric windows and the glass roof can be closed automatically.

Keep a finger on the sensor ⇒ Fig. 53  of the driver or front passenger door handle for a few seconds until the windows and glass roof are closed.

The sensor functions can be set in the Vehicle settings menu in the Infotainment system ⇒ Infotainment system controls and displays .



The unlocking function is deactivated for a few seconds so that you can check that the vehicle has been locked successfully.



If the message Keyless Access system faulty appears on the instrument cluster display, there may be a malfunction in the Keyless Access system. Go to a qualified workshop.



If there is no vehicle key in the vehicle or if it is not detected, a message will be shown on the instrument cluster display. This may occur if the vehicle key is subject to interference by another

radio signal or is covered by another item, e.g. an aluminium case ⇒ Starting and stopping the engine .



If the vehicle has a DSG® dual clutch gearbox, it can be locked only if the selector lever is in position P.



The entire vehicle will be unlocked if the sensor is touched twice, even if a single door has already been unlocked.

Troubleshooting



First read and observe the introductory information and safety warnings ⇒ ⚠ Introduction

Keyless Access does not work

The function of the sensors may be restricted if they become very dirty.

Clean the sensors.

All turn signals flash four times

The vehicle key used last is still in the vehicle.

Doors and central locking button



Introduction

This chapter contains information on the following subjects:

- ⇒ Indicator lamp in the driver door
- ⇒ Automatic locking and unlocking
- ⇒ Central locking button
- ⇒ Opening and closing the driver door manually
- ⇒ Manually closing the front passenger door and rear doors
- ⇒ Childproof lock
- ⇒ SAFELOCK
- ⇒ Troubleshooting

If the vehicle key or central locking fails, the doors can be locked manually and, in some cases, also unlocked manually.

The central locking system enables you to centrally lock and unlock all the doors, the boot lid and the tank flap of the vehicle.

The vehicle can be locked only if the ignition has been switched off or the driver has switched off the engine before leaving the vehicle.

A symbol in the instrument cluster display ⇒ Displays indicates if one or more doors are not closed properly.  Do not drive on! Open the appropriate door and then close it again.

This symbol is also visible when the ignition is switched off and will go out a few seconds after the vehicle has been locked when all doors are closed.

 **WARNING**

A door which is not closed properly could open suddenly while the vehicle is in motion. This could lead to serious injuries.

Stop as soon as possible and close the door.

Make sure that the door is closed properly and that the lock has engaged. The closed door must be flush with the surrounding body panels.

Doors should be opened or closed only when you are sure that nobody is in their path.

 **WARNING**

Any door being held open by the door arrester could close unexpectedly in strong winds or if the vehicle is on a slope. This could lead to injuries.

Always hold doors by the handle when opening and closing doors.

 **WARNING**

The opening and closing paths of the doors and boot lid are potential danger areas where injury can occur.

The doors and boot lid should therefore be opened or closed only when you are sure that nobody is in their path.

 **WARNING**

Careless locking of the doors can cause serious injuries.

If the vehicle is locked from the outside, the doors and electric windows cannot be opened from the inside.

The central locking system locks all doors. Locking the vehicle from the inside can prevent the doors from being opened unintentionally and unauthorised persons from entering the vehicle. However, locked doors can delay assistance to passengers inside the vehicle in the event of an accident or emergency.

Never leave children or people requiring assistance alone in the vehicle. All doors can be locked from the inside using the central locking button. This may mean that people lock themselves in the vehicle. People locked in the vehicle may be subjected to very high or very low temperatures.

Temperatures inside a locked vehicle may become extremely hot or cold, depending on the season. This can cause serious injuries and illness or fatalities, especially in the case of small children.

Never leave anyone inside a locked vehicle. People in the vehicle could become trapped in an emergency and will not be able to get themselves to safety.

NOTICE

When carrying out manual opening or closing, remove parts carefully and install them again correctly in order to avoid damage to the vehicle.

Indicator lamp in the driver door



First read and observe the introductory information and safety warnings ⇒  Introduction

The central locking indicator lamp is located in the driver door ⇒ Vehicle overviews .

Vehicle is locked: a red LED flashes for approximately two seconds, firstly at short intervals and then more slowly. The indicator lamp does not flash if the vehicle was locked with the central locking button in the driver door ⇒ Central locking button .

Automatic locking and unlocking



First read and observe the introductory information and safety warnings ⇒  Introduction

Settings for central locking can be made in the Vehicle settings menu in the Infotainment system ⇒ Infotainment system controls and displays .

Automatic locking (Auto Lock)

The vehicle can lock itself automatically at speeds above approximately 15 km/h (9 mph). The  indicator lamp in the central locking button will light up yellow when the vehicle is locked.

Automatic unlocking (Auto Unlock)

If one of the following conditions applies, all doors and the boot lid will be automatically unlocked:

The vehicle is at a standstill and the vehicle key has been removed.

In vehicles with DSG® dual clutch gearbox: the selector lever is in position P and the ignition has been switched off.

OR: the vehicle is stationary and the  button has been pressed.

OR: the door release lever has been operated.

OR: in an accident where the airbags have been triggered ⇒ Troubleshooting .

Automatic unlocking provides access to the vehicle if assistance is required.



Depending on the settings made for central locking in the Infotainment system, it may be the case that all of the doors and the boot lid are unlocked only when the  button has been pressed twice.

Central locking button



Fig. 54 In the driver door: central locking button.



Fig. 55 In the driver door: release for the boot lid.



First read and observe the introductory information and safety warnings ⇒  Introduction

Key to ⇒ Fig. 54 and ⇒ Fig. 55 :

Unlock the vehicle.

Lock the vehicle.

Unlock the boot lid.

If the  button in the driver door is pressed, only the boot lid opens. All doors remain locked.

The central locking button functions with the ignition switched on or off only when all doors are closed.

If the vehicle has been locked from outside with the vehicle key, the central locking buttons do not work.

Please note the following when using the central locking button to lock the vehicle from the inside:

The indicator lamp  in the button lights up yellow when all doors are closed and locked.

The anti-theft alarm will not be activated ⇒ Anti-theft alarm .

The doors can be opened from the inside by pulling the door release handle. The indicator lamp  in the button goes out. The unopened doors and boot lid remain locked and cannot be opened from the outside.

If the driver door is open, it will not be locked.

Opening and closing the driver door manually

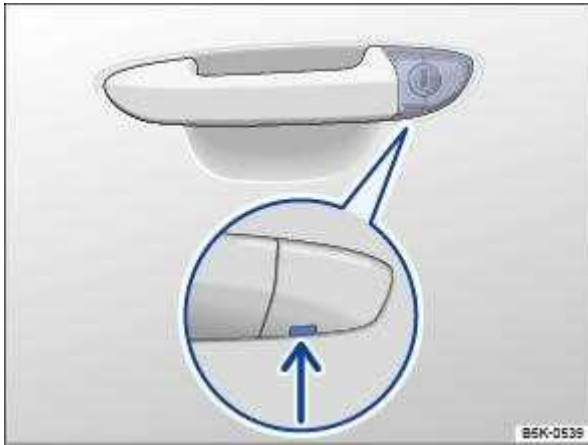

Fig. 56 Driver door handle: concealed lock cylinder.

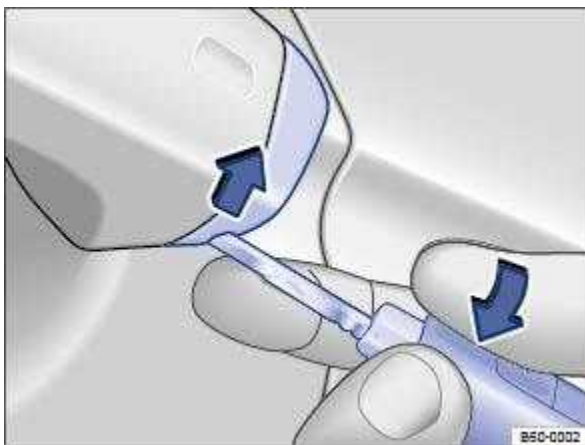

Fig. 57 Driver door handle: lever off cap.



First read and observe the introductory information and safety warnings ⇒  Introduction

All doors are normally locked in the case of manual locking. With manual unlocking, only the driver door is unlocked. Observe information on the anti-theft alarm ⇒ Anti-theft alarm .

Pull on the door release lever until the cap is removed.

Position the key bit at the notch in the driver door handle from below.

Hold your index finger under the key bit.

Lever off the cap with the vehicle key in the direction of the arrow ⇒ Fig. 57 .

Insert the key bit into the lock cylinder and lock or unlock the vehicle.

Pull the door release lever and fit the cap again.

Keyless Access ⇒ Unlocking or locking the vehicle with Keyless Access is not activated if the vehicle was locked manually.

Things to note when unlocking manually

The alarm is triggered when the driver door is opened ⇒ Anti-theft alarm .

After unlocking, an emergency start must be carried out ⇒ Starting and stopping the engine .

Switch on the ignition to switch off the alarm.

The electronic immobiliser recognises a valid vehicle key.



The anti-theft alarm is not activated when the vehicle is locked manually using the key bit ⇒ Anti-theft alarm .

Manually closing the front passenger door and rear doors

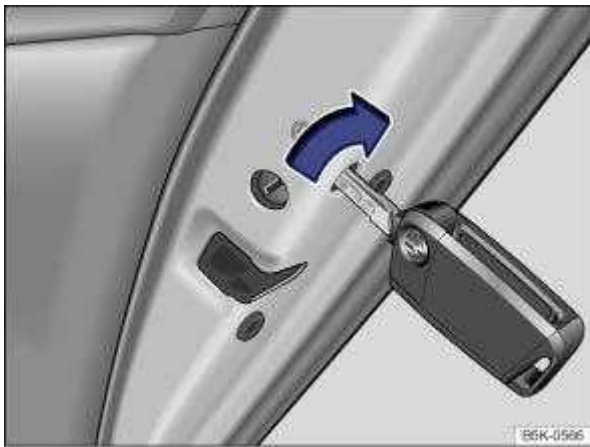

Fig. 58 In the front edge of the rear right-hand door: manually locking the vehicle with the vehicle key.



First read and observe the introductory information and safety warnings ⇒ ⚠ Introduction

The front passenger door and the rear doors can be locked manually. The anti-theft alarm is not activated in this case ⇒ Anti-theft alarm .

Open the door.

Remove the rubber seal  in the front edge of the door.

Insert the key bit into the slot and turn ⇒ Fig. 58 .

Reattach the rubber seal.

Check that the door is locked.

The vehicle should be checked by a qualified workshop as soon as possible.

A door that has been locked manually will be unlocked again if the vehicle is unlocked or the door in question is opened from the inside.



The doors can be unlocked and opened from inside by pulling the door release handle.

Childproof lock

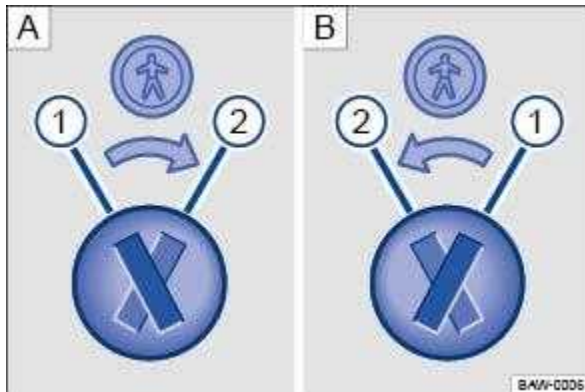

Fig. 59 Childproof lock: rear left door, rear right door.



First read and observe the introductory information and safety warnings ⇒ ⚠ Introduction

Key to ⇒ Fig. 59 :

- ① Childproof lock is switched off.
- ② Childproof lock is switched on.

The childproof lock prevents the rear doors being opened from the inside.

When the childproof lock is activated, the door can only be opened from the outside.

Switching the childproof lock on and off

Unlock the vehicle and open the appropriate rear door.

Move the slot to the corresponding position.

⚠ WARNING

The door cannot be opened from the inside when the childproof lock is activated.

Never leave children or people requiring assistance alone in the vehicle when the doors are locked. This may mean that these people lock themselves in the vehicle. They could become trapped in the vehicle in an emergency and may not be able to get themselves to safety. People locked in the vehicle may be subjected to very high or very low temperatures.

Temperatures inside a locked vehicle may become extremely hot or cold, depending on the season. This can cause serious injuries and illness or fatalities, especially in the case of small children.

SAFELOCK



First read and observe the introductory information and safety warnings ⇒ ⚠ Introduction

With some equipment levels, the vehicle may have a SAFELOCK mechanism.

SAFELOCK deactivates the door release levers if the vehicle has been locked. This makes it more difficult to break into the vehicle. The doors can no longer be opened from the inside ⇒ ⚠.

Press the  button on the vehicle key once.

Press the  button on the vehicle key twice in quick succession.

Vehicles with the Keyless Access locking and starting system: touch the sensor on the outside of the door handle twice ⇒ Unlocking or locking the vehicle with Keyless Access .

OR: press the central locking button  in the driver door once ⇒ Central locking button .

There may be an indication of the activated SAFELOCK in the display of the instrument cluster (SAFELOCK).

Deactivating SAFELOCK

Switch on the ignition.

OR: deactivate interior monitoring and the anti-tow alarm ⇒ Temporarily switching off the interior monitoring system and anti-tow alarm .

Before locking the vehicle, temporarily deactivate the interior monitoring and the anti-tow alarm in the Vehicle Settings menu in the Infotainment system ⇒ Infotainment system controls and displays .

The following applies when SAFELOCK is deactivated:

The interior monitoring and the anti-tow alarm are activated and deactivated in the Vehicle settings menu in the Infotainment system ⇒ Infotainment system controls and displays .

WARNING

Careless or unsupervised use of SAFELOCK can cause serious injuries.

Never leave other persons in the vehicle if the vehicle has been locked using the vehicle key. The doors can no longer be opened from the inside once SAFELOCK is activated.



If you unlock the driver door mechanically using the vehicle key, only the driver door is unlocked, and not the whole vehicle. The doors are released (but not unlocked) and the central locking button is activated only when the ignition is switched on.

Troubleshooting



First read and observe the introductory information and safety warnings ⇒ ⚠ Introduction

Indicator lamp lights up continuously

The red LED in the vehicle door flashes at short intervals and then lights up continuously.

There is a fault in the locking system.

Go to a qualified workshop. Volkswagen recommends using a Volkswagen dealership for this purpose.

Turn signals do not flash

If the turn signals do not flash as confirmation when the vehicle is locked:

At least one of the doors or the boot lid is not closed.

OR: convenience closing is in progress and not all windows and the glass roof have been closed.

Vehicle locks itself automatically

The vehicle will lock itself again automatically after approx. 45 seconds if one of the following conditions applies:

The vehicle has been unlocked but not opened.

The ignition has not been switched on.

The boot lid has not been opened.

The vehicle has been unlocked using the lock cylinder.

The vehicle has been locked using the central locking button in the vehicle interior.

Response when locking the vehicle with a second vehicle key

Keyless Access: the vehicle key located inside the vehicle will be blocked from starting the engine if the vehicle has been locked from the outside using a second vehicle key. Press the  button on the vehicle key in the vehicle interior to enable it to start the engine ⇒ Starting and stopping the engine .

Locking the vehicle after airbags have been triggered

The entire vehicle is unlocked if the airbags are activated in an accident. Depending on the extent of the damage, the vehicle can be locked as follows after an accident:

Switch the ignition off and then back on again.

Automatic deactivation of the sensors

The vehicle is not unlocked or locked for an extended period.

A sensor has been triggered an excessive number of times.

Reactivating the sensors:

Unlock the vehicle with the  button in the vehicle key.



Please note that the sensors in the door handles can be activated by a powerful jet of water or steam if a valid vehicle key is simultaneously within the operating range. If at least one window is open and sensor surfaces on the door handles are continuously activated, all windows will close. All windows could open if the jet of water or steam is moved away from the door handle sensors briefly and then moved back again ⇒ .



It may not be possible to lock or unlock the vehicle using the Keyless Access if the 12-volt vehicle battery or button cell in the vehicle key is weak or discharged. The vehicle can be locked or unlocked manually ⇒ .



If there is no valid vehicle key in the vehicle or if it is not detected, a corresponding message will be shown on the instrument cluster display. This may occur if the vehicle key is exposed to interference from another radio signal or is covered by another item, e.g. an aluminium case ⇒ Starting and stopping the engine .

Anti-theft alarm

Depending on the vehicle equipment level, the vehicle may have an anti-theft alarm.

The anti-theft alarm is activated automatically when the vehicle is locked using the vehicle key.

The anti-theft alarm outputs acoustic and visual warning signals for up to five minutes.

When does the system trigger an alarm?

If a door is opened.

If the bonnet is opened.

If the boot lid is opened.

If the ignition is switched on with a valid vehicle key. (The alarm may sound briefly.)

If the 12-volt vehicle battery is disconnected.

If there is movement inside the vehicle (in vehicles with interior monitoring) ⇒ Interior monitoring system and anti-tow alarm .

If the vehicle is lifted or towed (vehicles with anti-tow alarm) ⇒ Interior monitoring system and anti-tow alarm .

If the vehicle is transported on a car ferry or by rail (vehicles with anti-tow alarm or interior monitoring) ⇒ Interior monitoring system and anti-tow alarm .

If a trailer that is connected to the anti-theft alarm system is removed ⇒ Trailer towing .

Switching off the alarm

Unlock the vehicle using the unlocking button  on the vehicle key.

OR: switch on the ignition using a valid vehicle key. A short alarm lasting around one second may sound.

On vehicles with Keyless Access: grip the door handle ⇒ Unlocking or locking the vehicle with Keyless Access .



The anti-theft alarm will not function correctly if the 12-volt vehicle battery is weak or discharged.

Interior monitoring system and anti-tow alarm

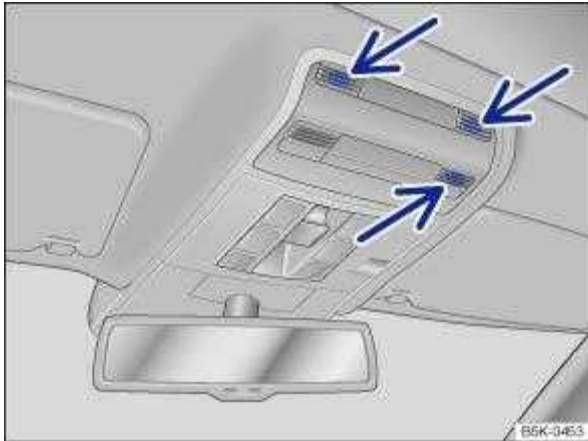

Fig. 60 In the roof console: sensors for the interior monitoring system (arrows).

If movements are detected in the vehicle interior when the vehicle is locked, the interior monitoring system will trigger an alarm ⇒ Fig. 60 .

The anti-tow alarm will be triggered if the vehicle is lifted.

Switching on the interior monitoring system and anti-tow alarm

Close the stowage compartments in the roof console so that the sensors can function.

Close the windows, glass roof, doors and boot lid

Press the locking button once.

The interior monitoring system and anti-tow alarm are activated.

Temporarily switching off the interior monitoring system and anti-tow alarm

The interior monitoring and the anti-tow alarm can be switched off temporarily in the Vehicle settings menu in the Infotainment system ⇒ Infotainment system controls and displays .

To avoid false alarms, deactivate interior monitoring and the anti-tow alarm in the following situations:

If any people or animals are to remain inside the vehicle.

If the vehicle is to be loaded onto another vehicle, transported or towed away.

If the vehicle is to be parked in a car wash or a two-storey garage.

If one or more windows or the glass roof are fully or partly open.

If lightweight items such as loose pieces of paper or items hung from the interior mirror are left in the vehicle.

If there is a mobile phone in the vehicle with the vibration alarm switched on.



Permanent deactivation of interior monitoring and the anti-tow alarm is not possible.



If doors or the boot lid are still open when the anti-theft alarm is activated, only the anti-theft alarm will be activated. Interior monitoring and the anti-tow alarm are not activated until all doors and the boot lid are closed.



SAFELOCK is also deactivated when the interior monitoring and anti-tow alarm are switched off
⇒ SAFELOCK .

Boot lid



Introduction

This chapter contains information on the following subjects:

- ⇒ Opening and closing the boot lid
- ⇒ Opening and closing the boot lid electrically
- ⇒ Unlocking the boot lid manually
- ⇒ Troubleshooting

The boot lid is locked and unlocked at the same time as the doors.



WARNING

Incorrect and unsupervised unlocking, opening or closing of the boot lid can cause accidents and serious injuries.

The boot lid should be opened or closed only when you are sure that nobody is in its path.

Always check that the boot lid is closed properly once it has been closed. The closed boot lid must be flush with the surrounding body panels.

Always keep the boot lid closed while the vehicle is in motion.

Never open the boot lid when loads, e.g. bicycles, are attached to it. The boot lid may close under its own weight due to the additional load. Support the boot lid as necessary or remove the load from the boot lid beforehand.

Close and lock the boot lid and all vehicle doors when the vehicle is not in use. Ensure that no one remains in the vehicle.

Never leave children playing unattended in or around the vehicle, especially when the boot lid is open. Children could climb into the luggage compartment and shut the boot lid, thereby trapping themselves inside. Temperatures inside a locked vehicle may become extremely hot or cold, depending on the season. This can cause serious injuries and illness or fatalities, especially in the case of small children.

 WARNING

Serious injuries could occur if the boot lid is unlocked or opened incorrectly or without due care and attention.

The boot lid may not always be detected as being unlocked if there is a carrier and items attached to it. The boot lid may open suddenly while the vehicle is in motion if it is unlocked.

 WARNING

If heavy snow or heavy items are located on the boot lid, the additional weight could cause the boot lid to close on its own and cause severe injuries.

Never open the boot lid if it is covered by a large amount of snow or a load is attached to it, e.g. on a luggage carrier.

Remove the snow or load before opening the boot lid.

 WARNING

Do not push down the boot lid with your hand on the rear window. The rear window could shatter and cause injuries.

 NOTICE

Never use the opening mechanism to fix or hold a load. This could lead to damage that makes it impossible to close the boot lid.

 NOTICE

Never use the rear window wiper or the rear spoiler to fix or hold a load. This could cause damage which results in the rear window wiper or rear spoiler being torn off.

Opening and closing the boot lid



Fig. 61 In the driver door: release button for the boot lid.

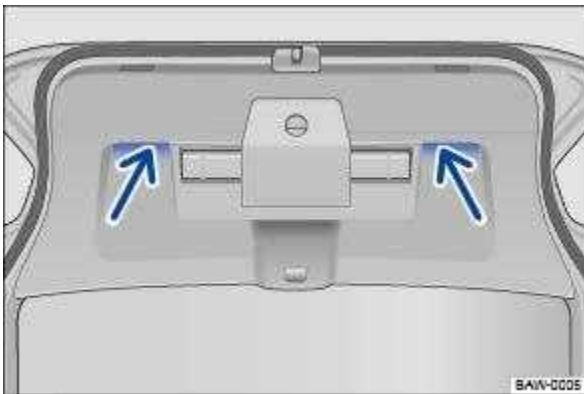

Fig. 62 Open boot lid: handle recesses for closing the boot lid.



First read and observe the introductory information and safety warnings ⇒  Introduction

Opening the boot lid

To unlock the boot lid, press the  or  button on the vehicle key.

Press on the top of the Volkswagen badge and lift up the boot lid.

Closing the boot lid

Pull the boot lid downwards by one of the handle recesses in the interior trim ⇒ Fig. 62 with sufficient momentum so that it engages in the lock ⇒ .

When the doors are locked, the boot lid is locked as well.

The instrument cluster display ⇒ Displays indicates if the boot lid is open or not closed properly.

The boot lid is automatically locked while the vehicle is in motion.

 **WARNING**

Serious injuries could occur if the boot lid is closed incorrectly or without due care and attention.

When closing the boot lid, make sure that there are no hands in the direct path of the boot lid as it moves.



If the boot lid is not opened within a few minutes after unlocking, it automatically locks again.

Opening and closing the boot lid electrically

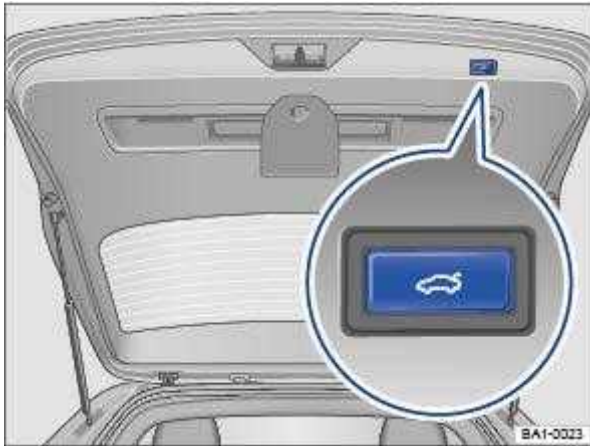



Fig. 63 In the open boot lid: button for electric closing of the boot lid.



First read and observe the introductory information and safety warnings ⇒ Introduction

Depending on the vehicle equipment, the boot lid can be opened and closed electrically.

Opening the boot lid electrically

Briefly press and hold the  button on the vehicle key to unlock the boot lid.

OR: pull the  button in the driver door upwards ⇒ Fig. 61 .

OR: press the top part of the Volkswagen badge.

The boot lid will then open.

Closing the boot lid electrically

Press the button in the open boot lid ⇒ Fig. 63 .

OR: with the ignition switched on, pull the  button in the driver door upwards until the boot lid is closed.

OR: on vehicles with the Keyless Access locking and starting system: briefly press and hold the  button on the vehicle key. The vehicle key must be within the operating range.

OR: press the top part of the Volkswagen badge.

OR: move the boot lid manually in closing direction until the boot lid closes by itself.

The boot lid is closed.

Interrupting the opening or closing procedure

Press one of the  buttons during the opening or closing procedure.

OR: press the top part of the Volkswagen badge during the opening or closing process.

The boot lid can now be moved by hand. You will need to use increased force for this.

Pressing the  button again moves the boot lid back into the starting position.

Signal tones

If the boot lid is opened or closed from the vehicle interior or using the vehicle key, signal tones will sound.

Changing and storing the opening angle

If the area behind or above the vehicle is smaller than the path of the boot lid, the opening angle of the boot lid can be changed.

Stop the opening procedure at the desired open position (at least half open).

In the boot lid, press and hold the  button ⇒ Fig. 63 until the hazard warning lights flash.

The changed opening angle will be stored.

The hazard warning lights flash and an acoustic signal sounds to confirm that the changed opening angle has been stored.

Resetting and storing the opening angle

The opening angle must be reset and stored again in order for the boot lid to open fully again.

Push the opened boot lid up as far as it will go by hand. You will need to use increased force for this.

In the boot lid, press and hold the  button ⇒ Fig. 63 until the hazard warning lights flash.

The opening angle will be reset.

The hazard warning lights flash and an acoustic signal sounds to confirm that the opening angle has been reset.

NOTICE

Before opening or closing the boot lid, please check that there is enough space to open and close it, for example when in a garage.

Unlocking the boot lid manually

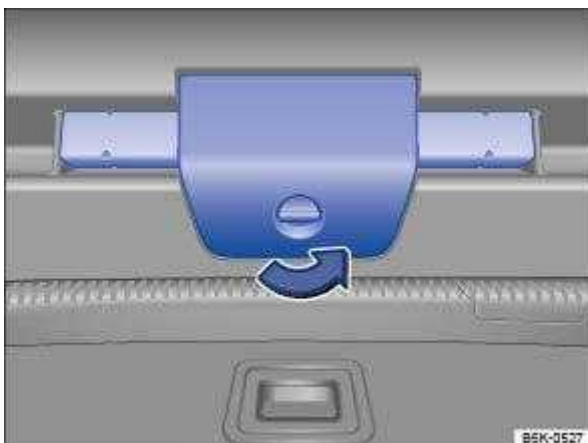

Fig. 64 In the boot lid: open the holder for the warning triangle.

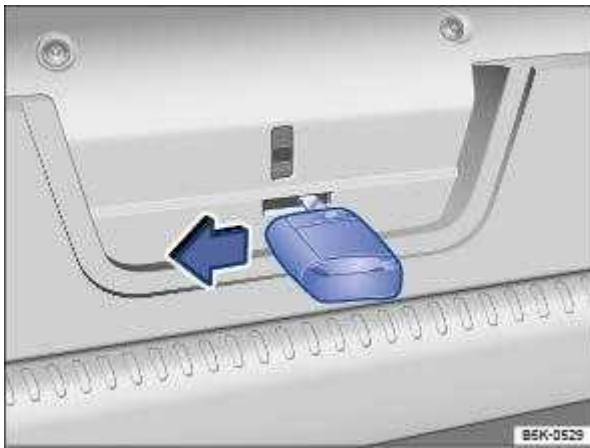

Fig. 65 In the boot lid: manual release mechanism for the boot lid.



First read and observe the introductory information and safety warnings ⇒ ⚠ Introduction

Unlocking the boot lid manually

Turn the lock of the warning triangle holder 90° anticlockwise ⇒ Fig. 64 .

Open the warning triangle holder and remove the warning triangle.

Insert the key bit into the opening in the boot lid ⇒ Fig. 65 and press the release lever in the direction of the arrow.

Troubleshooting



First read and observe the introductory information and safety warnings ⇒ ⚠ Introduction

Boot lid cannot be opened or closed

Check whether the boot lid is blocked by an obstacle. The boot lid can be moved by hand. You will need to use increased force for this.

The drive switches off automatically in order to prevent overheating if the boot lid is operated too frequently in a short space of time. Until the drive has cooled down, the boot lid can be opened and closed by hand using more force than usual.

When you tow a trailer, the electrical boot lid can only be opened and closed on the boot lid ⇒ Trailer towing .

The boot lid must be closed by hand if the 12-volt vehicle battery or fuse is disconnected or faulty.

All turn signals flash four times

The vehicle key used last is still in the vehicle.



Boot lid is stiff

At outside temperatures below freezing point, the opening mechanism cannot always lift the partially opened boot lid automatically. In this case, guide the boot lid further up by hand.

Windows

Opening and closing windows

The buttons are located in the doors ⇒ Vehicle overviews .

 Opening the windows: press the button. Closing the windows: pull the button.  Press to disable the electric window buttons in the rear doors.

The windows can still be opened or closed using the buttons for a short time after the ignition has been switched off, provided the driver door and the front passenger door are not opened.

One-touch opening and closing

The one-touch opening and closing function can be used to fully open and close the windows. The individual buttons do not have to be held to do this.

One-touch closing: pull the button for the appropriate window up briefly into the second position.

One-touch opening: press the button for the appropriate window down briefly into the second position.

Stopping the one-touch function: press or pull the button for the appropriate window again.

Convenience opening and closing

The windows can be opened and closed from outside the vehicle using the vehicle key when the ignition is switched off:

Press and hold the locking or unlocking button on the vehicle key.

In vehicles with keyless locking and starting system Keyless Access: place your finger on the locking sensor in the door handle for a few seconds until the windows are closed ⇒ Unlocking or locking the vehicle with Keyless Access . The vehicle key must be within the operating range.

To interrupt this function, release the locking or unlocking button OR remove your finger from the sensor.

A valid vehicle key must be located within the operating range. All turn signals will flash once as confirmation that all the windows and the glass roof have been closed.

Set the convenience opening settings in the Vehicle settings menu in the Infotainment system ⇒ Infotainment system controls and displays .

WARNING

Careless or unsupervised use of the electric windows can cause serious injuries.

The electric windows should only be opened or closed when you are sure that nobody is in their operating area.

Never leave children or people requiring assistance alone in the vehicle when the vehicle is locked. The windows can no longer be opened in an emergency.

Always take all vehicle keys with you every time you leave the vehicle. The windows can still be opened or closed using the buttons for a short time after the ignition has been switched off, provided the driver door and the front passenger door are not opened.

When transporting children on the rear bench seat, the rear electric windows should always be deactivated using the safety button so that they cannot be opened or closed.

 NOTICE

If windows are open when it starts to rain, water can soak the interior equipment of the vehicle and cause damage to the vehicle.



One-touch opening and closing and the roll-back function will not work if there is a malfunction in the electric windows. Go to a qualified workshop.



Convenience opening and closing only works when one-touch opening and closing is activated for all electric windows.



Some settings can be saved in the user accounts for personalisation and therefore change automatically when the user account is changed ⇒ Personalisation .

Electric window roll-back function

The roll-back function for the electric windows can reduce the risk of injuries when the windows are closing.

If the window is not able to close because it is stiff or because of an obstruction, the window will immediately open again ⇒  .

Check to see why the window has not closed.

Try to close the window again.

If the window closing process is interrupted again, the roll-back function will be disabled for a few seconds.

If the window still cannot close, it will come to a stop at this point. To close the window without the roll-back function, press the button again within a few seconds ⇒  .

 WARNING

Closing the electric windows without the roll-back function can lead to serious injuries.

Always close the window carefully.

Ensure that nobody obstructs the path of the window, especially if a window is being closed when the roll-back function is not active.

The roll-back function does not prevent fingers or other body parts from being pressed against the window frame and being injured.



The roll-back function is also activated if the windows are closed using the vehicle key for convenience closing.

Troubleshooting

One-touch opening and closing does not work

One-touch opening and closing is deactivated if the 12-volt vehicle battery has been disconnected or discharged while the windows were not fully closed. The function must then be reset:

Switch on the ignition.

Close all windows and doors.

Pull up the button for the respective window and hold it in this position for several seconds.

Release the button, then pull it up again and hold it in this position. The one-touch function is now ready for operation again.

The one-touch function can be restored for individual windows or for several windows at the same time.

Closing windows without roll-back function

Attempt to close the window again within a few seconds by holding the button. The roll-back function will be deactivated for a small part of the path of the closing window.

If the closing procedure takes longer than several seconds, the roll-back function will be reactivated. If it is still stiff or obstructed, the window will stop and open again automatically.

Please go to a qualified workshop if the window still cannot be closed.

Glass roof

Opening and closing the glass roof

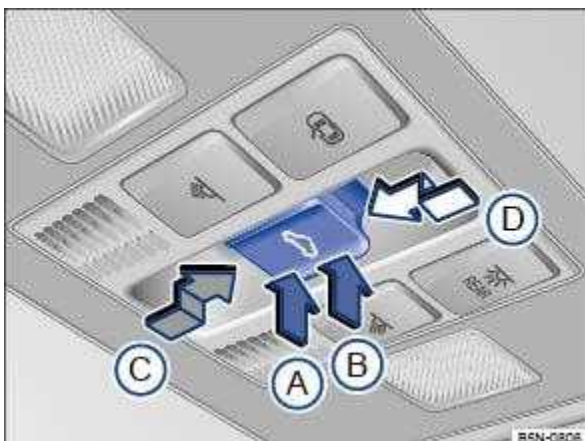



Fig. 66 In the roof: button for the glass roof.

The term glass roof is used as a standard term for the panorama sliding/tilting roof.

The glass roof is a roof opening system featuring two glass elements. The rear glass element is fixed and cannot be opened.

The  button has two positions. First stage: fully or partially tilt, open or close the roof. Second stage: automatically move the roof to the respective limit position. Press the button again to stop the one-touch function.

Tilting the glass roof: push the button \Rightarrow Fig. 66 **B** to the first position. One-touch function: push button **B** to the second position.

Closing the tilted glass roof: push the button **A** to the first position. One-touch function: push button **A** to the second position.

Opening the glass roof: push the button **C** to the first position. One-touch function up to convenience position: push button **C** to the second position.

Closing the glass roof: push the button **D** to the first position. One-touch function: push button **D** to the second position.

Stopping one-stop function of the opening or closing procedure: push button **C** or **D** again.

WARNING

Careless or unsupervised use of the glass roof can cause serious injuries.

Open and close the glass roof only when you are sure that nobody is obstructing the path of the roof.

Always take all vehicle keys with you every time you leave the vehicle.

Never leave children or people requiring assistance alone in the car, particularly if they have access to the vehicle key. Unsupervised use of the vehicle key can lock the vehicle, start the engine, switch on the ignition and operate the glass roof.

The glass roof can still be opened or closed for a short time after the ignition has been switched off, provided that the driver door or front passenger door are not opened.

NOTICE

To avoid damage during cold weather, clear any ice and snow off the vehicle roof before opening or tilting the glass roof.

Always close the glass roof when you leave the vehicle or if it starts to rain. Any rain entering the vehicle when the glass roof is open or tilted could cause significant damage to the electrical system. This can result in further damage to the vehicle.



Remove leaves and other loose items from the glass roof guide rails at regular intervals using a vacuum cleaner, or by hand.



The roll-back function will not work properly if there is a malfunction in the glass roof. Go to a qualified workshop.

Convenience opening or closing of the glass roof

Convenience opening and closing

The glass roof can be opened and closed from outside the vehicle using the vehicle key:

Press and hold the locking or unlocking button on the vehicle key. The glass roof is tilted or closed.

In vehicles with the Keyless Access locking and starting system: place your finger on the locking sensor in the door handle for a few seconds until the glass roof is closed ⇒ Unlocking or locking the vehicle with Keyless Access .

Release the locking or unlocking button to interrupt this function.

The convenience closing function closes all the windows in the doors and the glass roof. All turn signals will flash once as confirmation that all the windows and the glass roof have been closed.

Make settings for operation of the glass roof in the Vehicle settings menu in the Infotainment system ⇒ Infotainment system controls and displays .



Some settings can be saved in the user accounts for personalisation and therefore change automatically when the user account is changed ⇒ Personalisation .

Glass roof roll-back function

The roll-back function reduces the risk of crush injuries ⇒  . If the glass roof is obstructed during the closing process, it will open again immediately.

Check to see why the glass roof has not closed.

Try to close the glass roof again.

If the glass roof still cannot be closed, close it without the roll-back function.

Closing the glass roof without the roll-back function

Press the  button to the second position  until the glass roof has fully closed.

The glass roof will now close without the roll-back function.

Please go to a qualified workshop if the glass roof still cannot be closed.

If you release the switch during the closing procedure, the glass roof will open automatically.

 **WARNING**

Closing the glass roof without the roll-back function can cause serious injuries.

Always close the glass roof carefully.

Ensure that nobody obstructs the path of the glass roof, especially if the roll-back function is not active when it is closed.

The roll-back function does not prevent fingers or other body parts from being pressed against the roof frame and being injured.



The roll-back function is also activated if you use the convenience closing function on the vehicle key to close the windows and the glass roof.

Troubleshooting

Glass roof does not close

The glass roof works only when the ignition is switched on. The glass roof can still be opened or closed for a short time after the ignition has been switched off, provided that the driver door or front passenger door are not opened.

Steering wheel

Adjusting the steering wheel position

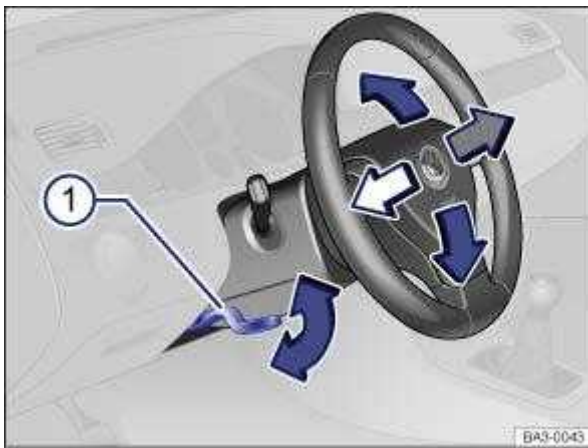

Fig. 67 Below the steering wheel in the steering column trim: lever for mechanical adjustment of the steering wheel position.

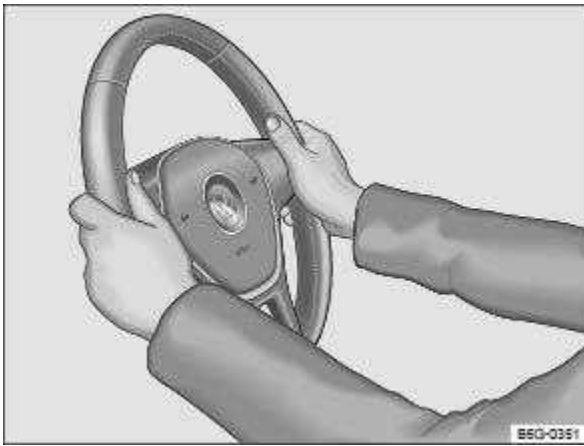

Fig. 68 On the steering wheel: 9 o'clock and 3 o'clock position.

Adjust the steering wheel position before setting off and only when the vehicle is stationary ⇒ ⚠.

Push down the lever ⇒ Fig. 67①.

Adjust the steering wheel so that you can hold it with both hands at its circumference at the 9 o'clock and 3 o'clock positions with your arms slightly bent ⇒ Fig. 68.

Push the lever up firmly until it is flush with the steering column trim ⇒ ⚠.

⚠ WARNING

Incorrect use of the steering column position adjustment and incorrect adjustment of the steering wheel can cause serious or fatal injuries.

After adjusting the steering column, always move lever ⇒ Fig. 67① up so that it engages securely. This prevents the steering column from moving spontaneously while the vehicle is in motion.

Never adjust the steering wheel when the vehicle is in motion. If you determine that a readjustment is necessary when driving, stop the vehicle safely and adjust the steering wheel to the correct position.

The steering wheel must always point towards the chest and not towards the face. This ensures that the driver front airbag provides maximum protection in the event of an accident.

While driving, always keep both hands on the outside of the steering wheel at the 9 o'clock and 3 o'clock positions ⇒ Fig. 68. This reduces the risk of injury if the driver front airbag is triggered.

Never hold the steering wheel at the 12 o'clock position, or in any other manner, e.g. at the hub of the steering wheel. If the driver front airbag is triggered, you could sustain serious injuries to the arms, hands and head.

Seats and head restraints

Front seats

 Introduction

This chapter contains information on the following subjects:

⇒ Mechanically adjusting the front seat

⇒ Folding the front passenger seat backrest forwards

The following section describes the options for adjusting the front seats. Always ensure that you adjust the correct sitting position ⇒ Sitting position .

 **WARNING**

Always adjust the front seats to their correct position before any journey and ensure that all passengers have fastened their seat belts.

Push the front passenger seat as far back as possible.

Adjust the driver seat so that there is at least 25 cm between your breastbone and the hub of the steering wheel. Adjust the driver seat by moving it forwards or backwards so that you are able to press the pedals to the floor with your knees still slightly angled and the distance to the dash panel in the knee area is at least 10 cm. If your build makes it impossible to fulfil this requirement, you must contact a qualified workshop so they can make any necessary modifications.

Never travel with the backrest tilted far back. The further back the backrest is tilted, the greater the risk of injury caused by incorrect seat belt routing or an incorrect sitting position.

Never travel with the backrest tilted far forwards. When a front airbag is triggered, it could force the seat backrest backwards and injure vehicle occupants on the rear seats.

Adopt and maintain the greatest possible distance from the steering wheel and dash panel.

You should always sit upright with your back against the seat backrest with the front seats properly adjusted. Do not position any body part too close to where the airbags are fitted.

The risk of serious injury is increased for passengers on the rear seat if they are not sitting upright because the seat belts are incorrectly positioned.

 **WARNING**

Incorrect adjustment of the seats can cause accidents and serious injuries.

The seats must be adjusted only when the vehicle is stationary, or else the seat could change position unexpectedly while the vehicle is in motion, leading to a loss of control of the vehicle. Furthermore, an incorrect seating position is adopted while adjusting the seat.

Adjust the height and tilt of the seat or move it forwards and backwards only when the area around the seat is clear.

The adjustment range of the seats must not be restricted by any items.

Adjust the tilt angle of the rear seats or move them forwards and backwards only when the area around the seats is clear.

The adjustment and locking areas of the seats must not be soiled.

 **WARNING**

Cigarette lighters left in the vehicle can become damaged or may ignite unnoticed. This can cause serious burns and vehicle damage.

Before adjusting the seats, always make sure that there is no lighter on or near the moveable parts of the seat.

Before closing stowage areas or compartments, always make sure that there is no lighter in the way.

Never stow lighters in stowage areas, compartments or on other surfaces in the vehicle. Cigarette lighters may self-ignite as a result of high surface temperatures, particularly in summer.

 **NOTICE**

Sharp edges can damage the seats.

Do not touch the seats with sharp-edged objects. Sharp-edged objects such as zips, rivets on clothing or belts can damage surfaces. Open Velcro fasteners can also cause damage.

Mechanically adjusting the front seat



Fig. 69 On the left front seat: controls.

 First read and observe the introductory information and safety warnings ⇒  Introduction

The following section contains a description of all possible controls. The number of controls may vary depending on the version of the seat.

The control elements are mirrored for the front right-hand seat.

Adjusting the seat position

Key to ⇒ Fig. 69 :

①

Operate the lever to adjust the lumbar support.

②

Take your weight off the backrest and turn the handwheel to adjust the backrest position.

Front passenger seat: take your weight off the backrest and operate the lever to adjust the backrest position (depending on equipment).

③

Move the lever up or down, several times if necessary, to adjust the seat height.

④

Pull the lever to push the front seat forwards or backwards. The front seat must engage after the lever has been released.

Folding the front passenger seat backrest forwards

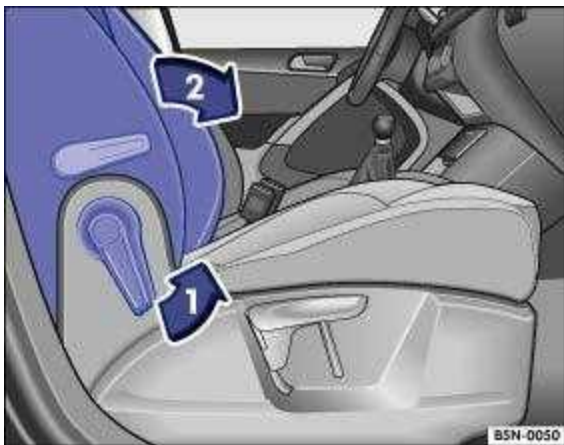

Fig. 70 Front passenger seat: folding backrest forwards.



First read and observe the introductory information and safety warnings ⇒ ⚠ Introduction

The front passenger seat backrest can be folded forwards to a horizontal position.

The front passenger front airbag must be switched off if any items are to be transported on the front passenger seat when folded forwards ⇒ Airbag system .

Folding the front passenger seat backrest forwards

Remove any items from the front passenger seat cushion ⇒ ⚠ .

Lower the front passenger seat down as far as possible.

Push the front passenger seat as far back as possible.

Push the head restraint all the way down.

Release the front passenger seat backrest in the direction of the arrow ⇒ Fig. 70 ① .

Fold the front passenger seat backrest forwards in the direction of the arrow ⇒ Fig. 70② until it is horizontal.

When it is folded down, the front passenger seat backrest must engage securely into place.

Folding back the front passenger seat backrest

When folding back, make sure that there are no items or body parts in the area of the hinges.

To fold back, release the front passenger seat backrest again ⇒ Fig. 70① .

Fold back the front passenger seat backrest so that it is upright.

When it is folded up, the front passenger seat backrest must engage securely into place.

 **WARNING**

Serious injuries could be caused if the front passenger seat backrest is folded forwards and backwards in an uncontrolled way and without taking due care.

Fold the front passenger seat backrest forwards and backwards only when the vehicle is stationary.

When folding the front passenger seat backrest forwards, always make sure that there are no people, animals or objects in its path.

The front airbag must be switched off and the PASSENGER AIR BAG **OFF**  indicator lamp must be lit for as long as the front passenger seat backrest is folded forwards.

When folding forwards and backwards, keep all hands, fingers, feet and other body parts away from the seat hinges and seat release mechanism.

Floor mats or other objects could get caught in the hinges on the front passenger seat backrest. This could cause the front passenger seat backrest to fail to engage securely when it is returned to the upright position.

When being folded back, the front passenger seat backrest must be securely locked in the upright position. If the front passenger seat backrest is not locked properly, it could move suddenly and cause serious injuries.

 **WARNING**

The open seat anchorages and hinges of the folded front passenger seat backrest can cause serious injuries in the event of a sudden braking manoeuvre or accident.

Never transport either adults or children on the front passenger seat if the front passenger seat backrest is folded forwards.

If the front passenger seat backrest is folded forwards, you must use only the rear seat behind the driver seat. This also applies to children in child seats.

Rear seats



Introduction

This chapter contains information on the following subjects:

⇒ Folding the backrests on the rear bench seat forwards and backwards

The following section describes the options for adjusting the rear seats. Always ensure that you adjust the correct sitting position ⇒ Sitting position .



WARNING

Incorrect adjustment of the rear seat can cause accidents and serious injuries.

The rear seat should be adjusted only when the vehicle is stationary as the rear seat could otherwise move unexpectedly while the vehicle is in motion. Furthermore, an incorrect seating position is adopted while adjusting the seat.

Adjust the rear seat only when there is no one in the adjustment area of the rear seats.



WARNING

Cigarette lighters left in the vehicle can become damaged or may ignite unnoticed. This can cause serious burns and vehicle damage.

Before adjusting the seats, always make sure that there is no lighter on or near the moveable parts of the seat.

Before closing stowage areas or compartments, always make sure that there is no lighter in the way.

Never stow lighters in stowage areas, compartments or on other surfaces in the vehicle. Cigarette lighters may self-ignite as a result of high surface temperatures, particularly in summer.



WARNING

In order to reduce the risk of injury while the vehicle is in motion, the centre armrest must always be folded up and the stowage compartment must be closed.

The middle seat on the rear bench seat must never be used when the centre armrest is folded down – neither by adults nor children. An incorrect sitting position can cause serious injuries.

Never transport an adult or child on the centre armrest.

Close the stowage compartment only when there is no one in its closing path.



NOTICE

Items in the luggage compartment could cause damage when pushing the rear seat forwards or backwards.

When the rear seat is moved forwards, objects can get into the space between the seat and luggage compartment floor. Remove any items or objects from this space before pushing the rear seat back.

⚠ NOTICE

Sharp edges can damage the seats.

Do not touch the seats with sharp-edged objects. Sharp-edged objects such as zips, rivets on clothing or belts can damage surfaces. Open Velcro fasteners can also cause damage.

Folding the backrests on the rear bench seat forwards and backwards

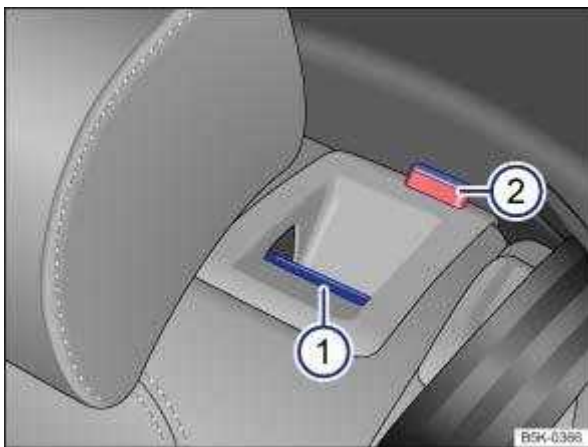

Fig. 71 In the rear seat backrest: release button.



First read and observe the introductory information and safety warnings ⇒ ⚠ Introduction

The rear seat backrest is split. Each part of the rear seat backrest can be folded down individually to increase the size of the luggage compartment.

Folding the rear seat backrest forwards

Push the head restraint all the way down.

Pull the release button ⇒ Fig. 71 ① forwards and fold the rear seat backrest forwards at the same time.

The respective section of the rear seat backrest is unlocked when you can see the red marking ⇒ Fig. 71 ② .

Folding back the rear seat backrest

Fold back the rear seat backrest and push it firmly into the catch until it engages securely into place ⇒ ⚠ .

The rear seat backrest must always be securely engaged.

The red marking on the release button must no longer be visible ⇒ Fig. 71 ② .

 WARNING

Injuries can be caused if the rear seat backrests are folded forwards and backwards in an uncontrolled way and without taking due care.

While folding the rear seat backrest forward, always make sure that no people or animals are in its path.

Never fold the rear seat backrest forwards or backwards while the vehicle is in motion.

Ensure that the seat belt is not trapped or damaged when folding back the rear seat backrest.

Always keep hands, fingers, feet or other body parts away from the swivel area when folding the rear seat backrest forwards and backwards.

Ensure that each rear seat backrest engages securely, otherwise the seat belts for the rear seats will not offer maximum protection. This applies to the centre seat of the rear bench seat in particular. If a seat is occupied and the corresponding rear seat backrest has not engaged securely into place, the seat occupant and rear seat backrest may move forwards in the event of a sudden braking or driving manoeuvre or during accidents.

Adults and children must not use seats if the corresponding backrest is folded forwards or is not engaged securely into place.

 NOTICE

Damage to the vehicle or to other objects could be caused if the rear bench seat backrest is folded forwards and backwards in an uncontrolled way or without due care.

Before folding the rear seat backrests forwards, always adjust the front seats so that the rear head restraints or rear seat cushions do not impact the front seats.

Before folding down the rear seat backrest, always make sure that there are no objects located in its path.

Head restraints

 Introduction

This chapter contains information on the following subjects:

⇒ Adjusting the head restraints

⇒ Removing and installing head restraints

The following section describes the options for adjusting and removing the head restraints. Always ensure that you adjust the correct sitting position ⇒ Sitting position .

Every seat is fitted with a head restraint. The centre head restraint at the rear is designed solely for use with the centre rear bench seat. Therefore you should not install this head restraint in any of the other positions.

Correct head restraint adjustment

Adjust the head restraint so that its upper edge is at the same height as the top of the head, but not lower than eye level. Position the back of your head as close to the head restraint as possible.

Head restraint adjustment for small people

Push the head restraint all the way down, even if the head is then located underneath the top edge of the head restraint. There may be a small gap between the head restraint and backrest in the lowest position.

Head restraint adjustment for tall people

Push the head restraint up as far as it will go.

WARNING

Driving without head restraints or with incorrectly adjusted head restraints increases the risk of serious or fatal injuries in the event of an accident or sudden driving or braking manoeuvre.

If a seat is occupied, the head restraint for that seat must be fitted and adjusted correctly.

Each vehicle occupant must adjust the head restraint to suit their body size in order to reduce the risk of neck injuries in an accident. The upper edge of the head restraint must, as far as possible, be level with the top of the head, but no lower than eye level. Position the back of your head in the middle and as close to the head restraint as possible.

Never adjust the head restraint when the vehicle is in motion.

NOTICE

When removing or fitting head restraints, make sure that they do not hit the roof, the front seat backrest or other vehicle parts. This will prevent damage from occurring.

Adjusting the head restraints

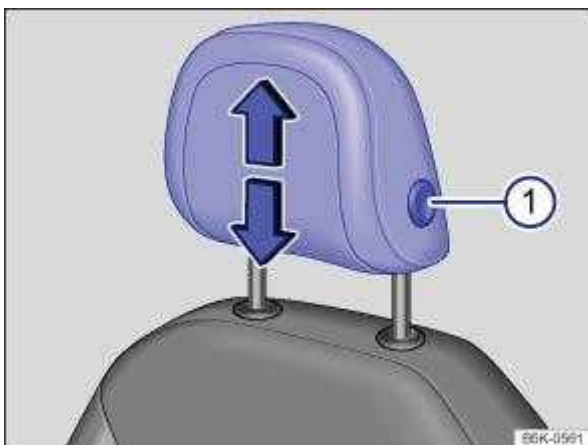

Fig. 72 Front head restraint: adjusting.

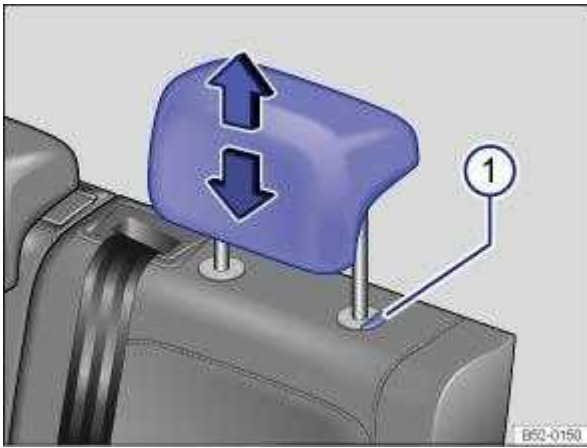

Fig. 73 Rear head restraint: adjusting.



First read and observe the introductory information and safety warnings ⇒ Introduction

Adjusting the height of the front head restraint

Press the button ⇒ Fig. 72 ① or ⇒ Fig. 73 ① if necessary and slide the head restraint up or down in the direction of the arrow ⇒ .

The head restraint must click securely into position.

Removing and installing head restraints

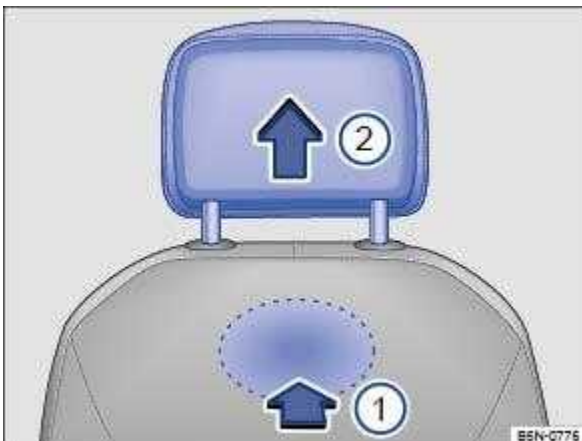

Fig. 74 Front head restraint: removing.

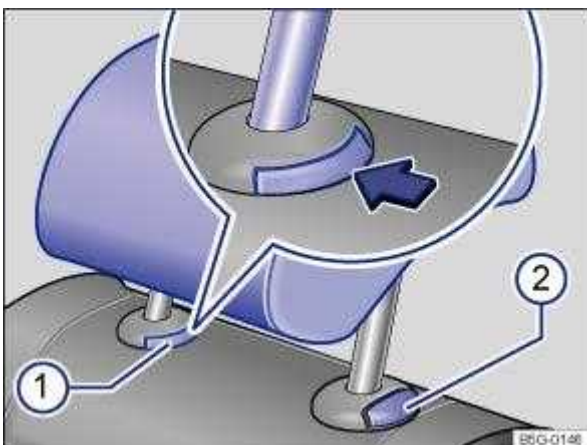





Fig. 75 Rear head restraint: removing.



First read and observe the introductory information and safety warnings ⇒  Introduction

Removing the front head restraints

Lower the head restraint if necessary ⇒  .

To release the head restraint, feel for the recess in the marked area on the rear side and press it in the direction of the arrow ⇒ Fig. 74  .

Pull the head restraint out in the direction of the arrow ⇒ Fig. 74  .

Fitting the front head restraints

Position the head restraint correctly over the head restraint guides and then insert into the guides of the corresponding seat backrest.

Slide the head restraint all the way down until the guide pins click into place.

Adjust the head restraint so a correct sitting position can be assumed.

Removing the rear head restraints

Release the rear bench seat backrest and fold the backrest forwards.

Push the head restraint all the way up ⇒  .

Press button ⇒ Fig. 75  on the head restraint guide.

At the same time, press button  while a second person pulls the head restraint out fully.

Fold back the rear seat backrest and allow it to engage securely.

Fitting the rear head restraints

Release the rear bench seat backrest and fold the backrest forwards.

Position the head restraint correctly over the head restraint guides and then insert into the guides of the corresponding seat backrest.

Press and hold the button ⇒ Fig. 75  and push down the head restraint.

Fold back the rear seat backrest and allow it to engage securely.

Adjust the head restraint so that a correct sitting position can be assumed ⇒ Sitting position .

Seat functions

Centre armrest

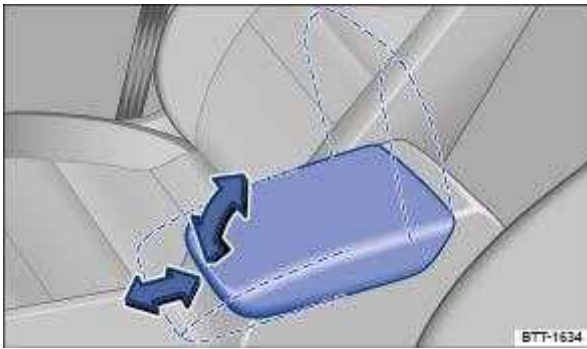

Fig. 76 Front centre armrest.

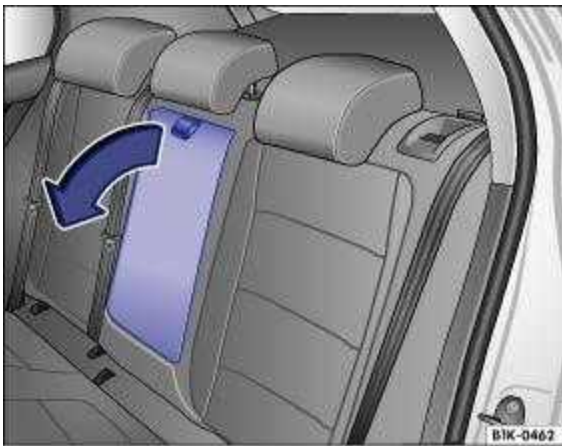

Fig. 77 Rear fold-out centre armrest.

Front centre armrest

To move it backwards and forwards: push the centre armrest in the direction of the arrow all the way forwards ⇒ Fig. 76 , or all the way backwards.

Rear centre armrest

There may be a centre armrest in the rear seat backrest that can be folded out of the middle seat.

To fold it down, pull the loop in the direction of the arrow ⇒ Fig. 77 .

To fold it back: fold the centre armrest upwards in the opposite direction of the arrow ⇒ Fig. 77 and push it into the backrest as far as it will go.

WARNING

When fully open or not completely closed, the front centre armrest can restrict the freedom of movement of the driver's arms and therefore cause accidents and serious injuries.

Always keep stowage compartments closed while the vehicle is in motion.

Never transport an adult or child on the centre armrest. An incorrect seating position can cause serious injury.

 **WARNING**

The rear centre armrest must always be folded up while the vehicle is in motion in order to reduce the risk of injury.

The middle seat on the rear bench seat must never be used when the centre armrest is folded down – neither by adults nor children. An incorrect sitting position can cause severe injuries.

Lights

Turn signals

Switching turn signals on and off

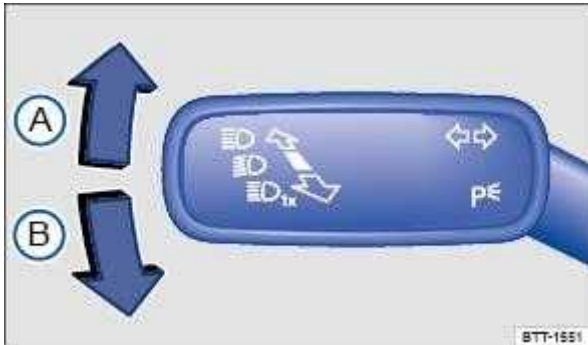

Fig. 78 On the left of the steering column: turn signal and main beam lever.

Switch on the ignition.

Move the turn signal and main beam lever ⇒ Fig. 78 from the centre position to the following position:

A

Right turn signal ➡.

B

Left turn signal ⬅.

Return the turn signal and main beam lever to the basic position in order to switch off the turn signal.

Go to a qualified workshop if the acoustic signal does not sound when a turn signal is switched on and have the vehicle checked.

Convenience turn signal

To operate the convenience turn signal, push the turn signal and main beam lever up or down to the pressure point and then release the lever. The turn signal flashes three times.

To cancel the convenience turn signal, immediately move the lever in the opposite direction up to the pressure point and then release it.

The convenience turn signal can be activated and deactivated in the Infotainment system in the Vehicle settings menu ⇒ Infotainment system controls and displays .

 **WARNING**

Incorrect use of turn signals, a failure to use turn signals, or forgetting to switch off a turn signal can confuse other road users. This could lead to accidents and serious injuries.

Always activate the turn signal in good time when changing lanes and performing overtaking or turning manoeuvres.

Always switch off the turn signal once the lane change or overtaking or turning manoeuvre has been completed.



The hazard warning lights also work when the ignition is switched off ⇒ In an emergency .



Some settings can be stored in the user accounts of the personalisation function and therefore change when the user account changes ⇒ Personalisation .

Vehicle lighting

Switching lights on and off





Fig. 79 Next to the steering wheel: light switch (one variant).

Switching lights on

Switch on the ignition.



Turn the light switch to the appropriate position:

AUTO Automatic headlights: dipped beam is switched on or off depending on the brightness level and the weather ⇒  , ⇒ Automatic headlights **AUTO** .  The side lights and daytime running lights are switched on. The symbol in the light switch lights up green.  The dipped beam headlights are switched on.

Switching lights off

Switch off the ignition.

Turn the light switch to the appropriate position:

0 The lights are switched off. **AUTO** Leaving Home function (orientation lighting) can be switched on ⇒ Coming Home and Leaving Home function (orientation lighting) .  Side lights or continuous parking light on both sides of the vehicle switched on ⇒ Switching the parking lights on and off . The symbol in the light switch lights up green.  Dipped beam is switched off – the side lights will stay on as long as the vehicle key is in the ignition lock or, in vehicles with Keyless Access, the driver door is closed.

Daytime running lights

The daytime running lights (dependent on equipment level) can increase the visibility of your vehicle in traffic during the day.

The daytime running lights are switched on every time the ignition is switched on when the light switch is in position **0**,  or **AUTO** (when brightness is detected).

The daytime running lights cannot be switched on or off manually.

 **WARNING**

Accidents and serious injuries can occur if the road is not sufficiently illuminated and other road users have difficulty seeing the vehicle, or cannot see it at all.

The light assist systems are designed only to provide support; the driver is responsible for the correct vehicle lights being switched on.

Always switch on the dipped beam headlights if it is dark, raining or visibility is poor.

 **WARNING**

The side lights or daytime running lights are not bright enough to illuminate the road ahead and to ensure that other road users are able to see you.

Always switch on the dipped beam headlights if it is dark, raining or visibility is poor.

The tail light clusters are not switched on with the daytime running lights. If the tail light clusters are not switched on, the vehicle may not be visible to other road users if it is dark, raining, or if visibility is poor.

 **WARNING**



The automatic headlights (**AUTO**) switch dipped beam on and off only when there is a change in the level of brightness.



Switch on dipped beam manually if required by the weather conditions, e.g. in fog.



When reverse gear is engaged, the cornering light on both sides of the vehicle switches on to provide better illumination of the surrounding area when manoeuvring.

Switching the fog lights on and off

Switching on the front fog lights : pull the light switch ⇒ Fig. 79 out to the first position. The indicator lamp  in the light switch lights up green.

Switching on the rear fog light : pull the light switch all the way out. The indicator lamp  in the instrument cluster lights up yellow.

To switch the fog lights off, press in the light switch or turn it to position **0**.



When the automatic headlights **AUTO** are switched on and the front or rear fog lights are switched on, the dipped beam headlights will also be switched on irrespective of the current light conditions outside.



In vehicles with a factory-fitted towing bracket: the vehicle's rear fog light is not switched on if a trailer with rear fog light is electrically connected to the vehicle ⇒ Trailer towing .

Light functions

Side lights

If the side lights  are switched on, both headlights light up with the side lights, parts of the tail light clusters, the number plate lighting and the buttons in the centre console and the dash panel. The daytime running lights also switch on when the ignition is switched on.

If the vehicle is not locked from outside when the ignition is switched off, the continuous parking light on both sides of the vehicle switches on automatically after around 10 minutes to reduce 12-volt vehicle battery discharge ⇒ Switching the parking lights on and off .

Automatic headlights **AUTO**

If the automatic headlights **AUTO** are switched on, the vehicle lighting and the instrument and switch lighting will switch on and off according to the light conditions. When the lights are switched on, the indicator lamp lights up yellow.

The automatic headlights are merely an aid and will not always be able to detect all driving situations.

In vehicles with a corresponding equipment level, the switch-on time of the automatic headlights can be adjusted in the Infotainment system in the Vehicle settings menu ⇒ Infotainment system controls and displays .



Cornering light

A cornering light is switched on when turning slowly or travelling around very tight bends.

Signal tones if lights are not switched off

If the vehicle key has been removed from the ignition lock and the driver door opened, acoustic warnings sound under the following conditions:

If the parking light is switched on.

If the side lights are switched on  or the rear fog light is switched on .

When the Coming Home function is switched on, no signal tone will be given as a reminder that a light is still switched on when leaving the vehicle.



Some settings can be stored in the user accounts of the personalisation function and therefore change when the user account changes ⇒ Personalisation .

Troubleshooting

Turn signal indicator lamp

If a turn signal on the vehicle has failed, the indicator lamp will start flashing twice as fast.

The indicator lamp flashes green.

Check the lighting and change the appropriate bulb as required ⇒ Changing bulbs .

If the problem persists, go to a qualified workshop.

Does not apply in China and Japan: trailer turn signals indicator lamp

The indicator lamp goes out if a trailer turn signal or all trailer lights stop working.

The indicator lamp flashes green.

Check the lighting and change the appropriate bulb as required ⇒ Changing bulbs .

If the problem persists, go to a qualified workshop.

Vehicle lighting not working

Vehicle lighting has failed either completely or partially.

The indicator lamp lights up yellow.

Check the lighting and change the appropriate bulb as required ⇒ Changing bulbs .

If the problem persists, go to a qualified workshop.

Fault in rain/light sensor

In the light switch position **AUTO**, the vehicle lighting is not switched on or off automatically.

The indicator lamp lights up yellow.

Switch the ignition off and on.

If the problem persists, go to a qualified workshop.

Main beam

Switching main beam on and off

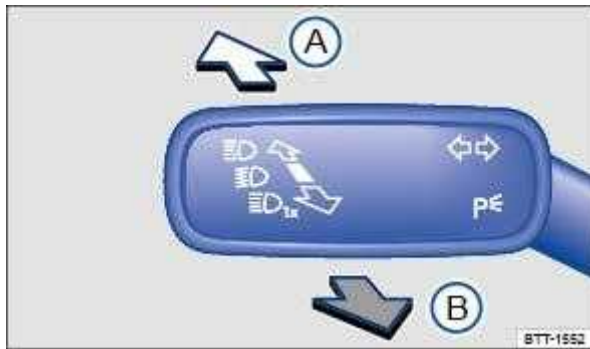



Fig. 80 On the left of the steering column: turn signal and main beam lever.

Switch on the ignition and dipped beam.

Move the turn signal and main beam lever from the centre position to the following position:

A Main beam switched on.

B Operate the headlight flasher or switch off the main beam. The headlight flasher comes on for as long as the lever is pulled.

When the main beam or headlight flasher are switched on, the blue indicator lamp  lights up in the instrument cluster.

Main-beam control

Depending on the vehicle equipment level, advanced main-beam control may also be available
⇒ Main-beam control .

WARNING

Incorrect use of the main beam headlights can lead to accidents and serious injuries as the main beam headlights could distract and dazzle other road users.

Main-beam control

The main-beam control automatically dips the headlights when oncoming vehicles and/or vehicles driving in front are detected. Main-beam control also recognises illuminated areas such as towns and deactivates the main beam while driving through them.

Within the limits of the system, main-beam control automatically switches main beam on at speeds of over approximately 60 km/h (37 mph), depending on ambient and traffic conditions, and switches it off again at speeds under approximately 30 km/h (18 mph) ⇒  .

With some equipment levels, the main-beam control can be activated and deactivated in the Infotainment system in the Vehicle settings menu ⇒ Infotainment system controls and displays .

Switching on main-beam control

Switch on the ignition and the automatic headlights **AUTO**.

Tap the turn signal and main beam lever forwards from the basic position.

When main-beam control is switched on, the indicator lamp  lights up in the instrument cluster display.

Switching off main-beam control

Pull back the turn signal and main beam lever.

OR: switch off the automatic headlights **AUTO**.

OR: switch off the ignition.

OR: push the turn signal and main beam lever forwards to switch on the manual main beam.

System limits

The main beam must be manually switched off under the following conditions, as it is not switched off by the main-beam control in time or at all:

In poorly lit streets where there are highly-reflective signs.

Other road users with insufficient lighting facilities, such as pedestrians, cyclists.

In tight bends, with half-hidden oncoming traffic, on steep crests or in dips.

With oncoming traffic on roads with a central barrier where the driver can see clearly over the central barrier e.g. truck drivers.

In fog, snow or heavy rain.

In conditions with swirled-up dust and sand.

If the windscreen is damaged in the camera's field of vision.

If the camera's field of vision is covered by condensation, dirt, a sticker, or by snow or ice.

If the camera is faulty or the power supply is interrupted.

 **WARNING**

Do not let the extra convenience afforded by main-beam control tempt you into taking any risks when driving. The system is not a substitute for the full concentration of the driver.

Always check the vehicle lights yourself and adapt them to the prevailing conditions for light, visibility and road traffic.

The main-beam control may not be able to recognise all driving situations correctly and may not work properly in certain situations.

If the camera's field of view is dirty, covered or damaged, the function of the main-beam control may be impaired. This also applies if changes are made to the vehicle's lighting system, for example if additional headlights are fitted.

! NOTICE

Please observe the following points in order to avoid impairing the proper function of the system:

Regularly clean the camera's field of view, and keep it free from snow and ice.

Do not cover the camera's field of view.

Regularly check the area of the windscreen that is in the camera's field of view for damage.



Light-emitting objects in the camera's field of operation, e.g. mobile navigation devices, can impair the functions of the main-beam control system.

Parking light

Switching the parking lights on and off

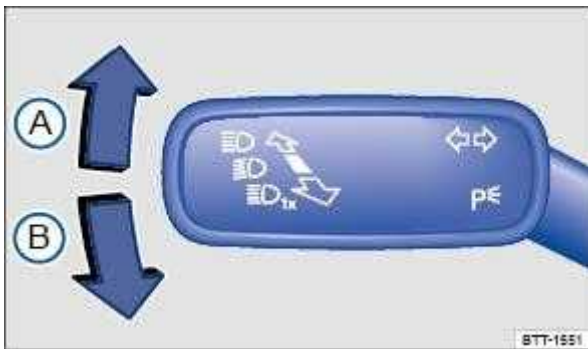

Fig. 81 On the left of the steering column: turn signal and main beam lever.

Switching on parking light on one side of the vehicle

When the parking lights are switched on, the headlight with side light and parts of the tail light cluster on the corresponding side of the vehicle light up:

Switch off the ignition.

Move the turn signal and main beam lever from the centre position to the following position:



The right-hand parking light is switched on.



The left-hand parking light is switched on.

Continuous parking light on both sides of the vehicle

Both headlights light up with side lights as well as parts of the tail light clusters if the continuous parking light on both sides of the vehicle is switched on:

With the ignition on, turn the light switch to position

Switch off the ignition.

Lock the vehicle from the outside.

Automatic switch-off of side lights and parking lights

If the battery capacity is not sufficient for the side lights or parking light to remain switched on for two hours, the 12-volt vehicle battery can be discharged to such an extent that it is no longer possible to start the engine ⇒ ⚠.

In the case of standing times of more than two hours, the vehicle will detect a weak 12-volt vehicle battery and switch off the side lights or parking light so that the engine can still be started.

WARNING

Accidents and serious injuries can occur if the vehicle is parked without sufficient illumination, as other road users might have difficulty seeing the vehicle, or may not see it at all.

Always park the vehicle safely and with sufficient lighting. Observe any applicable local regulations.

If the vehicle lighting is required for several hours, switch on the right or left parking light if possible. The illumination time of the parking light on one side is generally twice as long as for continuous parking light on both sides of the vehicle.

Coming Home and Leaving Home function (orientation lighting)

The Coming Home and Leaving Home function lights up the area immediately surrounding the vehicle when you get in or out of the vehicle in darkness.

Not in China: the Coming Home function is switched on manually. In contrast, the Leaving Home function is controlled automatically by a rain/light sensor.

Only in China: the Coming Home and Leaving Home function is controlled automatically by a rain/light sensor.

The switch-off delay can be adjusted and the function activated or deactivated in the Vehicle settings menu in the Infotainment system ⇒ Infotainment system controls and displays .

Activating the Coming Home function

Not in China

Switch off the ignition.

Operate the headlight flasher for approximately one second.

The Coming Home lighting is switched on when the driver door is opened. The switch-off delay starts when the last vehicle door or the boot lid has been closed.

Activating the Coming Home function

Only in China

Switch off the ignition.

The Coming Home lighting is switched on when the light switch is in position **AUTO** and the rain/light sensor detects that it is dark.

The switch-off delay starts when the last vehicle door or the boot lid has been closed.

Deactivating the Coming Home function

Automatically after the selected switch-off delay has elapsed.

OR: automatically if a door or the boot lid is still open approximately 30 seconds after switching on.

OR: turn light switch to position **0**.

OR: switch on the ignition.

Activating the Leaving Home function

Unlock the vehicle when the light switch is in position **AUTO** and the rain/light sensor detects that it is dark.

Deactivating the Leaving Home function

Automatically after the switch-off delay.

OR: lock the vehicle.

OR: turn light switch to position **0**.

OR: switch on the ignition.



Some settings can be stored in the user accounts of the personalisation function and therefore change automatically when the user account changes ⇒ Personalisation .

Headlights

Headlight range control



Fig. 82 In the Infotainment system: slider for headlight range control.

Headlight range control can be used to adjust the light cone of the dipped beam headlights to the vehicle load level. This gives the driver the best visibility possible and means that oncoming traffic will not be dazzled ⇒ ⚠ .

With some equipment levels, the headlight range can be adjusted with the slider in the Infotainment system ⇒ Fig. 82 .

Manual headlight range control

Press the **MENU** button or function button.

Touch the Vehicle and  function buttons to open the Vehicle settings menu.

Touch the Lights function button to open the Light settings menu.

Touch the Headlight range control ⇒ Fig. 82  function button.

Move the slider to the required position (typical vehicle load level).

Setting in the Infotainment system	
0	Front seats occupied and luggage compartment empty.
2	All seats occupied and luggage compartment empty.
4	All seats occupied and luggage compartment fully loaded. Towing a trailer with a low drawbar load ⇒ Trailer towing .
6	Only the driver seat is occupied and the luggage compartment is fully loaded. Towing a trailer with maximum drawbar load ⇒ Trailer towing .

Dynamic headlight range control

The headlight range cannot be adjusted manually if the vehicle has dynamic headlight range control. The headlight range is automatically adapted to suit the vehicle load level as soon as the headlights are switched on ⇒  .

WARNING

Heavy objects in the vehicle can cause the headlights to dazzle and distract other road users. This could lead to accidents and serious injuries.

The light cone should always be adjusted to the load level of the vehicle to ensure that other road users are not dazzled.

WARNING

Failure or a malfunction of the dynamic headlight range control can cause the headlights to dazzle or distract other road users. This could lead to accidents and serious injuries.

The headlight range control should be checked by a qualified workshop as soon as possible.

Switching over headlights for driving abroad (travel mode)

If you have to drive a right-hand drive vehicle in a left-hand drive country, or vice versa, the asymmetric dipped beam headlights may dazzle oncoming traffic. The headlights must therefore be switched over when you travel to these countries.

With some equipment levels, the headlight alignment can be adjusted in the Infotainment system in the Vehicle settings menu ⇒ Infotainment system controls and displays .

In vehicles in which the headlights cannot be switched over in the menu, masking stickers should be applied to certain parts of the headlight lenses, or the headlights should be adjusted by a qualified workshop. A qualified workshop can provide you with further information. Volkswagen recommends using a Volkswagen dealership for this purpose.



Travel mode may be used only for a short period. Please contact a qualified workshop for a permanent conversion. Volkswagen recommends using a Volkswagen dealership for this purpose.

Interior lighting

Instrument and switch lighting

The brightness of the instrument and switch lighting can be adjusted in the Infotainment system in the Vehicle settings menu ⇒ Infotainment system controls and displays .

The brightness setting is automatically adjusted to the changing light conditions in the vehicle.



When the light switch is in position **AUTO**, a sensor will switch the dipped beam and the lighting in the instruments and switches on and off automatically depending on the ambient brightness level.



When the light is switched off and the ignition switched on, the instrument and switch lighting (needles and scales) is switched on. As the ambient light becomes lower, the illumination of the scales is automatically reduced and may be switched off entirely. This function is intended to remind the driver to switch on the dipped beam in good time, i.e. when driving through tunnels.

Interior and reading lights

Press the appropriate button or move the switch to the appropriate position:

 Switch off the interior light.  Switch on the interior lights. The interior lights are switched on automatically when the vehicle is unlocked, a door is opened or the vehicle key is removed from the ignition.  Switch the reading light on or off.

Stowage compartment and luggage compartment lights

A light will be switched on and off when the stowage compartment on the front passenger side or the boot lid is opened or closed.

Background lighting

Depending on the equipment level, the background lighting provides indirect light in various areas of the vehicle interior.

The front footwell may also be illuminated.

The brightness of the background lighting can be adjusted in the Infotainment system in the Vehicle settings menu ⇒ Infotainment system controls and displays .



The lights go out when the vehicle is locked or after a delay of a few minutes when the vehicle key is removed from the ignition lock. This prevents the 12-volt vehicle battery from discharging.



Some settings can be stored in the user accounts of the personalisation function and therefore change automatically when the user account changes ⇒ Personalisation .

Visibility

Wipers

Operating the wiper lever

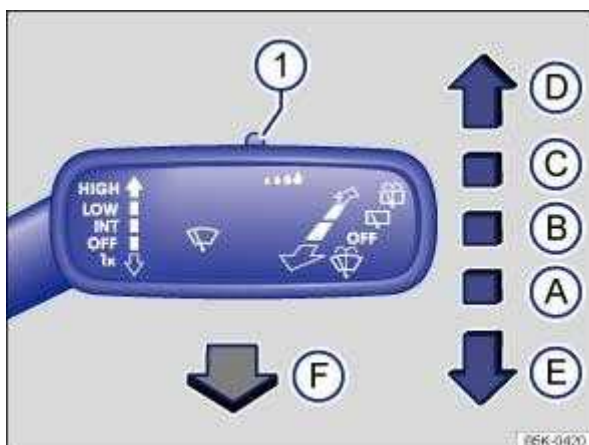

Fig. 83 On the right of the steering column: operating the windscreen wipers.

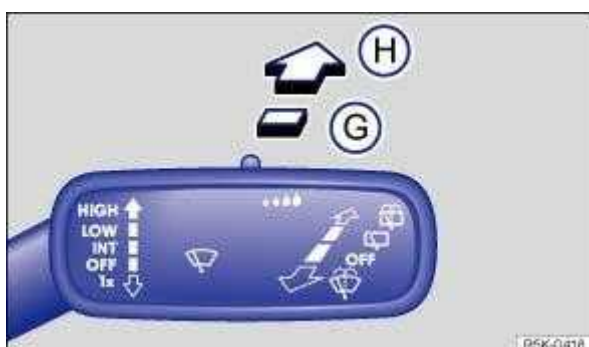

Fig. 84 On the right of the steering column: operating the rear window wiper.

The wipers will work only when the ignition is switched on and the bonnet and boot lid are closed.

Move the wiper lever to the desired position ⇒ :

A OFF Wipers switched off.

B INT Interval wipe for the windscreen or rain/light sensor mode. The interval wipe for the windscreen depends on the speed of the vehicle. The wipers will wipe more frequently as the vehicle moves faster.

C LOW Slow wipe.

D HIGH Fast wipe.

E 1x Flick wipe – brief wiping. Push down and hold the lever for longer to wipe more quickly.

F  Pulling the lever activates the wash and wipe system for cleaning the windscreen. Climatronic will switch to air recirculation mode for approximately 30 seconds to prevent the smell of the washer fluid from entering the vehicle interior.

1  Switch for interval settings (vehicles without a rain/light sensor) or adjusting the sensitivity of the rain/light sensor.

G  Interval wipe for the rear window. The wiper will wipe the window approximately every six seconds.

H  Pushing the lever activates the wash and wipe system for cleaning the rear window.

 **WARNING**

Without an adequate amount of anti-freeze, the washer fluid can freeze on the windscreen and obscure your view.

In winter temperatures, use the windscreen washer system only when adequate anti-freeze has been added to the washer fluid.

Never use the windscreen washer system at winter temperatures before the windscreen has been heated by the ventilation system. The anti-freeze mixture may otherwise freeze on the windscreen and restrict vision.

 **WARNING**

Worn or dirty wiper blades reduce visibility and increase the risk of accidents and serious injuries.

Always change wiper blades if they are damaged or worn and no longer clean the windows properly
⇒ Wiper blades .

 **NOTICE**

Before setting off and before switching on the ignition, always check the following to avoid damage to the windscreen, the wiper blades and the wiper motor:

The wiper lever is located in the basic position.

Snow and ice have been removed from the wiper blades and door windows.

Wiper blades that have become frozen onto the glass have been carefully loosened. Volkswagen recommends using a de-icer spray for this.

NOTICE

Do not switch on the wipers when the window is dry. Using the wipers when the window is dry can damage the glass.



When switched on, the wipers will temporarily be switched to the next setting down when the vehicle is stationary.



When parking the vehicle in cold weather, it may be helpful to leave the front windscreen wipers in the service position to make it easier to loosen the wiper blades ⇒ Wiper blades .

Wiper function

Automatic activation of the rear window wiper

The rear window wiper is switched on automatically if the windscreen wipers are switched on and reverse gear is engaged. Automatic switch-on when reverse gear is selected can be activated and deactivated in the Infotainment system in the Vehicle settings menu ⇒ Infotainment system controls and displays .

Heated washer jets

The heating defrosts frozen washer jets. The heating output is automatically regulated depending on the ambient temperature when the ignition is switched on. Only the jets are heated, not the hoses that the washer fluid flows through.

Rain/light sensor

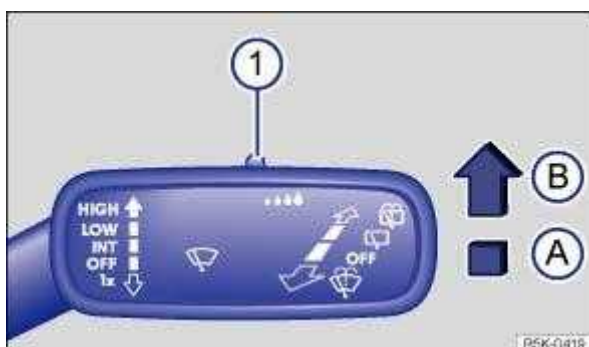

Fig. 85 On the right of the steering column: wiper lever.

When the rain/light sensor is activated, it automatically controls the frequency of the wiper intervals depending on the intensity of the rain.

Activating and deactivating the rain/light sensor

Position **A** - the rain/light sensor is deactivated.

Position **B** - the rain/light sensor is activated, automatic wipe when necessary.

The automatic wipe function can be activated and deactivated in the Infotainment system in the Vehicle settings menu ⇒ Infotainment system controls and displays .

If the automatic wipe function is deactivated in the Infotainment system, the intervals are set at fixed levels.

Adjusting the sensitivity of the rain/light sensor

The sensitivity of the rain/light sensor can be adjusted manually using the switch in the wiper lever ⇒ Fig. 85 **1** ⇒  .

Switch to the right – high sensitivity.

Switch to the left – low sensitivity.



The rain/light sensor cannot always adequately detect all precipitation and activate the wipers correspondingly.

If necessary, switch on the wipers manually in good time if the water on the windscreen restricts the field of vision.



Some settings can be stored in the user accounts of the personalisation function and therefore change automatically when the user account changes ⇒ Personalisation .

Troubleshooting

 Washer fluid level too low

The indicator lamp lights up yellow.

Fill up the washer fluid reservoir at the next opportunity ⇒ Washer fluid

 Fault in rain/light sensor

The wipers are not switched on automatically if it rains during rain/light sensor operation.

The indicator lamp lights up yellow.

Switch the ignition off and on.

If the problem persists, go to a qualified workshop.

Fault in wipers

The wipers do not wipe.

The indicator lamp lights up yellow.

Switch the ignition off and on.

If the problem persists, go to a qualified workshop.

Changes in the activation behaviour of the rain/light sensor

Possible causes for faults and misinterpretations relating to the sensitive surface of the rain/light sensor ⇒ Vehicle overviews include:

Damaged wiper blades: a film of water or smears caused by damaged wiper blades can increase the time the wipers are switched on, can shorten the length of the intervals between wipes or cause the wipers to run quickly and continuously.

Insects: insects hitting the windscreen can cause the wipers to be activated.

Salt deposits: in winter, salt deposits can cause the wipers to continue to wipe the windscreen when it is almost dry.

Dirt: dry dust, wax, windscreen coatings (lotus effect), or detergent deposits (from an automatic car wash) can cause the rain/light sensor to become less sensitive and react too slowly, or prevent it from reacting at all. Clean the sensitive surface of the rain/light sensor ⇒ Caring for and cleaning the vehicle exterior at regular intervals and inspect the wiper blades for damage.

Crack in the windscreen: a wipe cycle will be triggered if the rain/light sensor is on when the windscreen is impacted by a stone. The rain/light sensor will then register the impairment of the sensitive surfaces and adjust accordingly. Depending on the size of the stone impact, the activation behaviour of the rain/light sensor may be changed.

We recommend that you use an alcohol-based glass cleaner to remove wax and polish.



The wipers will try to wipe away any obstacles that are on the window. The wiper will stop moving if the obstacle continues to block its path. Remove the obstacle and switch the wiper back on again.

Mirrors

Introduction

This chapter contains information on the following subjects:

⇒ Interior mirror

⇒ Exterior mirrors

You can use the exterior mirrors and the interior mirror to observe traffic behind you and adjust your driving style accordingly.

For safety reasons, it is important that the driver positions the exterior and interior mirrors correctly before starting a journey ⇒ ⚠ .

Looking in the exterior mirrors and the interior mirror does not allow the driver to see the entire side and rear area around the vehicle. The area that cannot be seen is known as the blind spot. There may be objects and other road users in the blind spot.

 WARNING

Adjusting the exterior and interior mirrors while the vehicle is moving may cause the driver to become distracted. This could lead to accidents and serious injuries.

Exterior and interior mirrors should be adjusted only when the vehicle is at a standstill.

When parking, changing lane, or performing an overtaking or turning manoeuvre, always pay careful attention to the area around the vehicle as objects and other road users may be located in the blind spot.

Always ensure that the mirrors are positioned correctly and that the rear view is not restricted by ice, snow, condensation or any other objects.

 WARNING

If you estimate the distance from traffic behind you incorrectly, you can cause accidents and serious injuries.

Curved mirrors (convex or aspheric) enlarge the field of vision and can make objects in the mirror seem smaller and further away than they actually are.

Using curved mirrors to estimate the distance from other vehicles behind you when changing lanes can provide inaccurate results and can lead to accidents and serious injuries.

Whenever possible, use the interior mirror to check the exact distance between your vehicle and following traffic or other objects.

Ensure that you have a good view to the rear of the vehicle.

 WARNING

Automatic anti-dazzle mirrors contain an electrolyte fluid which could leak if the mirror is broken.

The leaking electrolyte fluid can cause irritation to the skin, eyes and respiratory organs, especially in people who suffer from asthma or similar illnesses. Immediately ensure that there is a sufficient supply of fresh air and get out of the vehicle. If this is not possible, open all of the windows and doors.

If the electrolyte fluid gets into the eyes or onto the skin, immediately wash the area with plenty of water for at least 15 minutes and consult a doctor.

If the electrolyte fluid gets onto shoes or clothing, wash immediately with plenty of water for at least 15 minutes. Clean shoes and clothes thoroughly before wearing them again.

If the electrolyte fluid is swallowed, immediately rinse the mouth with plenty of water for at least 15 minutes. Do not induce vomiting unless instructed to do so by a doctor. Seek medical assistance immediately.

 NOTICE

If the glass of an automatic anti-dazzle mirror is broken, electrolyte fluid can leak from the mirror. This fluid corrodes plastic surfaces. Remove the fluid as soon as possible, e.g. using a wet sponge.

Interior mirror

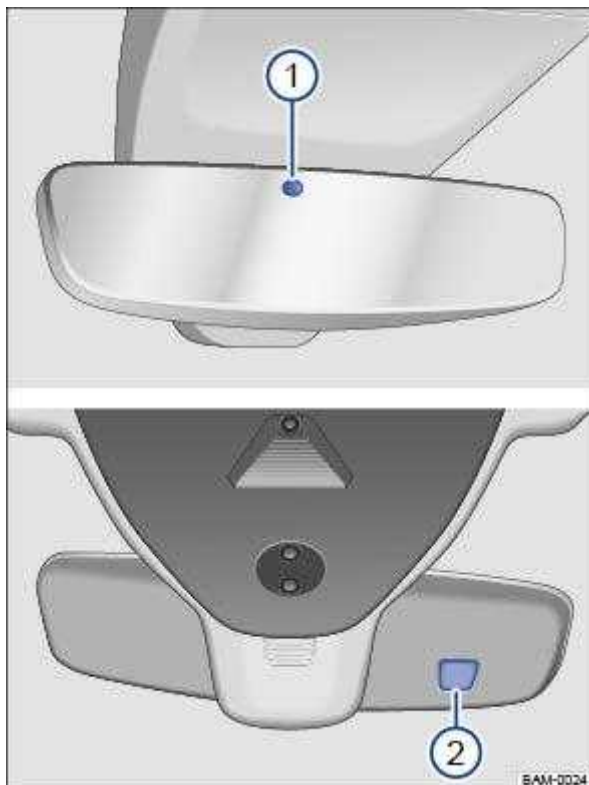

Fig. 86 On the windscreen: automatic anti-dazzle interior mirror.

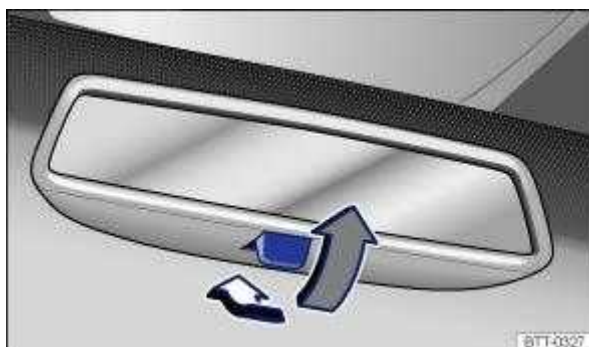



Fig. 87 On the windscreen: manual anti-dazzle interior mirror.



First read and observe the introductory information and safety warnings⇒  Introduction

Automatic anti-dazzle interior mirror

When the ignition is switched on, the sensors measure the incident light from the rear ⇒ Fig. 86 ① and from the front ②.

Depending on the values measured, the interior mirror dips automatically.

If the incident light on the sensors is hindered or interrupted, e.g. by a sun blind or other hanging objects, the automatic anti-dazzle interior mirror will not function or will not function correctly. Mobile navigation systems fitted to the windscreen or near the interior automatic anti-dazzle interior mirror can also affect the sensors ⇒ ⚠.

The automatic anti-dazzle function will be deactivated in some situations, e.g. when reverse gear is engaged.

Manual anti-dazzle interior mirror

Basic position: the lever on the lower part of the mirror is pointing towards the windscreen.

Pull the lever to the back to use the anti-dazzle function ⇒ Fig. 87 .

⚠ WARNING

The illuminated display from a mobile navigation device can lead to malfunctions of the interior automatic anti-dazzle mirror and cause accidents or serious injuries.

You may not be able to precisely determine the distance from vehicles travelling behind you or from other objects if the automatic anti-dazzle function malfunctions.

Exterior mirrors





Fig. 88 In the driver door: rotary knob for the exterior mirrors.

📖 First read and observe the introductory information and safety warnings ⇒ ⚠ Introduction

Switch on the ignition.

Turn the rotary knob in the driver door to the desired symbol ⇒ Fig. 88 .

Swivel the rotary knob forwards, backwards, right or left in the direction of the arrow in order to adjust the exterior mirror.

 Electrically fold in the exterior mirrors ⇒  .  Switch on the exterior mirror heating. The exterior mirror heating heats only at ambient temperatures below +20°C (+68°F) and initially with the highest setting. Heating takes place dependent on the ambient temperature after around two minutes. **L** Adjust the left-hand exterior mirror. **R** Adjust the right-hand exterior mirror. **0** Zero position. The exterior mirror cannot be adjusted and all functions are switched off.

Activating the exterior mirror functions

The following exterior mirror functions must be activated once in the Infotainment system in the Vehicle settings menu ⇒ Infotainment system controls and displays :

Synchronous mirror adjustment

Synchronous mirror adjustment means that the right-hand exterior mirror is also adjusted at the same time when you adjust the left-hand exterior mirror.

Turn the rotary knob to position **L**.

Adjust the left-hand exterior mirror. The right-hand exterior mirror will be adjusted at the same time (synchronously).

Correct the settings for the right-hand exterior mirror if necessary: swivel the rotary knob to position **R** and adjust the right-hand exterior mirror.

Folding in the exterior mirrors while parking

When the vehicle is locked or unlocked from the outside, the exterior mirrors fold in or out automatically. For this, the rotary knob must be in position , **L**, **R** or **0**.

If the rotary knob for the electrically adjustable exterior mirrors is in position , the exterior mirrors stay folded in.

Saving and recalling the front passenger exterior mirror settings for reversing

Unlock the vehicle with the vehicle key to which the settings should be assigned.

Switch on the electronic parking brake.

Switch on the ignition.

Put the gearbox into neutral.

Select reverse gear.

Adjust the front passenger exterior mirror so that you have a good view of the kerb area, for example.

The set mirror position will be saved and assigned to the vehicle key.

Turn the rotary knob for the exterior mirrors to position **R**.

Select reverse gear while the ignition is switched on. The right-hand exterior mirror moves to the saved position.

The front passenger exterior mirror will move out of the position saved for reversing when the vehicle is driven forwards faster than approximately 15 km/h (9 mph) or when the rotary knob is moved out of position **R** into another position.

 **WARNING**

Injuries can be sustained if you do not take care when folding the exterior mirrors in and out.

Fold the exterior mirrors in or out only when there is no obstruction in the path of the mirror.

Always ensure that no fingers are caught between the exterior mirror and the mirror base when the exterior mirrors are moved.

 **NOTICE**

Always fold in exterior mirrors before using an automatic car wash.

Do not fold electrically folding exterior mirrors in or out manually as this can damage the electric drive.



The exterior mirror heating should be switched off when it is no longer needed. If the heating is left on, this will result in unnecessary fuel consumption.



If there is a fault, the electric exterior mirrors can be adjusted by hand by pressing on the outside of the mirror.



Some settings can be stored in the user accounts of the personalisation function and therefore change automatically when the user account changes ⇒ Personalisation .

Protection from the sun

Sun visors

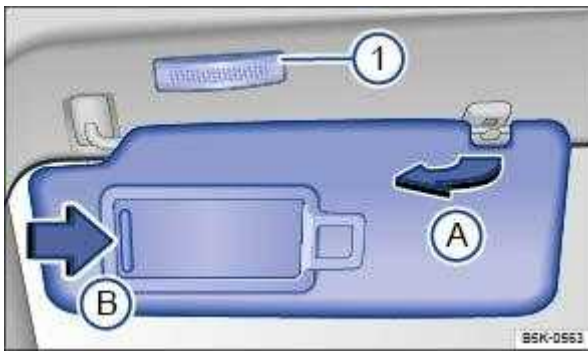

Fig. 89 In the front headliner: sun visor.

Adjustment options for the driver and front passenger sun visors:

Folded down over the windscreen.

Pulled out of the bracket and swung over towards the door ⇒ Fig. 89 (A).

Vanity mirrors

There is a vanity mirror in the folded-down sun visor. Depending on the vehicle equipment level, the vanity mirror may have a light.

When you open the cover ⇒ Fig. 89 (B), the lamp ⇒ Fig. 89 (1) lights up.

⚠ WARNING

Driving with the sun visors folded down and the sun blinds pulled out can reduce your view of the road.

Sun visors and sun blinds should always be replaced in their holder if they are not being used.



In certain circumstances, the lamp above the sun visor will go out automatically after a few minutes. This prevents the 12-volt vehicle battery from discharging.

Sun blind in the glass roof

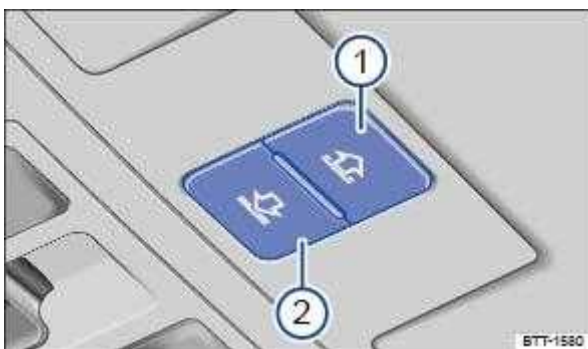

Fig. 90 In the roof: button for controlling the sun blind.

The electric sun blind works when the ignition is switched on.

When the glass roof is fully tilted, the sun blind is automatically moved to a ventilation position. The sun blind remains in the ventilation position even after the glass roof is closed.

Opening and closing the sun blind

The buttons ⇒ Fig. 90 ① or ② have two positions. In the first position, the sun blind can be completely or partially opened or closed.

In the second position, the sun blind automatically moves to the final position when the button is pressed briefly. Press the button again to stop the one-touch function.

Opening the sun blind: push button ① to position one. One-touch function: push button ① briefly to position two.

Closing the sun blind: push button ② to position one. One-touch function: push button ② briefly to position two.

Stopping the one-touch function when opening or closing the blind: push button ① or ② again.

The sun blind can still be opened or closed for several minutes after the ignition has been switched off, provided that the driver door and front passenger door are not opened.

Roll-back function of the sun blind

The roll-back function can reduce the risk of crush injury when closing the sun blind ⇒ . The glass roof or sun blind will open again immediately if the sun blind is unable to close because it is stiff or obstructed.

Check to see why the sun blind has not closed.

Try to close the sun blind again.

The sun blind will open again immediately if it is still unable to close because it is stiff or obstructed. After opening, the sun blind can be closed again within a short period of time without the roll-back function.

If the sun blind still cannot be closed, close it without the roll-back function.

Closing the sun blind without the roll-back function

Within approximately five seconds of the roll-back function being activated, press and hold button ⇒ Fig. 90 ② until the sun blind has closed completely.

The sun blind will now close without the roll-back function.

Please go to a qualified workshop if the sun blind still cannot be closed.

WARNING

Closing the sun blind without the roll-back function can cause serious injuries.

Always close the sun blind carefully.

Ensure that there is no one in the path of the sun blind, especially if it is closed when the roll-back function is not active.

The roll-back function does not prevent fingers or other body parts from being pressed against the roof frame and being injured.



When the glass roof is open, the electric sun blind can be closed only up to the front edge of the glass roof.

Heating and air conditioning system

Heating, ventilating, cooling



Introduction

This chapter contains information on the following subjects:

⇒ Front controls

⇒ Air recirculation mode

⇒ Seat heating

⇒ Steering wheel heating

⇒ Troubleshooting

The following systems may be installed in the vehicle

Both the manual air conditioning system and Climatronic heat, cool and dehumidify the air. It works most effectively when the windows and the glass roof are closed. If heat has built up in the vehicle interior, ventilating the vehicle can speed up the cooling process.

Display of activated functions

Lit up LEDs on rotary knobs and buttons indicate that the function is switched on.



WARNING

Poor visibility through the windows increases the risk of collisions and accidents, which can cause serious injuries.

Keep all windows free from ice, snow and condensation to maintain good visibility.

Adjust the heating, air conditioning system and rear window heating so that condensation does not form on the windows.

Only set off once all windows are clear.

Use air recirculation mode for a short period only. If the cooling system is switched off, condensation can form on the windows very quickly in air recirculation mode and reduce visibility considerably.

Switch off the air recirculation mode when it is no longer required.

 **WARNING**

Stale air can quickly make the driver tired and affect their concentration, which in turn can cause collisions, accidents and serious injuries.

Never switch off the blower or switch on the air recirculation mode for an extended period as this prevents fresh air from entering the vehicle interior.

 **NOTICE**

Food, medicine and other items that are sensitive to heat or cold could be either damaged or rendered useless by the air flowing out of the vents.

Never leave food, medicines or other temperature-sensitive objects in front of the vents.

 **NOTICE**

If the air conditioning system is not working, switch the air conditioning system off immediately and have it checked by a qualified workshop. This can help to prevent secondary damage.



Some settings can be stored in the user accounts of the personalisation function and therefore change automatically when the user account changes ⇒ Personalisation .

Front controls



Fig. 91 In the upper part of the centre console: air conditioning block for the manual air conditioning system and heating and fresh air system.



Fig. 92 In the upper part of the centre console: Climatronic air conditioning block.



First read and observe the introductory information and safety warnings ⇒ Introduction

Some functions and buttons may vary according to the vehicle equipment and the type of system installed.

MENU – Air conditioning settings in the Infotainment system

Press the **MENU** button in the air conditioning block to open the Climatronic air conditioning settings in the Infotainment system.

The upper part of the screen shows the current air conditioning settings.

Blue: cooling.

Red: heating.

Touch the function button to set the automatic control of air recirculation mode, the supplementary heater and the windscreen heating.

Touch the function button to switch cooling mode, air distribution and the blower on and off via the Infotainment system.

Touch the Presettings function button to set the automatic mode, the maximum cooling output, the defrost function and the manual mode of the cooling system via the Infotainment system.

Touch the function button to set the blower speed in **AUTO** mode.

Switching off

Press the **OFF** button in the air conditioning block (vehicles without auxiliary heater).

OR: touch the **OFF** function button on the Infotainment system.

Manual air conditioning system: turn the centre rotary control to position **0** ⇒ Fig. 91 .

Climatronic: turn the centre rotary control anti-clockwise as far as it will go ⇒ Fig. 92 .

Aircare – Climatronic with allergen filter

The allergen filter of the Air Care Climatronic can reduce the amount of pollutants and also allergens that enter the vehicle interior.

Press the **MENU** button in the air conditioning block.

Touch the Air Care function button.

Touch the Active function button to switch the Air Care function on or off.

SYNC – Synchronising the temperature settings

Press the **SYNC** button to adopt the temperature settings of the driver side for the front passenger side.

AUTO – Automatic mode

The automatic mode ensures constant temperatures in the vehicle interior. The air temperature, air quantity and air distribution are regulated automatically. Automatic mode switches off if ventilation is adjusted manually.

A/C – Cooling mode

Press the **A/C** button in the air conditioning block to switch cooling mode on or off.

In cooling mode, the air is dehumidified.

MAX A/C – Maximum cooling

Manual air conditioning system: turn the left rotary control to position **MAX A/C**. Air recirculation mode is switched on automatically.

Climatronic: press the **MAX A/C** button. Air recirculation mode is switched on automatically and the air distribution is set to the  position.



 /  – Temperature

Manual air conditioning system: turn the left rotary control ⇒ Fig. 91 .

Climatronic: turn the outer rotary controls ⇒ Fig. 92 to adjust the temperatures for the driver and front passenger sides.

The set temperatures are displayed above the rotary controls for Climatronic.

 – Seat and steering wheel heating

Press the buttons  or  to switch the seat heating on and off ⇒ Seat heating .

To operate the seat heating and steering wheel heating at the same time with the  button, link the two functions via the air conditioning settings in the Infotainment system ⇒ Switching the steering wheel heating on or off together with the seat heating (only for Climatronic) .

 – Auxiliary heater

Press the  button in the air conditioning block to switch the auxiliary heater on and off when the ignition is switched off ⇒ .

Touch the  function button in the Infotainment system air conditioning settings to access the Auxiliary heater menu ⇒ Auxiliary heater and ventilation .

The auxiliary heater provides additional heating when the ignition is switched on.

 – Blower

Turn the middle rotary control.

When Climatronic is in automatic mode, no blower speed is displayed in the rotary control.

 – Air recirculation mode

Press the  button.

Air distribution



 – air distribution to the upper body via the vents in the dash panel.

 – air distribution to footwell.

 – air distribution to the upper body and the footwell.

 – air distribution to the windscreen and the footwell.

 – air distribution to the windscreen.

MAX  |  – Defrost function

Manual air conditioning system: turn the right rotary knob to position  ⇒ Fig. 91 .

Climatronic: press the **MAX**  button ⇒ Fig. 92 .

Manual air conditioning system: in the defrost function, the air recirculation mode switches off and the air conditioning compressor for the cooling system switches on in order to dehumidify the air. When the defrost function is switched on, it is not possible to switch the air recirculation mode on or the air conditioning compressor off1).

 – Rear window heating

Press  to switch the rear window heating on or off while the engine is running.

The rear window heating will switch off after 10 minutes at the latest.

Recommended settings for manual air conditioning system

Switch off air recirculation mode.

Set blower to setting **1** or **2**.

Set the temperature selector to the middle position.

Open and position all vents on the dash panel.

Turn the air distribution regulator to the desired position.

Press the **A/C** button in the air conditioning block to switch the cooling system on.

Recommended settings for Climatronic

Press the **AUTO** button.

Set the temperature to +22°C (+72°F).

Open and position vents on the dash panel.

NOTICE

To prevent damage to the rear window heating, do not put stickers over the heating elements on the inside of the window.

1) The air conditioning compressor can be switched off in some countries.

Air recirculation mode



First read and observe the introductory information and safety warnings ⇒  Introduction

In air recirculation mode, no fresh air enters the vehicle interior.

Manual air recirculation mode

Press the  button in the air conditioning block to switch manual air recirculation mode on or off.

OR: touch the  function button in the air conditioning settings in the Infotainment system.

Automatic air recirculation mode of Climatronic

In the automatic air recirculation mode, fresh air will enter the vehicle interior. The air recirculation mode will switch on automatically if the system detects an increase in the concentration of noxious substances in the outside air. The air recirculation mode will switch off as soon as the level of noxious substances has returned to normal. The system cannot detect unpleasant odours.

Open the air conditioning settings in the Infotainment system.

Touch the  function button.

Touch the Automatic air recirculation function button.

When is air recirculation mode deactivated?

Air recirculation mode is deactivated in the following situations ⇒  :

If the **MAX**  button or function button is pressed.

If the air distribution regulator of the manual air conditioning system is turned to  position.

 **WARNING**

Stale air can quickly make the driver tired and affect their concentration, which in turn can cause collisions, accidents and serious injuries.

Never use the air recirculation mode for an extended period as no fresh air will enter the vehicle interior.

If the cooling system is switched off, condensation can form on the windows very quickly in air recirculation mode and reduce visibility considerably.

Switch off the air recirculation mode when it is no longer required.

 **NOTICE**

In vehicles with an air conditioning system, do not smoke when the air recirculation mode is switched on. The smoke can leave a residue on the cooling system evaporator and the dust and pollen filter with pollution filter insert, producing a lasting unpleasant odour.



When reversing the vehicle, or when the wash and wipe system is being used, the air recirculation mode will switch on to prevent odours from entering the vehicle interior.

Climatronic



If the outside temperature is very high, the manual air recirculation mode can be activated for a short time to help cool the vehicle interior more quickly.



Seat heating



First read and observe the introductory information and safety warnings ⇒  Introduction

The seat cushions and backrests can be heated electrically when the engine is running.

Operating the seat heating

Press the  or  button in the air conditioning block in order to switch the seat heating to the highest temperature setting.

Press the  or  button repeatedly until the desired setting is reached.

To switch the seat heating off, press the  or  button repeatedly until no LEDs are lit.

If the ignition is turned on again within approximately 10 minutes, the most recent driver seat temperature setting is automatically activated.

When should I not switch on the seat heating?

Do not switch on the seat heating if one of the following conditions applies:

The seat is not occupied.

The seat is fitted with a protective cover.

A child seat is installed on the seat.

The seat cushion is damp or wet.

The temperature in the vehicle interior or the outside temperature is above +25°C (77°F).

 WARNING

Anyone with reduced sensitivity to pain or temperature due to medication, paralysis or chronic illness (e.g. diabetes) could sustain burns on the back, buttocks and legs when using the seat heating. These burns may take a long time to heal or may never heal fully. Please consult a doctor if you have questions about your own state of health.

Anyone with reduced sensitivity to pain or temperature should never use the seat heating.

 WARNING

Wet upholstery can cause a fault in the seat heating and increase the risk of burns.

Ensure that the seat cushion is dry before using the seat heating.

Do not sit on the seat in damp or wet clothing.

Do not place any damp or wet objects or items of clothing on the seat.

Do not spill any liquids on the seat.

 NOTICE

To avoid damaging the heating elements, do not kneel on the seats or apply sharp pressure at a single point to the seat cushion and backrest.

Liquids, sharp objects and insulating materials, such as a protective cover or child seat, may damage the seat heating.

If the system starts to produce an odour, switch off the seat heating immediately and have it checked by a qualified workshop.



To save fuel, switch the seat heating off as quickly as possible.

Steering wheel heating



First read and observe the introductory information and safety warnings ⇒ Introduction

The steering wheel heating works when the engine is running.

Switching the steering wheel heating on and off via the Infotainment system

Manual air conditioning system: press the **MENU** button on the Infotainment system and touch the Vehicle and function buttons.

Climatronic: open the air conditioning settings in the Infotainment system.

Touch the function button to switch the steering wheel heating on and off.

Switching the steering wheel heating on or off together with the seat heating (only for Climatronic)

Open the air conditioning settings in the Infotainment system.

Touch the function button.

Touch the Link seat/steering wheel heating function button to link the steering wheel heating with the seat heating.

Press the button to switch the steering wheel heating on or off together with the seat heating.

Selecting a temperature setting (only for Climatronic)

Open the air conditioning settings in the Infotainment system.

Touch the function button.

Touch the Setting function button to select a temperature setting.

Three temperature settings are available. The selected setting is saved when the ignition is switched off. The temperature setting for the steering wheel heating is unrelated to the temperature setting for the seat heating.

Switch-off conditions

The steering wheel heating will be switched off automatically if one of the following conditions is met:

Seat heating for the driver seat is switched off (if Link seat/steering wheel heating is active).

Power consumption is too high.

There is a fault in the steering wheel heating system.

Troubleshooting



First read and observe the introductory information and safety warnings ⇒ Introduction

The cooling system cannot be switched on or its function is restricted

The cooling system functions only when the engine is running and at ambient temperatures above +3°C (+38°F).

The cooling system is switched off when the engine is very warm.

Switch on the blower.

Check the fuse of the air conditioning system ⇒ Fuses in the dash panel .

Change the dust and pollen filter ⇒ Service .

If the fault persists, seek expert assistance.

The heating and fresh air system cannot be switched on or its function is restricted



The heating and defrost function are more effective when the engine is warm.

If the fault persists, seek expert assistance.

Condensation on the windows

Keep the air intake in front of the windscreen free of ice, snow or leaves in order to improve heating and cooling performance ⇒ Vehicle care .

Do not cover the air vents in the rear of the luggage compartment to allow air to flow through the vehicle from the front to the rear.

Press the  button or turn the rotary knob to  position in order to switch on the defrost function ⇒  .

The wrong unit of temperature is set

Change the unit of temperature for all temperature displays in the vehicle using the Infotainment system ⇒ Infotainment system controls and displays .

Change the unit of temperature in the instrument cluster menu ⇒ Instrument cluster .

Water under the vehicle

If the humidity and temperature outside the vehicle are high, condensation can drip off the evaporator of the cooling system and form a pool underneath the vehicle. This is normal and does not indicate a leak!

If the outside humidity is high and the outside temperature low, condensation may evaporate when the auxiliary heater is running ⇒ Auxiliary heater and ventilation . If this is the case, steam may appear underneath the vehicle. This is not a sign that the vehicle is damaged.

 **WARNING**

Poor visibility through all windows increases the risk of collisions and accidents, which can cause serious injuries.

Always ensure that all windows are free of ice, snow and mist to ensure good visibility.

Maximum heat output and the fastest possible defrosting of the windows are possible only when the engine is running. Do not start your journey until you have good visibility.

To help ensure good visibility, make sure that you use the air conditioning system and the rear window heating correctly.

Auxiliary heater and ventilation



Introduction

This chapter contains information on the following subjects:

⇒ Switching the auxiliary heater and ventilation on and off

⇒ Programming the auxiliary heater and ventilation

⇒ Remote control

The auxiliary heater and ventilation system can be used to heat the vehicle interior in the winter and ventilate it in the summer. It is able to clear ice, condensation and a thin layer of snow from the windscreen. The auxiliary heater is supplied with fuel from the vehicle fuel tank and can be operated when the vehicle is stationary with the ignition switched off. The auxiliary ventilation system is powered by the 12-volt vehicle battery.

Auxiliary heater exhaust system

The emissions generated by the auxiliary heater are discharged via an exhaust pipe underneath the vehicle. The exhaust pipe must not be blocked by snow, mud or other objects.



WARNING

Among other things, the emissions from the auxiliary heater contain carbon monoxide, which is an odourless and colourless poisonous gas. Carbon monoxide can cause people to lose consciousness. It can also cause death.

Never switch on the auxiliary heater when the vehicle is in unventilated or closed rooms nor let the auxiliary heater run in unventilated or closed rooms.

Never program the auxiliary heater so that it is switched on and runs in unventilated or closed rooms.



WARNING

Parts of the auxiliary heater exhaust system become very hot. This can cause fires.

Park the vehicle so that no part of the exhaust system can come into contact with any inflammable material underneath the vehicle, e.g. dry grass.

 NOTICE

Food, medicine and other items that are sensitive to heat or cold could be either damaged or rendered useless by the air flowing out of the vents.

Never leave food, medicines or other temperature-sensitive objects in front of the vents.

Switching the auxiliary heater and ventilation on and off



First read and observe the introductory information and safety warnings ⇒  Introduction

The auxiliary heater can be operated only when the ignition is switched off. If the ignition is switched on while the auxiliary heater is working, the auxiliary heater continues to run to provide additional heat.

Switching on the auxiliary heater

Press the  immediate heat button in the air conditioning block ⇒ Front controls .

OR: press the button on the remote control ⇒ Remote control .

OR: program the departure time ⇒ Programming the auxiliary heater and ventilation .

The auxiliary heater heats the vehicle interior to at least 22 °C.

The auxiliary heater will not switch on if the 12-volt vehicle battery is low or the fuel tank is empty.

Switching off the auxiliary heater manually

Press the  immediate heat button in the air conditioning block ⇒ Front controls .

OR: press the button on the remote control ⇒ Remote control .

OR: touch the  function button on the Infotainment system ⇒ Programming the auxiliary heater and ventilation .

Auxiliary heater switches off automatically

When the programmed departure time is reached, or after the programmed operating period has elapsed ⇒ Programming the auxiliary heater and ventilation .

When the indicator lamp  lights up (fuel gauge) ⇒ Fuel gauge .

If the charge level of the 12-volt vehicle battery is too low ⇒ 12-volt vehicle battery .

The auxiliary heater runs on for a short time after it has been switched off manually or automatically so that the remaining fuel in the system can be burnt off.



When the vehicle is at a standstill, the auxiliary heater can be activated up to three times in succession for the maximum operating duration.



Operating noises can be heard if the auxiliary heater is switched on.



The 12-volt vehicle battery will discharge if the auxiliary heating or ventilation is run several times over an extended period. Drive the vehicle for an appropriate distance in between in order to recharge the 12-volt vehicle battery.



The fuel gauge indication may not be accurate (just above the reserve quantity) when the vehicle is parked on a slope; this may restrict the function of the auxiliary heater.



The auxiliary heater may switch on automatically when the engine is started at temperatures below +5°C (+41°F) in order to provide additional heating power. The supplementary heating function will switch off again automatically after a short time.

Programming the auxiliary heater and ventilation



First read and observe the introductory information and safety warnings ⇒  Introduction

Opening the Auxiliary heater menu

The auxiliary heater is programmed in the Infotainment system.

Manual air conditioning system

Press the **MENU** button on the Infotainment system.

Touch the Vehicle and  function buttons.

Climatronic

Open the air conditioning settings in the Infotainment system.

Touch the  function button.

Changing operating mode

Open the Auxiliary heater menu.

Press the Heating or Ventilation function buttons to change mode.

At high outside temperatures, the auxiliary ventilation system directs fresh air into the vehicle and prevents the accumulation of heat.

Programming the auxiliary heater

Activation is always for one heating or ventilation operation only. The departure time must be activated again for every start.

Before programming, check that the date and time set in the vehicle are correct ⇒ Time .

Open the Auxiliary heater menu.

Touch the Set function button.

Select one of the memory locations for a Departure time.

Touch the Activate function button.

Manual air conditioning system: the programmed departure time determines the time at which the auxiliary heater or ventilation should switch off. The point at which the heating or ventilation process starts is determined depending on the programmed running time.

Climatronic: on the basis of the programmed departure time, the vehicle automatically calculates the start time for heating or ventilation to the currently set temperature depending on the outside temperature.

Press the Running time function button under Adjust in order to select the running time when the auxiliary heater is switched on using the immediate heat button  or remote control.

Checking programming

If a departure time has been activated, the LED in the immediate heat button  will light up on the Climatronic control panel for approximately 10 seconds after the ignition is switched off.

WARNING

Never program the auxiliary heating system so that is switched on and run in unventilated or enclosed spaces. Among other things, the emissions from the auxiliary heater contain carbon monoxide, which is an odourless and colourless poisonous gas. Carbon monoxide can cause people to lose consciousness. It can also cause death.

Remote control



Fig. 93 Auxiliary heater: remote control (left) with battery compartment (right).

 First read and observe the introductory information and safety warnings ⇒  Introduction

Switching the auxiliary heater on and off using the remote control

Switching on: press the  button ⇒ Fig. 93 .

The auxiliary heater is switched on when the LED on the remote control is lit up green.

Switching off: press the **OFF** button ⇒ Fig. 93 .

The auxiliary heater is switched off when the LED on the remote control is lit up red.

LED in the remote control

The LED ⇒ Fig. 93 ② provides feedback on various operating states when you press a button.

Lit up

greenThe auxiliary heater is switched on.
redThe auxiliary heater is switched off.

Flashing irregularly

greenAuxiliary heater disabled: the fuel tank is nearly empty, the 12-volt vehicle battery voltage is too low or a malfunction has occurred. Refuel and drive long enough to recharge the 12-volt vehicle battery or visit a qualified workshop.

Flashing regularly

red or greenSwitch-on or switch-off signal has not been received. Move closer to the vehicle.

Lit up or flashing

orangeThe button cell (battery) in the remote control is weak. Replace the button cell.

Range

The remote control has a range of a few hundred metres when the button cell is fully charged.

Maintain a distance of at least 2 metres between the remote control and the vehicle.

Avoid any obstacles between the remote control and the vehicle.

Hold the remote control with the aerial ⇒ Fig. 93 ① pointing vertically upwards.

Do not cover the aerial.

Adverse weather or a weak battery cell will significantly reduce the range.

Renewing the button cell in the remote control

The button cell in the remote control must be replaced if the indicator lamp does not light up.

Insert a suitable object, e.g. a screwdriver, in the recess on the side in the direction of the arrow ⇒ Fig. 93 .

Use the object to lever off the battery cover.

Slide the battery cover forwards slightly in the direction of the arrow.

Remove the battery cover.

Remove the button cell.

Insert a new button cell of the same type, paying attention to the correct polarity.

Insert the battery cover into the remote control housing.

Slide the battery cover in the opposite direction of the arrow ⇒ Fig. 93 until it clicks into place.



Swallowing batteries with a diameter of 20 mm or other button cells can result in serious or even fatal injuries within a very short period of time.

Always keep the remote control key, key ring with batteries, spare batteries, button cells and other batteries that are larger than 20 mm out of the reach of children.

Call for medical help immediately you suspect that someone has swallowed a battery.



The remote control contains electronic components. For this reason, protect the remote control from moisture, excessive vibration and direct sunlight.

Unsuitable batteries can damage the remote control. Replace discharged batteries only with new batteries of the same voltage rating, size and specification.

Make sure the polarity is correct when inserting the battery.



Dispose of discharged batteries in accordance with environmental regulations.



The battery in the remote control may contain perchlorate. Observe the applicable legislation regarding disposal.

Driving

Notes on driving

Pedals

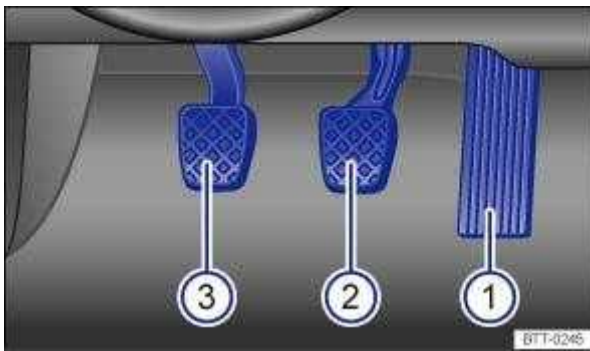

Fig. 94 In the footwell: pedals in vehicles with a manual gearbox.

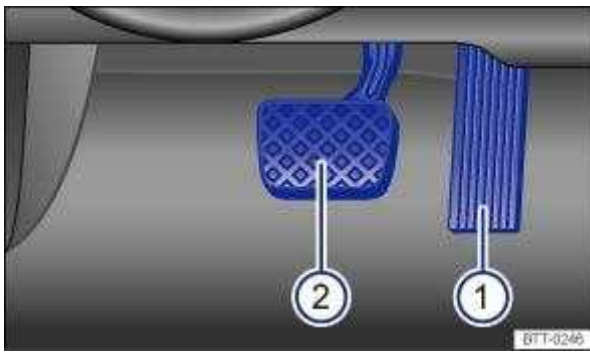

Fig. 95 In the footwell: pedals in vehicles with a dual clutch gearbox.

Key to ⇒ Fig. 94 and ⇒ Fig. 95 :

- ① Accelerator
- ② Brake pedal
- ③ Vehicles with manual gearbox: clutch pedal

The operation and freedom of movement of all pedals must never be impaired by objects or floor mats.

Use only floor mats that leave the pedal area free and can be securely fastened in the footwell so that they do not slip.

⚠ WARNING

Objects in the driver footwell can interfere with pedal operation. This can lead to loss of control of the vehicle and increase the risk of serious injury.

Make sure that all pedals can always be operated without any interference.

The floor mats must always be properly secured in the footwell.

Never place additional floor mats or other floor coverings over the fitted floor mat.

Make sure that no objects can enter the driver footwell while the vehicle is in motion.

If there are any objects in the footwell, remove them when the vehicle is parked.

 NOTICE

Free access to the pedals must be ensured at all times. For example, a larger brake pedal travel will be necessary in order to stop the vehicle if a brake circuit fails. The brake pedal will have to be depressed further and harder than normal.

Gear-change indicator

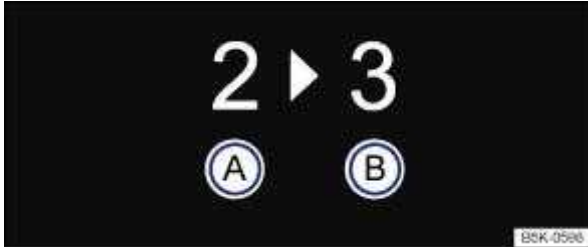



Fig. 96 On the instrument cluster display: gear-change indicator.

Key to ⇒ Fig. 96 :

 A Currently selected gear.

 B Recommended gear.

Depending on the vehicle's equipment level, the instrument cluster display may indicate a gear which should be selected to reduce fuel consumption while the vehicle is in motion.

Vehicles with DSG dual clutch gearbox: the selector lever must be in the Tiptronic position for this ⇒ Changing gear using Tiptronic .

No recommended gear is indicated if the most suitable gear is already selected. The currently selected gear is displayed.

Information on cleaning the particulate filter

The engine management system recognises when the particulate filter is becoming saturated and supports regeneration of the filter by recommending the most suitable gear when driving. Compared with normal driving, this may mean driving with an increased engine speed ⇒ Particulate filter .

 CAUTION

The gear-change indicator is designed only to assist the driver and cannot replace the driver's own judgement.

The driver has full responsibility for selecting the correct gear in all situations, e.g. when overtaking or when driving up and down hills.



Driving in the correct gear can help to reduce fuel consumption.



The gear-change indicator display goes out when the clutch is depressed in vehicles with a manual gearbox or when Tiptronic position is deselected in vehicles with a DSG® dual clutch gearbox.

Driving economically

Fuel consumption, environmental impact and wear of the engine, brakes and tyres can be reduced by adopting the correct driving style. A few tips are provided below which will help you protect the environment and also save money.

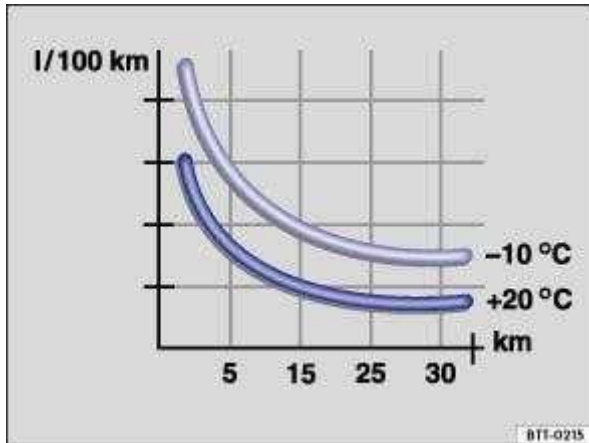

Fig. 97 Fuel consumption in l/100 km at two different ambient temperatures.

Think ahead when driving

The fuel consumption will increase if you do not adopt a steady driving style. Keeping a close eye on the traffic can help to avoid frequent acceleration and braking. Keeping a sufficient distance from the vehicle in front will help you to think ahead when driving.

With a gear engaged, allow the vehicle to come to a halt by itself to make use of the engine braking effect, e.g. when approaching traffic lights.

Use coasting

Vehicles with a DSG dual clutch gearbox: when the selector lever is in position D and neither the accelerator nor the brake pedal is depressed, the vehicle will roll (coast) with practically no energy being consumed.

Change gears in an energy-saving way

Shifting up early at an engine speed of 2,000 rpm will save energy. Do not drive gears to the limit and avoid high revs.

Vehicles with manual gearbox: change from first to second gear immediately after setting off.

Vehicles with DSG dual clutch gearbox: accelerate slowly and avoid using the kickdown function.

Gear-change indicator ⇒ Gear-change indicator .

Eco driving profile ⇒ Driving profile selection and 4MOTION Active Control .

Avoid driving at full throttle

Never drive the vehicle at its top speed. The drag coefficient increases at excessively high speeds. This in turn increases the force needed to move the vehicle.

Reduce idling

Pull away immediately with low engine speeds. If you are stopped for a long period, do not allow the engine to idle but switch it off, e.g. when in a traffic jam or at a railway crossing.

In vehicles with an activated start/stop system, the engine can switch off automatically when the vehicle is stopping and when the vehicle is stationary ⇒ Start/stop system .

Refuel moderately

A full fuel tank increases the weight of the vehicle. A fuel tank that is half or two thirds of the way full is sufficient for journeys in urban traffic in particular.

Avoid short journeys

A cold engine has very high fuel consumption. The optimum operating temperature is reached only after driving a few kilometres. The fuel consumption is above average at very low ambient temperatures, e.g. in winter ⇒ Fig. 97 . Plan journeys economically and combine short journeys.

Carry out regular maintenance

Regular maintenance is an essential prerequisite for economical driving and increases the service life of the vehicle.

Observe the tyre pressures

Low tyre pressures does not just mean greater wear, but also increase the rolling resistance of the tyres and thus the fuel consumption. Use optimised rolling resistance tyres.

Adjust the tyre pressure according to the load. Observe the information on the tyre pressure sticker ⇒ Useful information about wheels and tyres

Tyre Pressure Loss Indicator or Tyre Pressure Monitoring System ⇒ Tyre monitoring system .

Use low viscosity engine oils

Fully synthetic engine oils with a low viscosity decrease frictional resistance in the engine and are distributed better and more quickly, especially during cold starts.

Do not drive with unnecessary loads in the vehicle

You can reduce fuel consumption by clearing out the luggage compartment before setting off, for example by removing empty drink crates or unused child seats.

To keep the vehicle's air resistance as low as possible, remove any add-on parts and equipment such as ski racks, bicycle racks and roof carriers once you have finished using them.

Save electrical energy

The alternator is driven by the engine and generates electrical power for convenience consumers such as the air conditioning system, windscreen heating and ventilation. Saving electrical energy is easy, e.g.:

Open the windows and doors before driving at high outside temperatures and drive for a short distance with a window open. Only then switch the air conditioning system on.

Switch the convenience consumers off as soon as they have served their purpose.

 **WARNING**

Adapt your speed and distance from the vehicles ahead to suit visibility, weather, road and traffic conditions.



Inform yourself about other ways of protecting the environment. Think Blue. is the global Volkswagen trademark for sustainability and environmental compatibility.



Your Volkswagen dealership can provide you with further information on maintenance and energy-efficient replacement parts, e.g. new tyres.

Think Blue. Trainer.

The Think Blue. Trainer analyses and visualises your driving style and helps you to drive more economically.

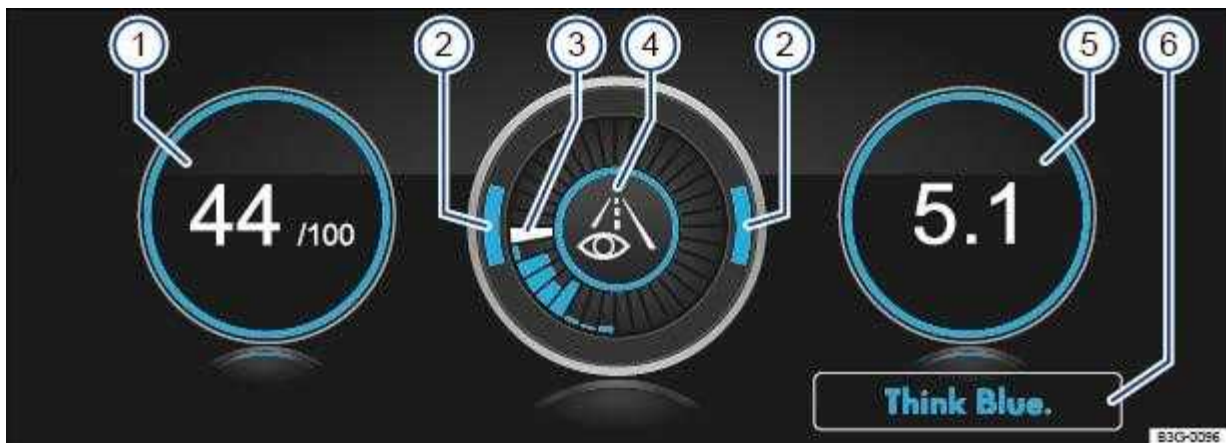

Fig. 98 In the Infotainment system: Think Blue. Trainer.

Key to ⇒ Fig. 98 :



Blue Score:

The higher the displayed value on a scale from 0 to 100, the more efficient your driving style. A blue border symbolises an efficient and constant driving style. A grey border indicates an inefficient driving style.

Touch the display to open the statistics of the last 30 driving minutes Since start.

2

Acceleration and braking:

At a constant speed, two arcs appear in the central area. The arcs move up and down during acceleration and braking.

3

Progress display:

The efficiency of the driving style is indicated by the blue bars. The white bar stores a blue bar approximately every five seconds.

The larger the bar, the more efficient the driving style has been.

4

Driving tips:



Think ahead when driving.



Gear-change indicator.



Adapt your speed.



Economical driving style.

5

Fuel consumption:

The display shows the average fuel consumption Since start in l/100 km. A blue border symbolises an efficient and constant driving style. A grey border indicates an inefficient driving style.

Touch the display to open the statistics of the last 30 driving minutes Since start.

6

Tips for saving energy:

Touch the Think Blue. function button to access additional tips.

Opening the Think Blue. Trainer.

Press the **MENU** button or function button on the Infotainment system according to the equipment level.

Touch the function buttons Vehicle, Selection, Think Blue. Trainer..



WARNING

Accidents and injuries can occur if the driver is distracted. Operating the Infotainment system can distract you from the road.

Always drive carefully and responsibly.

Information on the brakes

New brake pads cannot generate the full braking effect during the first 200 to 300 km and must first be run in ⇒ . The slightly reduced brake pressure can however be compensated for by increasing pressure on the brake pedal. During the run-in period, the braking distance is longer for full or emergency braking than when the brake pads have been run in. In the run-in period, full braking should be avoided and also situations that create a heavy load on the brakes, e.g. when driving up close to the vehicle ahead.

The wear of the brake pads depends to a great extent on the conditions under which the vehicle is operated and the way the vehicle is driven. If the vehicle is used for regular urban trips, short journeys, and is driven with a sporty driving style, the brake pads must be regularly checked by a qualified workshop.

When driving with wet brakes, for example after driving through water, after heavy rainfall or after washing the vehicle, the braking effect may be delayed as the brake discs will be wet, or possibly iced up (in winter). The brakes must be dried as quickly as possible by careful braking at higher speed. Please ensure that no following vehicle and no other road user is put at risk as a result of this action ⇒ .

A layer of salt that accumulates on the discs and pads will reduce the braking effect and increase the braking distance. If the vehicle has not been braked for a long time on roads which have been gritted with salt, the layer of salt must be reduced through careful braking ⇒ .

Corrosion on the brake discs and dirt in the brake pads are facilitated through long standstill times, low mileage and low load levels. If the brake pads have been hardly used or if they are corroded, Volkswagen recommends that the brake discs and brake pads be cleaned by braking strongly several times from high speed. Please ensure that no following vehicle and no other road user is put at risk as a result of this action ⇒ .

Brake servo

The brake servo will function only when the engine is running and reinforces the pressure applied by the driver on the brake pedal.

If the brake servo does not function or the vehicle is being towed, the brake pedal will have to be depressed more forcefully as the braking distance will be increased due to the lack of assistance for the brake system ⇒ .

WARNING

Driving with worn brake pads or with a faulty brake system can cause accidents and serious injuries.

If the warning lamp  lights up either alone or together with a text message in the instrument cluster display, go to a qualified workshop immediately to have the brake pads checked and the worn brake pads replaced.

 WARNING

New brake pads will not have the optimal braking effect when first fitted.

New brake pads cannot generate the full braking effect during the first 300 km and must first be run in. A reduced braking effect can be increased by applying more pressure to the brake pedal.

In order to reduce the risk of accidents, serious injuries and the loss of control over the vehicle, you must drive particularly carefully when driving with new brake pads.

Never drive too close to other vehicles during the run-in time for the new brake pads and never create a driving situation that will place a heavy load on the brakes.

 WARNING

Overheated brakes reduce the braking effect and considerably increase the braking distance.

When driving downhill, the brakes are placed under particular strain and become hot very quickly.

Before driving down a long, steep gradient, reduce speed and change to a lower gear (with manual gearboxes or in Tiptronic mode with the automatic gearbox). This will make use of the engine braking effect and relieve the load on the brakes.

Non-standard or damaged front spoilers could restrict the airflow to the brakes and cause them to overheat.

 WARNING

Wet brakes or brakes coated with ice or road salt react more slowly and require longer braking distances.

Carefully apply the brakes to test them.

Always dry brakes and clean off any coating of ice and salt with a few cautious applications of the brake when visibility, weather, road and traffic conditions permit.

 WARNING

Driving without the brake servo can considerably increase the braking distance and thus cause accidents and serious injuries.

Never switch the engine or ignition off while the vehicle is in motion.

If the brake servo does not function or the vehicle is being towed, the brake pedal will have to be depressed more forcefully as the braking distance will be increased due to the lack of assistance for the brake system.



If the front brake pads are checked, the rear brake pads should be checked at the same time. A visual check of the thickness of all brake pads should be carried out regularly by checking the brake pads through the openings in the rims or from the underside of the vehicle. If necessary, remove the wheels to carry out a comprehensive check. Volkswagen recommends using a Volkswagen dealership for this purpose.

Driving a loaded vehicle

For good vehicle handling when driving a loaded vehicle, please observe the following:

Stow all items of luggage securely ⇒ Stowing luggage and loads .

Accelerate particularly cautiously and carefully.

Avoid sudden braking and driving manoeuvres.

Brake earlier than in normal driving.

If applicable, observe the information concerning the roof carrier ⇒ Roof carrier .

WARNING

Moving loads can severely impair the vehicle's stability and driving safety which could cause accidents and serious injuries.

Secure items properly so they cannot slide about.

Use suitable lashing or securing straps when securing heavy objects.

Securely engage the rear seat backrests.

Driving with an open boot lid

Driving with an open boot lid is particularly dangerous. All objects and the open boot lid must be secured properly. Take the appropriate measures to reduce the amount of poisonous exhaust fumes that could enter into the vehicle.

WARNING

Driving with an unlocked or open boot lid can cause serious injuries.

Always drive with the boot lid closed.

Always stow all items in the luggage compartment securely. Loose objects can fall out of the luggage compartment and injure other road users.

Always drive especially carefully and think ahead.

Avoid any abrupt or sudden driving and braking manoeuvres as this could cause the open boot lid to move unpredictably.

Any objects protruding from the luggage compartment must be marked to ensure that they are visible to other road users. Comply with legal regulations.

If items protrude out of the luggage compartment, never use the boot lid to wedge them into place or hold them in position.

If you have to drive with the boot lid open, you must remove any carriers and the loads attached to them from the boot lid.

 **WARNING**

Poisonous exhaust fumes could enter the vehicle interior when the boot lid is open. This could result in loss of consciousness, carbon monoxide poisoning, serious injury and accidents.

You should always drive with the boot lid closed in order to prevent poisonous exhaust fumes from entering the vehicle.

If exceptional circumstances require you to drive with an open boot lid, you must do the following to reduce the amount of poisonous exhaust fumes that could enter into the vehicle:

Close all windows and the glass roof.

Switch off the air recirculation mode of the heating and fresh air system or air conditioning system.

Open all vents in the dash panel.

Switch the blower for the heating and fresh air system or for the air conditioning system to the highest setting.

 **NOTICE**

The vehicle height, and possibly the length, are different when the boot lid is open.

Driving through water

Please follow these points in order to prevent damage to your vehicle when driving through water, for example on flooded streets:

Check how deep the water is before driving through it. The water may be no higher than the lower edge of the body ⇒  .

Do not drive faster than walking speed.

Never stop the vehicle, reverse or switch off the engine while in water.

Oncoming vehicles will create waves that could increase the water level for your vehicle to such an extent that it is not safe to drive through the water.

Always deactivate the start/stop system manually when driving through water ⇒ Start/stop system .

 WARNING

After driving through water, mud, slush etc., the brakes may react slowly and the braking distance will be increased as the brake discs and pads will be wet, or possibly iced up in winter.

Dry and de-ice the brakes using careful braking manoeuvres. Make sure that you do not endanger any other road users or violate any legal regulations when doing so.

Avoid abrupt and sudden braking manoeuvres directly after driving through water.

 NOTICE

If you drive through water, parts of the vehicle, such as the engine, gearbox, running gear and vehicle electrics, could sustain severe damage.

Never drive through salt water as salt can cause corrosion. Immediately rinse all components that have been exposed to salt water with fresh water.

Running in the engine

A new engine has to be run in during the first 1,500 kilometres. This enables all the moving parts to bed in together. During the first few operating hours, the engine has higher internal friction than it does later.

Do not depress the accelerator fully.

Do not drive the vehicle at more than 2/3 of the maximum engine speed.

Gradually increase speed and engine speed.

The style of driving during the first 1,500 kilometres will also affect the engine quality. Even after this time – and especially with a cold engine – drive the vehicle at moderate engine speeds in order to reduce engine wear and to increase the mileage that the engine can cover.

Do not drive at engine speeds which are too low. Always shift down gear if the engine is not running smoothly.

New tyres ⇒ Wheels and tyres and brake pads ⇒ Notes on driving must be run in carefully.



If the engine is run in gently, its life will be increased and its oil consumption reduced.

Using the vehicle in other countries and continents

The vehicle is produced at the factory specifically for a certain country and complies with this country's registration regulations valid at the time of vehicle production.

If you want to use the vehicle abroad temporarily or for a short period, all relevant information and instructions should be followed ⇒ Safety .

If the vehicle is going to be sold in another country or used in another country for an extended period, the legal requirements applicable in that country must be observed.

In some cases, certain equipment will have to be fitted or removed and functions deactivated. The scope of services and service types could also be affected. This is particularly important if the vehicle is driven in another climate region for a long period of time.

Because different frequency bands are used in different countries, the factory-fitted Infotainment system may not work in other countries.

NOTICE

Volkswagen is not responsible for any vehicle damage caused by low-quality fuel, inadequate servicing work or non-availability of Genuine Parts.

Volkswagen cannot be held responsible if the vehicle does not comply with or only partly complies with the relevant legal requirements in other countries and continents.

Troubleshooting

Unusual braking behaviour

The warning lamp lights up red.

A text message may also be displayed.

The vehicle does not brake in the usual way or the braking distance is longer than normal.

There is a malfunction in the brake system.

Go to the nearest qualified workshop without delay.

Drive at low speed and be prepared for longer braking distances and the need to apply increased pedal pressure.

Brake pad wear indicator

The indicator lamp lights up yellow.

Front brake pads are worn.

Go to a qualified workshop immediately.

All brake pads should be checked and renewed as necessary.

Starting and stopping the engine



Ignition lock



Fig. 99 To the right of the steering wheel: positions of the vehicle key in the ignition lock.

When there is no vehicle key in the ignition lock, the steering column lock may be activated.

Vehicle key positions ⇒ Fig. 99

- ① Ignition switched off. The vehicle key can be removed.
- ① Ignition switched on. Steering lock can be released. The diesel engine is pre-heated and the indicator lamp  lights up yellow.
- ② Depress the brake pedal when the indicator lamp  lights up green. Start the engine. Release the vehicle key as soon as the engine starts. Once released, the vehicle key moves back to position ⇒ Fig. 99 ① .

Ignition switched on warning

A warning message appears in the instrument cluster display if the driver door is opened while the ignition is switched on. A signal tone may also be given.

The warning is a reminder that the ignition must be switched off before leaving the vehicle.

WARNING

Improper or unsupervised use of the vehicle keys can cause accidents or serious injuries.

Always take all vehicle keys with you every time you leave the vehicle. The engine can be started and electrical equipment such as the window controls can be operated. This can cause serious injury.

Never leave children or people requiring assistance alone in the vehicle when the vehicle is locked. They could become trapped in the vehicle in an emergency and may not be able to get themselves to safety. For example, locked vehicles may be subjected to very high or very low temperatures depending on the season. This can cause serious injuries and illness or fatalities, especially in the case of small children.

Never remove the vehicle key from the ignition if the vehicle is in motion. The steering column lock may be activated and you will no longer be able to steer the vehicle.

The key bit in the vehicle key must be folded out fully and locked in position.

Only attach light objects weighing less than 100 g to the vehicle key.

NOTICE

The 12-volt battery may be discharged unintentionally and prevent the engine from restarting if the ignition is switched on while the engine is switched off.

Always switch off the ignition before you leave the vehicle.



For vehicles with DSG dual clutch gearbox in some markets: if the vehicle key cannot be removed from the ignition lock when the vehicle is stopped, move the selector lever to P. If necessary, press the lock button in the selector lever and then release it.

Starter button

The starter button replaces the ignition lock (Press & Drive).



Fig. 100 In the lower section of the centre console: starter button for starting the engine.

The starter button is used to start the vehicle (Press & Drive).

The vehicle can be activated only if there is a valid vehicle key in the vehicle.

When leaving the vehicle, the electronic steering column lock will be activated when the ignition is switched off and the driver door is opened ⇒ Steering .

Switching the ignition on and off

Press the starter button once without depressing the brake or clutch pedal ⇒  .

Automatic ignition switch-off

The ignition switches off automatically after a short time if the driver moves away from the vehicle with the vehicle key when the ignition is switched on. If the dipped beam headlights were switched on at the time, the side lights will remain switched on for approximately 30 minutes. The side lights can be switched off manually or by locking the vehicle ⇒ Lights .

Automatic ignition switch-off in vehicles with a start/stop system

When all the following conditions are fulfilled at the same time, the vehicle ignition will be switched off automatically when engine stop is active when the vehicle is stationary:

The driver seat belt has been unfastened.

No pedals are depressed.

The driver door is opened.

If the ignition is deactivated automatically while the dipped beam headlights  are switched on, the side lights remain switched on and lit for approximately 30 minutes.

The side lights can be switched off manually or will go off when the vehicle is locked.

Engine restart function

If no valid vehicle key is detected in the vehicle interior once the engine has been switched off, the engine can be restarted within approximately five seconds. A corresponding message appears on the instrument cluster display.

After this time, the engine cannot be re-started without a valid vehicle key in the vehicle interior.

 **WARNING**

Unintentional vehicle movements can cause serious injury.

Do not depress the brake or clutch pedal when the ignition is switched on as the engine will start immediately.

 **WARNING**

Improper or unsupervised use of the vehicle keys can cause accidents or serious injuries.

Always take all vehicle keys with you every time you leave the vehicle. Children or unauthorised persons could lock the vehicle, start the engine, switch on the ignition or operate electrical equipment such as the electric windows.



Before leaving the vehicle, always switch off the ignition manually and observe any information shown on the instrument cluster display.



Leaving the vehicle stationary for long periods with the ignition switched on can discharge the 12-volt vehicle battery so that the engine can no longer be started.

Starting the engine

Vehicles with ignition lock: turn the vehicle key to position ⇒ Fig. 99 ① . The ignition is switched on.

Vehicles with a starter button: press the starter button once. The ignition is switched on.

Vehicles with a diesel engine: during the diesel engine preheating phase, the indicator lamp  lights up in the instrument cluster.

Depress and hold the brake pedal until the electronic parking brake has been switched off.

Vehicles with manual gearbox: fully depress the clutch pedal and hold it until the engine has been started. Move the gear lever to neutral position.

Vehicles with DSG dual clutch gearbox: move the selector lever to position P or N.

Vehicles with ignition lock: turn the vehicle key to position ⇒ Fig. 99 ② – do not depress the accelerator.

Release the vehicle key once the engine has started.

Vehicles with a starter button: press the starter button ⇒ Starter button – do not depress the accelerator. There must be a valid vehicle key in the vehicle before the engine can be started.

If the engine does not start immediately, switch off the starter and try again after about a minute.

Vehicles with starter button: perform an emergency start if necessary ⇒ No valid vehicle key recognised .

Vehicles with starter button: the starter button is deactivated if the vehicle was locked with the vehicle key. If you are in the vehicle and need to start the engine, unlock the vehicle first or perform an emergency start ⇒ No valid vehicle key recognised .

Switch off the electronic parking brake if you wish to pull away.

 **WARNING**

The risk of serious injury can be reduced with the engine running or when starting the engine.

Never start or run the engine in unventilated or enclosed spaces. The exhaust fumes contain carbon monoxide, an odourless and colourless toxic gas. Carbon monoxide can cause people to lose consciousness. It can also cause death.

Never start or run the engine if oil, fuel or any other highly flammable fluids are under or near the vehicle, or are leaking out of the vehicle, e.g. as the result of damage.

Never leave the vehicle unattended with the engine running, particularly if a gear or driving position has been selected. The vehicle could move suddenly or something unexpected may happen that may cause damage, fire and serious injuries.

Never use a start booster. Start boosters could explode and cause the engine to suddenly run at high revs.

 WARNING

Never leave the engine running if you leave the vehicle unattended, particularly if a gear or position has been selected. The vehicle could move suddenly or something unexpected may happen that may cause damage, fire or serious injuries.

 WARNING

Start boosters could explode or cause the engine to suddenly run at high revs.

Never use a start booster.

 NOTICE

The starter and the engine can be damaged if you attempt to start the engine while the vehicle is in motion or if the engine is started again immediately after it has been switched off.

When the engine is cold, avoid high engine speeds, driving at full throttle and overloading the engine.

Do not push start or tow start the vehicle. Unburnt fuel could damage the catalytic converter.

 NOTICE

If the engine does not start, never use the starter with a gear selected and the vehicle key in the ignition lock in position ⇒ Fig. 99② for driving or tow-starting, e.g. when the fuel tank is empty. This could cause damage to the starter.

Fill up with fuel if necessary ⇒ Fuel types and refuelling or jump start the vehicle ⇒ Jump starting .

If the engine does not start, seek expert assistance.



Do not warm up the engine by running it while the vehicle is stationary. Instead, pull off as soon as there is good visibility through the windows. This helps the engine reach operating temperature faster and reduces emissions.



Components with a high power consumption are switched off temporarily when the engine is started.



The engine cannot be started with the starter button, for example, if the button cell in the vehicle key is weak or flat. In this case, use the emergency start function ⇒ No valid vehicle key recognised .



When starting from cold, the engine may be a little noisy for the first few seconds. This is quite normal, and no cause for concern.



At outside temperatures of less than +5°C (+41°F), fumes may be detected under a vehicle with a diesel engine if the fuel-powered supplementary heater is switched on.

Switching off the engine

Bring the vehicle to a standstill ⇒  .

Park the vehicle ⇒ Parking .

Vehicles with ignition lock: turn the vehicle key to position ⇒ Fig. 99  in the ignition lock.

Vehicles with a starter button: press the starter button briefly ⇒ Fig. 100 . If the engine cannot be switched off, carry out the emergency switch-off procedure ⇒ Engine cannot be switched off .

Follow the instructions in the instrument cluster ⇒ Instrument cluster .

Ignition warning

In order to indicate an active ignition when leaving the vehicle, an acoustic warning signal sounds when opening the driver door and corresponding warning messages appear on the display of the instrument cluster.

Warning before leaving the vehicle

Vehicles with DSG dual clutch gearbox: if the selector lever is not in position P, an acoustic warning signal will sound when the driver door is opened and the warning message Please move selector lever to position P. will be shown on the instrument cluster display. In this way, a warning is given that the vehicle could potentially roll away. When you leave the vehicle, the electronic parking brake also switches on to prevent the vehicle rolling away.



Never switch off the engine while the vehicle is in motion. This can lead to a loss of vehicle control, accidents and serious injuries.

The airbags and belt tensioners will not work if the ignition is switched off.

The brake servo will not work when the engine is switched off. More force is required on the brake pedal to stop the vehicle.

If the vehicle key is removed from the ignition, the steering lock may activate and you will no longer be able to steer the vehicle.

 **WARNING**

The components of the exhaust system become very hot. This can cause fires and serious injuries.

Never park the vehicle so that parts of the exhaust system can come into contact with any inflammable material underneath the vehicle, e.g. undergrowth, leaves, dry grass, spilt fuel etc.

Never apply additional underseal or anti-corrosion coatings to the exhaust pipes, catalytic converters, heat shields or particulate filter.

 **NOTICE**

If the vehicle has been driven at high load for a long period, the engine can overheat when it is switched off. In order to avoid damage to the engine, allow the engine to run in neutral position for approximately 2 minutes before switching it off.



After the engine is switched off, the radiator fan in the engine compartment may run on for some minutes, even if the ignition is switched off or the vehicle key has been removed. The radiator fan will switch itself off automatically.

Electronic immobiliser

The immobiliser helps to prevent the engine from being started and driven with an unauthorised vehicle key.

There is a chip in the vehicle key. The immobiliser is automatically deactivated by this when a valid vehicle key is inserted in the ignition lock.

The electronic immobiliser is automatically activated when the vehicle key is removed from the ignition lock. In vehicles with Keyless Access, the vehicle key must be outside the vehicle.

The engine can be started only using a Volkswagen Genuine vehicle key with the correct code. Coded vehicle keys are available from a Volkswagen dealership.



Problem-free operation of the vehicle is guaranteed only with Volkswagen Genuine vehicle keys.

Troubleshooting

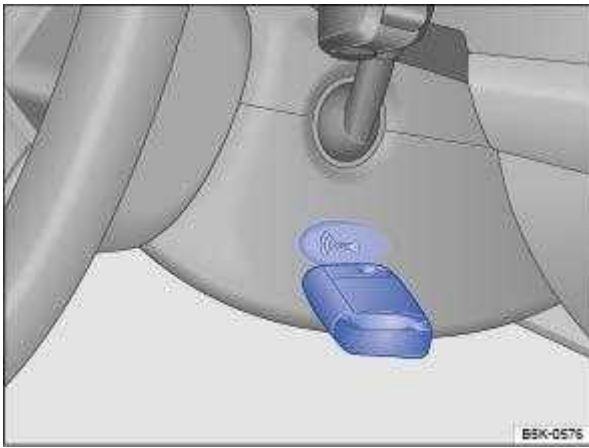

Fig. 101 On the right-hand side of the steering column: emergency start function in vehicles with the keyless locking and starting system Keyless Access.

EPC Fault in engine management system

The indicator lamp lights up yellow.

Fault in the engine management system.

The engine should be checked by a qualified workshop as soon as possible.

! Engine speed limited

The indicator lamp lights up yellow.

The engine speed was limited to prevent the engine from overheating.

The engine speed is shown on the instrument cluster display.

The engine speed limitation will be cancelled again in the following cases:

Engine is no longer in a critical temperature range.

Foot is taken off the accelerator.

! together with **EPC** engine speed limitation due to fault in the engine management system

The indicator lamps light up yellow.

Engine speed limitation is activated due to a fault in the engine management system.

Make sure that the displayed engine speed is not exceeded.

The engine should be checked by a qualified workshop as soon as possible.

⊘ Glow plug system/engine management system

Vehicles with diesel engine:

The indicator lamp lights up yellow.

When the diesel engine is being pre-heated, the indicator lamp lights up in the instrument cluster for a few seconds.

The indicator lamp flashes yellow.

There is a fault in the engine management system.

The engine should be checked by a qualified workshop as soon as possible.

Vehicle key cannot be removed from the ignition lock

An unauthorised vehicle key has been inserted in the ignition lock.

Remove the vehicle key as follows:

Vehicles with DSG dual clutch gearbox

Press the lock button in the selector lever and release.

Remove the vehicle key from the ignition lock.

Vehicles with a manual gearbox

Remove the vehicle key from the ignition lock.

No valid vehicle key recognised

A corresponding display will appear in the instrument cluster.

If the button cell in the vehicle key is weak or discharged, it is possible that the vehicle key will not be recognised.

In this case, you will need to perform an emergency start:

Depress and hold the brake pedal.

Hold the vehicle key to the right of the steering column trim directly after pressing the starter button
⇒ Fig. 101 .

The ignition is switched on automatically, and in some cases the engine is started.

Engine cannot be switched off

The engine cannot be switched off by briefly pressing the starter button.

In this case it is necessary to perform an emergency switch-off procedure:

Press the starter button twice within a few seconds or press and hold once.

The engine will switch off automatically ⇒  .

Engine cannot be started

A corresponding message will be displayed in the instrument cluster if an unauthorised vehicle key is used or there is a system fault.

Use an authorised vehicle key.

If the problem persists, seek expert assistance.

Start/stop system

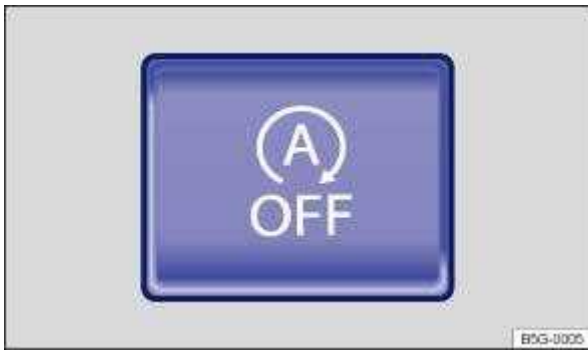

Fig. 102 In the upper part of the centre console: button for the start/stop system.

The start/stop system automatically switches the engine off when the vehicle is coming to a stop and when stationary. When required, the engine restarts automatically.

Switching on the start/stop system

The function is automatically activated every time the ignition is switched on. The instrument cluster display will show information about the current status.

Further information on start/stop mode can be accessed in the Infotainment system using the **MENU** button or function button and the Vehicle, Selection, Vehicle status function buttons. This information also applies to coasting.

Always switch off the start/stop system manually when driving through water.

Indicator lamps

If the indicator lamp  lights up, the start/stop system is available and automatic engine stop is active.

If the indicator lamp  lights up, the start/stop system is not available or the start/stop system has started the engine automatically ⇒ Conditions for an automatic restart .

The display on the instrument cluster may show the status of the start/stop system.

In addition, start/stop information on the current status of the start/stop system can be displayed as required in Infotainment systems with a navigation function. Touch the **i** in the start/stop information to obtain further information on the status.

Vehicles with a manual gearbox

Disengage the gear and release the clutch pedal when the vehicle is coming to a stop, or when it is stationary. The engine is stopped.

Depress the clutch pedal to restart the engine.

Important preconditions for automatic engine switch-off

The driver is wearing their seat belt.

The driver door is closed.

The bonnet is closed.

A minimum engine temperature has been reached.

Vehicles with Climatronic: the temperature of the vehicle interior is within the preset temperature range, and the humidity level is not too high.

The defrost function of the air conditioning system is not switched on.

The charge level of the 12-volt vehicle battery is sufficient.

The temperature of the 12-volt vehicle battery is not too low or too high.

The vehicle is not on a steep uphill or downhill gradient.

Vehicles with DSG dual clutch gearbox: the steering wheel is not turned too sharply.

The windscreen heating is not switched on.

Reverse gear is not engaged.

Park Assist is not active.

When the conditions for automatic engine switch-off are fulfilled only during a stationary phase, the engine can also switch off subsequently, e.g. after switching off the defrost function.

Conditions for an automatic restart

The engine can start automatically under the following conditions:

If the temperature inside the vehicle substantially increases or decreases.

If the vehicle starts rolling.

If the electrical voltage of the 12-volt vehicle battery drops.

If the steering wheel is moved.

As a general rule, the engine always starts again automatically when required by the detected situation and for the vehicle.

Conditions that require a manual engine start

The engine must be started manually in the following conditions:

If the driver door is opened.

If the bonnet is opened.

Manually deactivating and activating the start/stop system

Press the  button in the centre console ⇒ Fig. 102 to deactivate the system manually. If the start/stop system has been deactivated, the indicator lamp in the button lights up.

Press the  button in the centre console again ⇒ Fig. 102 to activate the system manually once more.

The instrument cluster shows the status of the start/stop system each time the  button is pressed.

If the start/stop system has switched the engine off, it will start again as soon as the system is deactivated manually with the  button.

Always deactivate the start/stop system manually when driving through water.

Start/stop mode when Adaptive Cruise Control (ACC) is active

The engine will be switched off after the Adaptive Cruise Control (ACC) has brought the vehicle to a standstill via an active braking intervention ⇒ Adaptive Cruise Control (ACC) .

The engine will be switched off after the Adaptive Cruise Control (ACC) has brought the vehicle to a standstill via an active braking intervention ⇒ Adaptive Cruise Control (ACC) .

Vehicles with dual clutch gearbox DSG: when adaptive cruise control (ACC) is activated, the dual clutch gearbox DSG® can switch to coasting mode.

Vehicles with dual clutch gearbox DSG: when adaptive cruise control (ACC) is activated, the dual clutch gearbox DSG® can switch to coasting mode.

In the following instances, the engine will restart when the Adaptive Cruise Control (ACC) is active:

If the accelerator is depressed.

When the Adaptive Cruise Control (ACC) has resumed speed and distance control.

If the vehicle ahead has moved on.

WARNING

Never switch off the engine or the ignition while the vehicle is in motion. This can lead to a loss of vehicle control, accidents and serious injuries.

The airbags and belt tensioners will not work if the ignition is switched off.

The brake servo will not work when the engine is switched off. That is why more pressure on the brake pedal is needed to brake the vehicle when the engine is switched off.

The power steering will not work when the engine is not running. More power is needed to steer the vehicle when the engine is switched off.

When the ignition is switched off, the steering lock may activate and you will no longer be able to steer the vehicle.

The start/stop system must be deactivated if work is to be carried out in the engine compartment.

NOTICE

If the start/stop system is used in very high outside temperatures over a long period, the 12-volt vehicle battery can be damaged.



The engine stop function may be deactivated automatically if the temperature is above around 38°C (100°F).



In some cases, it may be necessary to restart the engine manually. Follow any corresponding messages on the instrument cluster display.



The start/stop function is activated automatically if the Eco driving profile is selected on vehicles with driving profile selection ⇒ Driving profile selection and 4MOTION Active Control .



Always deactivate the start/stop system manually when driving through water.

Troubleshooting

Engine no longer starts automatically

Vehicles with DSG dual clutch gearbox and coasting function: if the engine does not start automatically, the warning Error: vehicle power system. Please visit workshop can be displayed in the instrument cluster.

Start the engine manually ⇒ Starting the engine .

Deactivate the start/stop system manually.

Go to a qualified workshop immediately.

Manual gearbox: selecting a gear

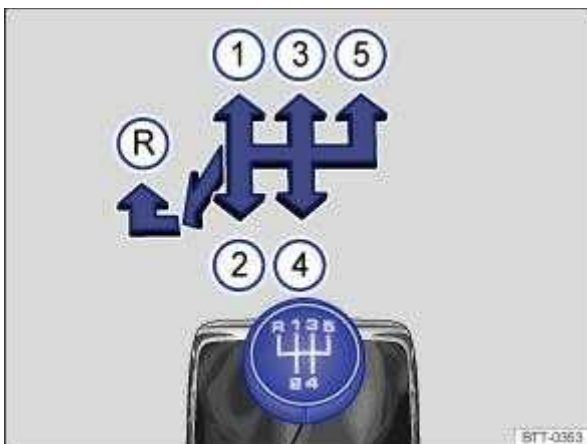

Fig. 103 Gear shift pattern of a 5-speed manual gearbox.



Fig. 104 Gear shift pattern of a 6-speed manual gearbox.

Selecting a forward gear

The positions of the individual driving gears are shown on the gearshift lever ⇒ Fig. 103 or ⇒ Fig. 104 .

Fully depress and hold the clutch pedal.

Move the gear lever to the required position ⇒ ⚠ .

Release the clutch to engage.

In some countries, the clutch pedal will have to be depressed fully in order to start the engine.

Selecting reverse gear

Reverse gear should be selected only when the vehicle is stationary.

Fully depress and hold the clutch pedal ⇒ ⚠ .

Move the gear lever to the neutral position and push down.

Push the gear lever fully to the left and then to the front into the reverse gear position ⇒ Fig. 103® or ⇒ Fig. 104® .

Release the clutch to engage.

Shifting down

Shifting down when the vehicle is in motion should always take place to the next lower gear and avoiding high engine speeds ⇒ ⚠ . At high speeds or high engine speeds, damage to the clutch and the gearbox could occur if one or more gears are skipped when shifting down gear, even if the clutch is not released when doing this ⇒ ⚠ .

⚠ WARNING

Rapid acceleration can cause loss of traction and skidding, particularly on slippery roads. This can cause you to lose control of the vehicle, which can lead to accidents and serious injuries.

Use fast acceleration only if visibility, weather, road and traffic conditions permit, and other road users are not put at risk due to the acceleration and driving style.

Always adjust your driving style in accordance with the flow of traffic.

When the TCS is switched off, the drive wheels may spin, especially if the road surface is wet, slippery or dirty. This may result in you no longer being able to steer or control the vehicle.

 WARNING

When the engine is running, the vehicle will start to move as soon as a gear is engaged and the clutch is released. This also applies when the electronic parking brake has been switched on.

Never engage reverse gear while the vehicle is in motion.

 WARNING

Shifting gears incorrectly to gears that are too low can lead to a loss of control over the vehicle, with accidents and serious injuries as a consequence.

 NOTICE

Serious damage to the clutch and gearbox could occur if the gear lever of the manual gearbox is shifted to a gear which is too low when travelling at high speeds or at high engine speeds. This also applies if the clutch remains depressed and the gears do not engage.

 NOTICE

Please note the following points in order to avoid damage and premature wear:

Do not rest your hand on the gear lever when driving. The pressure from your hand is passed onto the selector forks in the gearbox.

Ensure that the vehicle has come to a full stop before engaging reverse gear.

Always fully depress the clutch pedal when changing gear.

Do not hold the vehicle by riding the clutch on uphill gradients with the engine running.



Changing up a gear early will help to save fuel and minimise engine noise.

Troubleshooting

 Clutch slipping

The indicator lamp lights up yellow.

Clutch is not transmitting the full engine torque.

If necessary, remove foot from the clutch pedal.

 Clutch overheated

The indicator lamp lights up yellow.

An acoustic warning may also be given ⇒  .

The clutch can overheat, for example if the vehicle pulls off frequently, travels at a crawl for long periods, or in stop and go traffic.

Overheating is indicated by the warning lamp and in some cases by additional warning lamps and a text message in the instrument cluster display.

You can continue to drive.

 Clutch faulty

The indicator lamp lights up yellow.

The clutch is faulty.

Drive on carefully!

Seek expert assistance. Failure to do so can cause considerable clutch damage.

DSG® dual clutch gearbox

Function of the DSG® dual clutch gearbox

Description

The vehicle is equipped with a DSG® dual clutch gearbox.

The DSG® dual clutch gearbox is a gearbox which uses dual-clutch technology to change gear automatically. It uses a dual clutch and two gear train halves to enable very fast gear changes with no loss of torque. The DSG® dual clutch gearbox thus combines the performance and economy of a manual gearbox with the comfort and convenience of a conventional automatic gearbox.

Function

Engine power is transferred to the drive shaft via the gearbox. In order to change gears, the power transmission between the engine and the gearbox has to be interrupted. This is what the clutch is for.

With the DSG® dual clutch system with its two gear train halves, the engine power is always connected to one gear train half when driving. Before a gear shift, the next-higher or lower gear is already preselected in the load-free second gear train half. The clutch on the non-driven gear is then closed, and the other is opened at the same time. This makes very fast gear changes possible.

Thanks to its design, the DSG® dual clutch gearbox is more efficient than an automatic gearbox. Whereas in an automatic gearbox the torque converter is constantly in use, in the DSG® dual clutch

gearbox the clutch can be opened at idling speed, thus saving fuel. Thanks to its efficiency, low weight and intelligent control system, the DSG® dual clutch gearbox usually enables fuel consumption that is equal to or lower than a manual gearbox.

However, just like the manual gearbox, the clutch in the DSG® dual clutch gearbox is subject to wear. Regular maintenance is necessary depending on the type of DSG® dual clutch gearbox; further information ⇒ Scope of service . In the event of a fault in one gear train half, the DSG® dual clutch gearbox also allows one gear train half to be deactivated and the journey to be continued using the other gear train half ⇒ Troubleshooting . The gearbox must then be checked as soon as possible by a qualified workshop.

DSG® dual clutch gearbox: selecting a gear

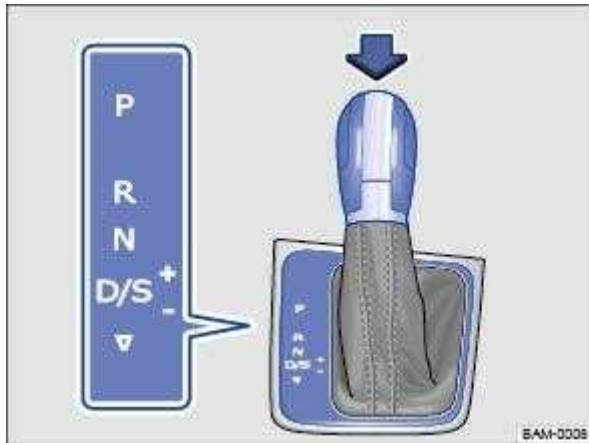

Fig. 105 Left-hand drive vehicles: selector lever for dual clutch gearbox DSG with lock button (arrow). The location is mirrored in right-hand drive vehicles.

When the ignition is switched on, the selected gear or gearbox programme is displayed in the instrument cluster display.

Instrument cluster display

Selector lever position	Display
P	P
R	R
N	N
D/S	E, D or S ⇒ Driving profile selection and 4MOTION Active Control
Tiptronic gate	M ⇒ Changing gear using Tiptronic

P – Parking lock

The drive wheels are locked mechanically. May be selected only when the vehicle is stationary. To disengage this selector lever position while the ignition is switched on, depress the brake pedal and press the lock button in the selector lever.

R– Reverse gear

Reverse gear is selected. May be selected only when the vehicle is stationary.

N– Neutral

The gearbox is in the neutral position. No force is transmitted to the wheels and the braking effect of the engine is not available.

D/S– Standard forward driving position

Position **D**: Normal programme.

All forward gears are shifted up and down automatically. The timing of the gear shift is determined by the engine load, your individual driving style and the speed of the vehicle.

Position **S**: Sport programme.

The forward gears are automatically changed up later and down earlier than in selector lever position D. This exploits the engine's full power reserves. The timing of the gear shift is determined by the engine load, your individual driving style and the speed of the vehicle.

To change between positions D and S, move the selector lever to the rear  ⇒ Fig. 105 .

The selector lever will always return to selector lever position D/S. That also works in the Tiptronic gate ⇒ Changing gear using Tiptronic .

Selector lever lock

P

N

To release the selector lever lock, switch on the ignition and depress the brake pedal. Then press the lock button in the selector lever handle in the direction of the arrow ⇒ Fig. 105 .

The selector lever lock is not engaged if the selector lever is moved quickly through position N, e.g. when shifting from reverse to D/S. This makes it possible, for instance, to rock the vehicle backwards and forwards if it is stuck in snow or mud. The selector lever lock engages automatically if the lever is in position N for more than approximately one second without the brake being pressed and when the vehicle is travelling no faster than approximately 5 km/h (3 mph).

 **WARNING**

Selecting the wrong position can cause you to lose control of the vehicle, which can lead to accidents and serious injuries.

Never depress the accelerator when selecting a position.

When the engine is running and a position is engaged, the vehicle will start moving as soon as the brake pedal is released.

Never shift to reverse or selector lever position P while the vehicle is moving.

 **WARNING**

Unintentional vehicle movements can cause serious injury.

The driver must never leave the driver seat when the engine is running and a position has been selected. If you have to leave the vehicle while the engine is running, always switch on the electronic parking brake and move the selector lever to position P.

If the engine is running and the selector lever is in position D/S or R, the vehicle must be held by the foot brake. The vehicle will creep forward even when the engine is idling, as power transmission is even then not fully interrupted.

Never select reverse or selector lever position P when the vehicle is in motion.

Never leave the vehicle in selector lever position N. The vehicle will roll downhill irrespective of whether or not the engine is running.

 **NOTICE**

If the electronic parking brake is not switched on when the vehicle is stationary and the brake pedal is released when the selector lever is in position P, the vehicle may move a few centimetres forwards or backwards.



If the lever is moved accidentally to N when driving, take your foot off the accelerator. Wait for the engine to reach idling speed in the neutral position before selecting a position again.



If the selector lever is left in any position other than P for long periods when the engine is switched off, the 12-volt vehicle battery will discharge.

Changing gear using Tiptronic

With a DSG® dual clutch gearbox, Tiptronic allows the gears to be shifted up and down manually.

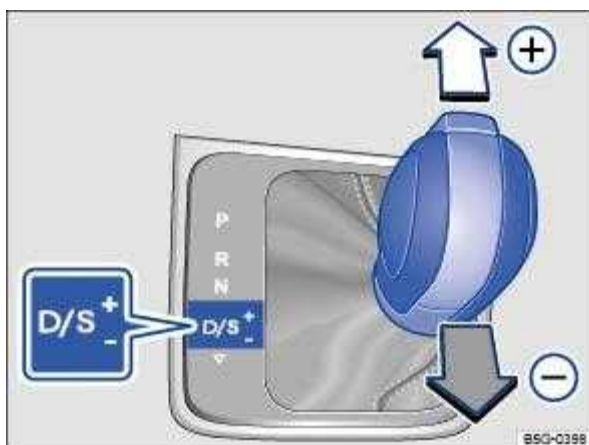

Fig. 106 Selector lever in Tiptronic position (left-hand drive). Mirror image for right-hand drive vehicles.

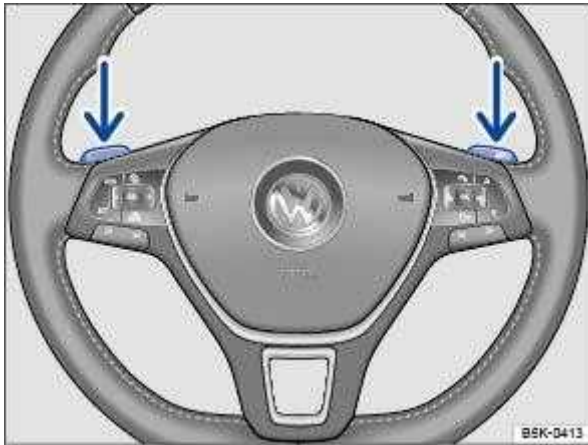

Fig. 107 Steering wheel with paddles for Tiptronic.

The gear that is currently selected will be maintained when the Tiptronic programme is selected. This remains the case as long as the system does not automatically carry out a change of gear due to the current driving situation.

Operating Tiptronic with the selector lever

Push the selector lever from position D/S to the right into the Tiptronic gate.

Tap the selector lever forwards \oplus or back \ominus to shift gear up or down \Rightarrow Fig. 106 .

When tapping the selector lever in the Tiptronic gate, it is not necessary to press the lock button on the selector lever.

Operating Tiptronic with the paddles

Pull the right paddle \Rightarrow Fig. 107 towards the steering wheel to change up a gear.

Pull the left paddle towards the steering wheel to change down a gear.

To leave Tiptronic mode, pull the right paddle towards the steering wheel for approximately one second.

Tiptronic is automatically deactivated if the selector paddles are not operated for some time and the selector lever is not in the Tiptronic gate.

NOTICE

When accelerating, the gearbox automatically shifts up to the next gear shortly before the maximum permitted engine speed is reached.

When shifting down a gear manually, the gearbox will not change gear until the engine can no longer be overrevved.

Driving with DSG® dual clutch gearbox

The gearbox changes the forward gears up and down automatically.

Driving down hills

The steeper the gradient, the lower the gear you will need. Lower gears increase the braking effect of the engine. Never allow the vehicle to roll down mountains or hills in the neutral position N.

Reduce your speed.

Push the selector lever from position D/S to the right into the Tiptronic gate ⇒ Changing gear using Tiptronic .

Tap the selector lever to the rear to change down gear.

OR: shift down a gear using the paddles on the steering wheel ⇒ Changing gear using Tiptronic .

Stopping and pulling away on an uphill gradient

The steeper the uphill gradient, the lower the gear you will need.

If you wish to stop the vehicle or pull away when driving uphill, you should use the Auto Hold function ⇒ Electronic parking brake .

When you stop the vehicle on an uphill gradient with a selected position, the vehicle must always be prevented from rolling by depressing the brake pedal or by applying the electronic parking brake. Do not release the brake pedal or switch off the electronic parking brake until you are about to pull away.

Coasting with DSG® dual clutch gearbox

In coasting mode, the momentum of the vehicle can be used to save fuel in conjunction with an anticipatory driving style. The engine no longer brakes the vehicle – the vehicle can roll for a longer distance. The function is available only in the selector lever position D and at speeds of approximately 40 – 130 km/h (25 mph – 80 mph).

Initiating coasting

Select the Eco driving profile in the driving profile selection menu ⇒ Driving profile selection and 4MOTION Active Control .

Take your foot off the accelerator. The engine will be disengaged and run at idling speed. The vehicle rolls without the braking effect of the engine.

If the speed falls below 130 km/h (80 mph).

Depress the accelerator briefly.

Cancelling coasting mode

Depress the brake pedal forcefully.

OR: depress the accelerator or brake pedal briefly.

OR: pull a paddle towards the steering wheel.

OR: press the selector lever to the Tiptronic position.

OR: change the driving profile from Eco.

Kickdown function

The kickdown function enables maximum acceleration in the selector lever position D/S or in the Tiptronic position.

If the accelerator is depressed fully, the gearbox will automatically shift to a lower gear, depending on the speed and engine speed. This will make use of the full vehicle acceleration.

With the kickdown function, the gearbox does not shift up to the next gear until the engine reaches the maximum engine speed for the gear.

When the Eco driving profile is selected in vehicles with driving profile selection ⇒ Driving profile selection and 4MOTION Active Control and the accelerator is depressed fully beyond the pressure point, the engine output is automatically regulated to ensure maximum vehicle acceleration.

WARNING

Rapid acceleration can cause loss of traction and skidding, particularly on slippery roads. This can cause you to lose control of the vehicle, which can lead to accidents and serious injuries.

Always adjust your driving style in accordance with the flow of traffic.

Use the kickdown function or fast acceleration only if visibility, weather, road and traffic conditions permit, and if other road users are not put at risk due to the acceleration and the driving style.

Please note that the driven wheels could start to spin and the vehicle could skid if the TCS is switched off and especially if the road is slippery.

WARNING

Never let the brakes rub too often and for too long or operate the brake pedal too often or for too long. Constant braking will cause the brakes to overheat. This will considerably reduce the braking power, significantly increase the braking distance and could cause the brake system to fail completely.

NOTICE

Never let the brakes rub by applying light pressure when it is not necessary. This will increase levels of wear.

Troubleshooting

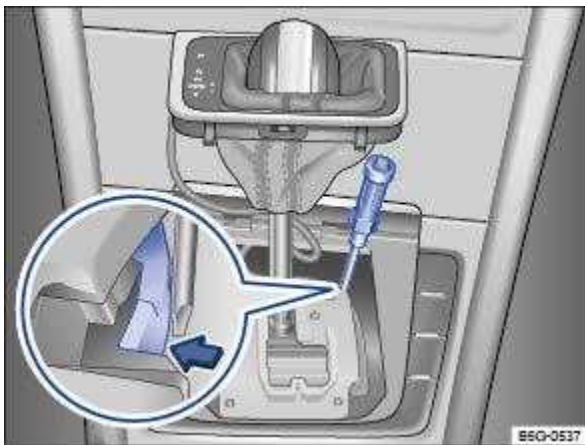

Fig. 108 Removing the cover of the gearshift gate and manually releasing the selector lever lock.

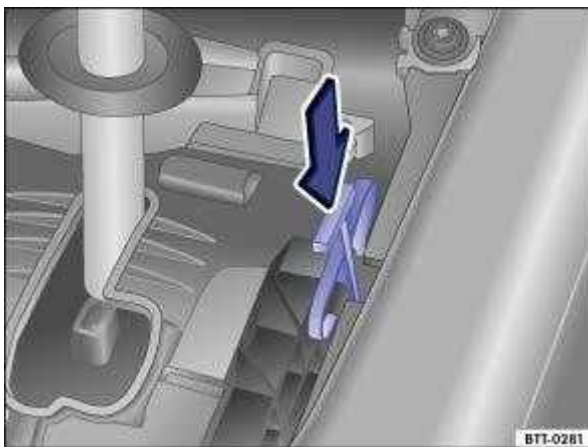

Fig. 109 Unlocking the selector lever lock manually.

⊘ Engine does not start

The indicator lamp lights up green.

Brake pedal was not depressed, e.g. when trying to engage another position with the selector lever.

To select a position, press the brake pedal ⇒ Notes on driving .

Also see Electronic parking brake ⇒ Electronic parking brake .

⊘ Driving off is prevented by the lock button

The indicator lamp flashes green.

The lock button in the selector lever is not engaged.

Engage the selector lever lock.

⊘ Driving off is prevented by the selector lever lock

The indicator lamp flashes green. An information text is additionally displayed.

In rare cases, the selector lever lock may not engage in vehicles with a DSG® dual clutch gearbox.

The drive is then deactivated to prevent the vehicle from accidentally pulling away.

Depress the foot brake and then release it again.

 Distance from vehicle ahead too close

The warning lamp lights up red.

Brake request by ACC ⇒ Adaptive Cruise Control (ACC) .

The brake pedal was not depressed or not fully depressed.

Brake immediately.

 Gearbox overheated

The indicator lamp lights up yellow.

A signal tone may also be given. A text message may also be shown on the instrument cluster display.

The DSG® dual clutch gearbox can become too hot, for example, if the vehicle pulls off regularly, during long periods at crawling speed, or in stop-and-go traffic.

Do not drive on!

Allow the gearbox to cool down in selector lever position P ⇒  .

Do not drive on if the indicator lamp does not go out.

Seek expert assistance. Failure to do so could result in considerable damage to the gearbox.

Releasing the selector lever lock manually

If the power fails in the vehicle (for example if the 12-volt vehicle battery is flat) and the vehicle has to be towed, the selector lever lock must be released manually. Seek expert assistance for this.

The manual release mechanism is located under the cover of the gearshift gate.

Removing the cover of the gearshift gate:

Switch on the electronic parking brake. If the electronic parking brake cannot be switched on, the vehicle will have to be prevented from rolling away using other means.

Switch off the ignition.

Carefully pull the cover upwards in the area around the selector lever gaiter with connected electrical wiring ⇒ Fig. 108 .

Pull the cover up and over the selector lever ⇒  .

Depending on the vehicle equipment, there are two possible manual release mechanism variants.

Releasing the selector lever lock manually:

Using the flat blade of the screwdriver from the vehicle toolkit, carefully push the release lever in the direction of the arrow and keep it in this position ⇒ Fig. 108 .

Press the lock button on the front of the selector lever and move the selector lever into position N.

After manual unlocking, carefully press the cover into the centre console while ensuring that the electrical wires are positioned correctly.

Using the flat blade of the screwdriver from the vehicle toolkit, carefully push the release lever in the direction of the arrow and keep it in this position ⇒ Fig. 109 .

Press the lock button on the front of the selector lever and move the selector lever into position N.

After manual unlocking, carefully press the cover into the centre console while ensuring that the electrical wires are positioned correctly.

Emergency programme

There is a fault in the system if all the displays on the instrument cluster for the selector lever positions have a light background. The DSG® dual clutch gearbox is running in an emergency programme. The vehicle can still be driven in the emergency programme, but only at reduced speed and not in all gears.

In vehicles with a DSG® dual clutch gearbox, you may no longer be able to select reverse gear.

In all cases, you should have the DSG® dual clutch gearbox checked by a qualified workshop immediately.

Vehicle does not move even though position is engaged

If the vehicle will not move in the required direction, the system may have selected the position incorrectly.

Depress the brake pedal and reselect the position.

If the vehicle still does not move in the required direction, there is a system fault. Seek expert assistance and have the system checked.

WARNING

Never move the selector lever out of the position P if the electronic parking brake is not switched on. Otherwise the vehicle could move unexpectedly if it is stopped on an uphill or downhill gradient, which could lead to accidents and serious injuries.

NOTICE

If the vehicle rolls for an extended period or at high speed with the engine switched off and the selector lever in the position N, the DSG® dual clutch gearbox will be damaged, e.g. when being towed.

NOTICE

If the display indicates that the gearbox is overheating for the first time, the vehicle must either be parked safely or driven faster than 20 km/h (12 mph).

If the text message and signal tone are repeated approximately every 10 seconds, park the vehicle safely as soon as possible and switch the engine off. Allow the gearbox to cool down.

Do not drive on until the signal tone stops in order to avoid damage to the gearbox. You should not pull away or drive the vehicle at very low speeds while the gearbox is overheated.

Downhill speed control

The downhill speed control system helps when braking and travelling downhill in vehicles with a DSG® dual clutch gearbox ⇒ . The downhill speed control uses the braking power of the engine.

The DSG® dual clutch gearbox selects the best gear depending on the steepness of the gradient and the current speed. The selector lever must be in position D/S. The downhill speed control is not active in Tiptronic mode.

As the downhill speed control can shift down only as far as third gear, it may be necessary to activate the Tiptronic mode when driving down particularly steep inclines. When in Tiptronic mode, select second or first gear manually in order to make use of the braking effect of the engine and to relieve the load on the brakes.

The start/stop system is automatically deactivated as long as downhill speed control is active.

Activating downhill speed control automatically:

If the downhill gradient is greater than approximately 6%.

AND: if the selector lever is in position D/S.

In addition, if the cruise control system or Adaptive Cruise Control (ACC) is switched off: if the vehicle speed is less than approximately 80 km/h (50 mph) or the brake pedal is depressed.

In addition, if the cruise control system or Adaptive Cruise Control (ACC) is active: if the stored speed is exceeded.

Deactivating downhill speed control automatically:

If the downhill gradient becomes less steep.

OR: if the gearbox shifts up a gear because the engine speed is higher than approximately 4,500 rpm.

Or additionally if the cruise control system or Adaptive Cruise Control (ACC) is active: if the stored speed can be maintained.

WARNING

The intelligent downhill speed control technology cannot overcome the laws of physics, and functions only within the limits of the system. Never let the extra convenience afforded by pull-away assist systems tempt you into taking any safety risks when driving.

Unintentional vehicle movements can cause serious injury.

The downhill speed control cannot replace the full concentration of the driver.

Always adapt your speed and driving style to suit visibility, weather, road and traffic conditions.

The downhill speed control cannot hold the vehicle on the gradient in all situations or brake it sufficiently on all slopes going downhill (e.g. if the ground is slippery or icy).

WARNING

Always be prepared to brake the vehicle. Accidents and injuries could occur if you are not prepared to brake.

The downhill speed control is only a support function and may not be able to brake the vehicle sufficiently in all situations when driving downhill.

The vehicle may become faster despite the downhill speed control being in operation.

Steering

Information on steering

The steering should be locked every time you leave the vehicle to make it more difficult for the vehicle to be stolen.

The steering

The power steering is not hydraulic, but is an electromechanical system. The advantage of this steering system is that no hydraulic hoses, hydraulic oil, pumps, filter or other parts are required. The electromechanical system reduces fuel consumption. A hydraulic system requires constant oil pressure in the system, whereas an electromechanical steering system only needs an energy supply while steering.

In vehicles with driving profile selection, the selected driving profile can affect the behaviour of the power steering ⇒ Driving profile selection and 4MOTION Active Control .

Electronic steering column lock in vehicles with a starter button

The steering column will be locked if the driver door is opened when the ignition is switched off. For this, the vehicle should be stationary and, if necessary, the gear selector lever should be in position P.

If the ignition is not switched off until after the driver door is opened, the electronic steering column will only be locked when the vehicle is locked using the sensor in the door handle or the vehicle key.

Mechanical steering column lock (steering lock) in vehicles with an ignition lock

The steering column is locked if the vehicle key is removed from the ignition lock when the vehicle is stationary. Turn the steering wheel slightly until the steering lock audibly engages.

Insert the vehicle key into the ignition lock to unlock the steering lock. Turn the steering wheel slightly to relieve the load on the steering lock mechanism. Hold the steering wheel in this position and turn the ignition on.

Electromechanical steering

The steering assistance provided by the electromechanical steering system automatically adjusts to the vehicle speed, steering wheel torque and steering wheel angle. The electromechanical steering functions only when the engine is running.

You will need considerably more strength than normal to steer the vehicle if the power steering is reduced or has failed completely.

Counter steering assistance

Counter steering assistance provides the driver with steering assistance in critical driving situations. Additional steering forces assist the driver when counter steering ⇒ .

Progressive steering

Depending on the vehicle equipment level, progressive steering can adjust the steering response in a driving situation. Progressive steering functions only when the engine is running.

In urban traffic, less steering input is required when parking, manoeuvring, or turning sharply.

When driving on country roads or on the motorway, the progressive steering provides a more sporty, direct steering response, and a dynamic feel.

WARNING

If the power steering is not working, the steering wheel is difficult to turn, which makes it difficult to steer the vehicle.

Depending on the vehicle equipment level, the power steering functions only when the engine is running.

Never allow the vehicle to roll if the engine is switched off.

Never remove the vehicle key from the ignition if the vehicle is in motion. The steering column lock may be activated and it will no longer be possible to steer the vehicle.

WARNING

In conjunction with the ESC, counter steering assistance provides the driver with assistance when steering in critical driving situations. The driver must steer the vehicle at all times. Counter steering assistance does not steer the vehicle.

NOTICE

When the vehicle is towed, the ignition must be switched on to prevent the steering wheel from locking, and so that the turn signals, horn, wipers and window washer system can be used.

Troubleshooting

Steering requires increased force

The indicator lamp lights up yellow.

The steering should be checked by a qualified workshop as soon as possible.

If the yellow warning lamp remains off after the engine has been restarted and you have driven a short distance, you do not need to consult a qualified workshop.

 Fault in steering

The indicator lamp lights up yellow.

The 12-volt vehicle battery was disconnected.

Drive a short distance at a speed of 15 – 20 km/h (9 – 12 mph).

If the yellow warning lamp is still lit after the engine has been restarted, have the steering checked by a qualified workshop immediately.

 Fault in steering

The indicator lamp flashes yellow.

Turn the steering wheel back and forth.

Switch the ignition off and then on again.

Observe the messages on the instrument cluster display.

Do not continue your journey if the indicator lamp still flashes when the ignition is switched on.

Seek expert assistance.

 Steering column is not unlocked or locked

The indicator lamp flashes yellow.

Follow any messages that are on the instrument cluster display.

Switch the ignition off and then on again.

Do not continue your journey if the steering column remains locked when the ignition is switched on.

Seek expert assistance.

 Steering requires increased force

The warning lamp lights up red.

The electromechanical steering has failed.

Do not drive on!

Seek expert assistance.

Driving profile selection and 4MOTION Active Control

This chapter contains information on the following subjects:

⇒ Setting a driving profile

⇒ Individually adapting a driving profile

⇒ Troubleshooting

By selecting different driving profiles, the driver can adapt the characteristics of the vehicle systems to the current driving situation, the desired ride comfort and an economical driving style. The adaptable vehicle systems include the running gear, engine management system or the air conditioning system.

Different driving profiles can be selected depending on the vehicle equipment level. The effect on the vehicle setup in the individual driving profiles varies according to the vehicle equipment.

The Comfort driving profile is available only for vehicles with adaptive chassis control (DCC).

The setting options available depend on the type of drive. Vehicles with front-wheel drive have onroad driving profiles, while vehicles with all-wheel drive have additional offroad driving profiles
⇒ Setting a driving profile .

The driving profile can be changed when the vehicle is stationary or while driving ⇒  . After selecting a driving profile, the vehicle settings (excluding engine settings) are switched to the new driving profile immediately. When traffic conditions allow, briefly take your foot off the accelerator to activate the newly selected driving profile for the engine also.

 **WARNING**

Selecting a driving profile while the vehicle is in motion can distract you from the road and cause accidents.



Some settings can be stored in the user accounts of the personalisation function and therefore change automatically when the user account changes ⇒ Personalisation .

Setting a driving profile



Fig. 110 In the lower section of the centre console: driving profile selection button.

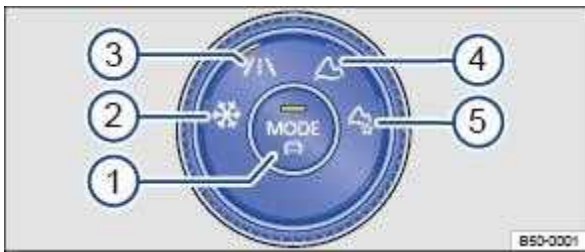

Fig. 111 In the lower section of the centre console: control for the 4MOTION Active Control in vehicles with all-wheel drive.

 First read and observe the introductory information and safety warnings ⇒  Introduction

Key to ⇒ Fig. 111 :

- ① MODE button: select onroad driving profiles and open menu in the Infotainment system.
- ② Snow driving profile.
- ③ Onroad driving profile.
- ④ Offroad driving profile.
- ⑤ Offroad Individual driving profile.

Selecting a driving profile

Switch on the ignition.

Front-wheel drive: press the driving profile selection button  ⇒ Fig. 110 .

All-wheel drive: turn the control for 4MOTION Active Control until the LED next to the desired driving profile lights up ⇒ Fig. 111 .

Front-wheel drive: to change driving profiles, press the driving profile selection button  ⇒ Fig. 110 again or touch the function button of the desired driving profile in the Infotainment system.

All-wheel drive: to switch the onroad driving profiles, press the MODE button or touch an onroad driving profile in the Infotainment system.

Touch the  function button in the Infotainment system to display additional information about the active driving profile.

Vehicles with front-wheel drive: if the Normal driving profile is selected, the LED in the driving profile selection button will remain switched off.

When the ignition is switched off, the set driving profile and the individual settings will remain selected.

Vehicles with all-wheel drive: if the Snow, Offroad or Offroad Individual driving profile was selected last, the onroad driving profile that was last active will be activated after the ignition has been switched off for a long period.

Vehicles without starter button: as soon as the vehicle key is removed from the ignition lock.

Vehicles with starter button: as soon as the driver door is opened when the ignition is switched off.

Sport functions: select Sport driving profile again.

OR: tap the selector lever of the DSG® dual clutch gearbox backwards to the position S ⇒ DSG® dual clutch gearbox .

Eco functions: select Eco driving profile again.

Characteristics of the driving profiles

Snow: the Snow driving profile makes it easier to control the throttle on icy or snowy roads. It is not possible to select the S position in the Snow driving profile.

Onroad: under Onroad, you can choose between Eco, Comfort, Normal, Sport and Individual driving profiles.

Offroad: the Offroad driving profile makes it easier to control the throttle when driving offroad. The engine brake is always available and gearshifts can be prevented in critical situations. Hill Start Assist and Hill Descent Control are active in the Offroad driving profile. It is not possible to select the S position in the Offroad driving profile. When the driving profile is active, the instrument cluster

displays the symbol  .

Offroad Individual: enhanced version of the offroad driving profile that can be adapted to the driver's needs ⇒ Individually adapting a driving profile . When the driving profile is active, the

instrument cluster displays the symbol  .

Eco: switches the vehicle into economical mode and helps the driver to drive the vehicle in a fuel-efficient manner. Depending on the vehicle equipment level, coasting mode is available in the Eco driving profile.

Comfort: the driving profile creates a comfort-oriented vehicle setup and is suited to poor roads or long motorway journeys, for example.

Normal: the driving profile has a balanced setup, e.g. for everyday use.

Sport: this setting gives the driver a sporty driving feeling.

Individual: individual vehicle systems can be adjusted to suit personal requirements ⇒ Individually adapting a driving profile .

WARNING

The vehicle handling may change as a result of the different driving profiles. Never allow driving profile selection to tempt you into taking any risks when driving.

Always adapt your speed and driving style to the current visibility, weather and road or traffic conditions.



In vehicles with a DSG® dual clutch gearbox, the system automatically changes to gear position S when the Sport driving profile is selected. The system automatically change to gear position D when the Eco driving profile is selected. Since coasting is active in the Eco driving profile, the gearbox programme E is additionally displayed on the instrument cluster display.

Individually adapting a driving profile



First read and observe the introductory information and safety warnings ⇒  Introduction

Selecting the Individual driving profile

Switch on the ignition.

Switch on the Infotainment system.

Press the  driving profile selection button or turn the control for 4MOTION Active Control until the LED next to the Onroad driving profile ⇒ Fig. 111 ③ lights up.

Touch the Adjust function button to open the Individual menu.

Selecting the Offroad Individual driving profile

Switch on the ignition.

Switch on the Infotainment system.

Turn the control for the 4MOTION Active Control until the LED next to the Offroad Individual driving profile ⇒ Fig. 111 ⑤ lights up.

If the Offroad Individual driving profile is already selected, press the MODE button on the control ⇒ Fig. 111 .

Touch the Adjust function button to open the Individual menu.

Troubleshooting



First read and observe the introductory information and safety warnings ⇒  Introduction

 Fault in the adaptive chassis control (DCC)

The indicator lamp lights up yellow.

Go to a qualified workshop and have the system checked.

 Fault in Hill Start Assist

Go to a qualified workshop and have the system checked.

Offroad display

The offroad display contains digital instruments that show additional information about the vehicle and its surroundings. This makes it possible to assess the current driving situation more precisely.



Fig. 112 In the Infotainment system: offroad display.

Opening the offroad display

Press the **MENU** button on the Infotainment system.

Touch the Vehicle function button.

Touch the Selection function button.

Touch the Offroad function button.

Selecting instruments and setting units

The Infotainment system displays various instruments ⇒ Fig. 112 .

To change instruments, swipe vertically over the display.

The units can be adjusted for some instruments in the Infotainment system ⇒ Infotainment system controls and displays .

Instruments in the offroad display:

Altimeter: the altimeter shows the current height above sea level.

Steering angle display: the steering angle of the vehicle is displayed in the range between -49° and 49°. The value is positive for a left steering angle and negative for a right steering angle.

Compass: the compass shows the current driving direction.

Coolant temperature display: the display corresponds to the temperature display on the instrument cluster ⇒ Coolant temperature display .

Oil temperature display: the display corresponds with the oil temperature display on the instrument cluster ⇒ Engine oil .

Adapting the display areas to the driving situation

The displayed instruments can be selected according to the driving situation, the ambient conditions and the offroad conditions:

Sandy terrain: oil, steering angle and coolant temperature display

Inclines: steering angle and coolant temperature display, altimeter

Alpine terrain: steering angle display, altimeter, compass

Offroad driving situations



Introduction

This chapter contains information on the following subjects:

⇒ Safety instructions for offroad driving

⇒ Explanation of some technical terms

⇒ Checklist

⇒ General rules and driving tips

⇒ Useful accessories for offroad driving

⇒ Changing gear correctly

⇒ Driving on rough terrain

⇒ Driving through water

⇒ Offroad driving in snow

⇒ Driving on sand and mud

⇒ Driving on steep terrain

⇒ Traversing a slope

⇒ Driving through ditches

⇒ Stuck vehicle

⇒ After offroad driving

You can also drive vehicles with all-wheel drive offroad in addition to on normal roads. It is very important to read the contents of this section before driving offroad.

The vehicle is not built for expedition-type journeys.

The examples given in this chapter are an aid for safe offroad driving. However, we cannot predict whether these guidelines will be valid for all situations that could occur.

The many different types of terrain and the associated risks and dangers make it impossible to describe all possible driving situations. The examples are only general guidelines which are intended to help you to drive offroad safely. It is crucial that you know what to expect when you drive into offroad terrain you are unfamiliar with. This will enable you to assess potential dangers in advance.

The driver can use 4MOTION Active Control to activate a variety of vehicle settings in an all-wheel drive vehicle as required ⇒ Setting a driving profile .

Checklist

Before driving offroad for the first time, take the following steps so you can operate and drive the vehicle safely offroad:

Observe the basic safety notes Safety instructions for offroad driving.

Familiarise yourself with the vehicle controls.

Check and adjust the seat position Sitting position and fasten the seat belts Seat belts.

Check distance to steering wheel and adjust Steering wheel.

Always wear suitable, well-fitting shoes that provide good grip for your feet when operating the pedals.

Safety instructions for offroad driving



First read and observe the introductory information and safety warnings ⇒  Introduction

WARNING

The intelligent vehicle technology cannot overcome the laws of physics, and functions only within the limits of the system. Despite ABS, instability through locked wheels can occur on adverse terrain – e.g. if you brake hard when driving on a loose gravel road. The Electronic Stability Control will be able to stabilise the vehicle only to a limited extent in these circumstances.

WARNING

Driving offroad can be dangerous and could cause accidents, serious injury, damage to the vehicle and also a vehicle breakdown far from any assistance.

Never select a dangerous route and never take risks that could endanger you and your passengers. If you cannot drive on or if you are in any doubt about the safety of the route, turn round and choose another route.

Even terrain that looks harmless can be difficult and dangerous, and could get you and your passengers into difficulties. We recommend inspecting the terrain on foot beforehand.

You should drive particularly carefully and think ahead when driving offroad. If you drive too fast or if a driving manoeuvre is unsuccessful, this could result in serious injuries and vehicle damage.

Never drive faster than the current terrain, road conditions, traffic and weather allow.

Never drive too fast over embankments, ramps or slopes. This could cause the vehicle to lose contact with the ground. If this happens, you will be unable to steer and will lose control of the vehicle.

If the vehicle does lose contact with the ground, always point the front wheels straight ahead. If the wheels are not pointing straight ahead when the vehicle lands, it could roll over.

Terrain might look harmless, but there could be hidden dangers. Potholes, hollows, ditches, precipices, obstacles, shallows, soft and boggy surfaces are often not recognisable as such and can be covered either fully or partly by water or grass or branches lying on the ground. Inspect terrain on foot if necessary.

 **WARNING**

Sporty multipurpose vehicles are subject to a considerably higher risk of rolling over than normal road passenger vehicles ⇒ Explanation of some technical terms .

In the event of an accident, vehicle occupants not wearing seat belts are subjected to a considerably higher risk of fatal injury than those wearing seat belts.

The vehicle has a higher centre of gravity and is more prone to rolling over than a normal passenger car which is unsuited for offroad driving.

Never drive too fast, especially when driving through bends, or carry out any extreme driving manoeuvres.

Always adjust your speed and driving style to the terrain.

Luggage and other items transported on the roof of the vehicle raise the centre of gravity and will make the vehicle more likely to roll over.

 **WARNING**

The terrain might look harmless, but there could be hidden dangers. Potholes, hollows, ditches, precipices, obstacles, shallows, soft and boggy surfaces are often not recognisable as such and can be covered either fully or partly by water or grass or branches lying on the ground. Driving offroad over such terrain could cause accidents, serious injury and also a vehicle breakdown.

Carefully inspect any unknown sections of the terrain on foot before driving through them.

Never choose an unsafe route or take a risk which could endanger you or your passengers. If you are in any doubt about the safety of the route, turn round and choose another way.

Always adjust your speed and driving to match vehicle load levels and visibility, terrain and weather conditions.

 WARNING

Always avoid traversing a slope ⇒ Traversing a slope .

Vehicle occupants should never leave the vehicle via the doors facing down the hill when stopped sideways on a steep hill. The combined centre of gravity of the vehicle and its payload (vehicle occupants and payload) can shift and cause the vehicle to roll over and roll down the incline. Always leave the vehicle slowly via the doors which open up the incline ⇒ Traversing a slope .

 WARNING

The cruise control system has been designed for use on surfaced roads only. The cruise control system is not suitable for use offroad and may even be hazardous. If you use the cruise control system while driving offroad, you may lose control over the vehicle and sustain serious injuries.

Never use the cruise control system when driving offroad.

 WARNING

The area monitoring system (Front Assist) was developed for use on surfaced roads only. The area monitoring system is not suitable for use offroad and may even be hazardous. If you use the area monitoring system while driving offroad, you may lose control over the vehicle and sustain serious injuries.

Never use the area monitoring system when driving offroad.

 WARNING

Driving the vehicle when the fuel level is too low could lead to your vehicle breaking down offroad, accidents and serious injuries.

When the fuel level is too low, the fuel supply to the engine could be irregular, especially when driving up or down hills and inclines.

The steering, all driver assist systems and brake support systems will not function if the engine sputters or stops completely due to a lack of fuel or irregular fuel supply.

Always fill the tank when it is still 1/4 full. This reduces the risk of running out of fuel and breaking down.

 NOTICE

Any rain entering the vehicle when the windows or glass roof are open can soak the interior equipment and cause damage to the vehicle. Always keep the windows and glass roof closed when driving offroad.

Explanation of some technical terms

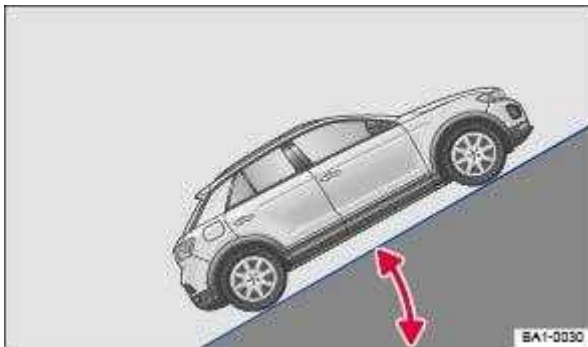

Fig. 113 Illustration: angle of gradient.

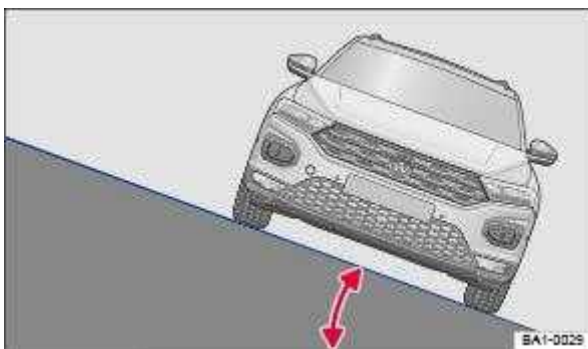

Fig. 114 Illustration: tilt angle.



First read and observe the introductory information and safety warnings ⇒ Introduction

Centre of gravity The centre of gravity of a vehicle influences its propensity to roll over. The vehicle has greater ground clearance for offroad driving, and thus a higher centre of gravity than a normal vehicle. The high centre of gravity means that there is a greater danger of roll-over when driving. Always remember this fact when driving and follow the safety tips and warnings given in this owner's manual.

Ground clearance This is the vertical distance between the ground and the lowest item on the vehicle underbody.

Angle of gradient The number of metres in height gained over a distance of 100 m is given as a percentage or degree ⇒ Fig. 113 . Indication of gradient that the vehicle can drive up under its own power. This depends on aspects such as the road surface and engine power.

Tilt angle Maximum angle at which the vehicle may be driven across a slope without the vehicle tipping over (determined by centre of gravity) ⇒ Fig. 114 .

Breakover angle Maximum permitted angle given in degrees that a vehicle driven at low speed can clear a ramp without the underbody of the vehicle scraping the ramp.

Ramp angle Crossover from the horizontal level surface to an uphill gradient, or from a downhill gradient back to the level surface. Angle up to which the vehicle bottoms with the underbody on the ramp edge.

Fall line This is the vertical drop route.

Articulation The articulation capability of the vehicle when driving over objects with just one side of the vehicle.

Checklist before driving offroad



First read and observe the introductory information and safety warnings ⇒ Introduction

Checklist

To ensure your own safety and the safety of your passengers, observe the following points before driving offroad:



Obtain sufficient information before driving into offroad terrain with the vehicle.



Do not plan day stages that are too long. Take increased fuel consumption for offroad driving into account.



Fill up the tank. Fuel consumption is considerably higher offroad.



Check that your tyres are suitable for the offroad journey you have planned. Recommendation for difficult offroad terrain: always have offroad tyres fitted to your vehicle.



Check the tyre pressure on all tyres and correct if necessary. This includes the temporary spare wheel, if present.



Check engine oil level and refill engine oil as necessary. The engine will be supplied with engine oil when it is driven on or across a slope only if the engine oil level is sufficient.



Completely refill the washer fluid reservoir with water and washer fluid.



Fit the towing eye at the front or rear. It is not always possible to fit the towing eye when the vehicle is stuck.



Check the vehicle toolkit and add tools according to individual requirements Useful accessories for offroad driving.



Stow luggage in the vehicle as evenly and as low as possible. Secure all loose items.

Before driving offroad, Volkswagen recommends attending an offroad driving course, particularly if you have no or very little experience.

A good driving course will teach you how to handle the vehicle in a variety of offroad situations and how to drive safely in difficult terrain. Driving offroad demands different skills and driving styles in comparison to driving on roads. The safety of the driver and the vehicle occupants depends on the driver.

General rules and driving tips



First read and observe the introductory information and safety warnings ⇒  Introduction

Code of conduct for offroad driving

A responsible driver should respect the environment when driving offroad. Remember that driving through undergrowth and on meadows can destroy animal and plant habitats.

Always stay on designated routes and paths.

Do not create any unnecessary noise or dust.

Leave nature as you found it.

Avoid sensitive natural habitats.

Give way to drivers coming uphill or who are overtaking.

Driving tips

Special rules apply when driving offroad:

Never drive offroad alone. Always drive offroad in a team of at least two offroad vehicles.

Unexpected situations can always occur. We recommend that you carry equipment you can use for calling for help.

Stop your vehicle when you reach difficult sections, and walk along the route ahead to inspect it.

Drive slowly over the crests of hills so the vehicle does not lose contact with the ground. This could cause damage, leaving you unable to manoeuvre.

Drive slowly when the route is difficult. Shift up a gear when on slippery ground and always keep the vehicle in motion.

Always look for flat and firm surfaces. The ground is predominantly soft when driving offroad, meaning the tyres could sink into the ground. This will reduce ground clearance and the fording depth.

Even when driving at low speeds, always keep your distance from other vehicles. If the first vehicle suddenly gets stuck, the following vehicle then can stop without getting stuck itself.



NOTICE

Always ensure that there is enough ground clearance underneath the vehicle. Serious damage to the underbody could occur if the vehicle bottoms on the ground. This damage could cause the vehicle to break down and thus make it impossible to drive on.

Do not slip the clutch or rest your foot on the clutch when driving offroad. When travelling over uneven ground, you could press the clutch by mistake and lose control of the vehicle. This also prevents power being transferred between the engine and the gearbox. In addition, driving with the clutch partially engaged causes premature wear to the clutch lining.

Useful accessories for offroad driving



First read and observe the introductory information and safety warnings ⇒ ⚠ Introduction

The checklist contains just a few items of equipment that can be very useful for offroad driving. If you have an instruction manual or fitting instructions for these accessories, you should always take them with you and observe them as necessary when driving offroad.

Checklist

Useful items when driving offroad:



Water, compass, maps and torch with spare batteries.



Winch, tow bar or rope with sufficient strength.



Mobile telephone, shovel, blankets and rubber boots.



Electrical air compressor for connection to the 12-volt sockets in the vehicle to inflate the tyres.



A wooden board approx. 4 cm thick and approx. 1 metre long or an aluminium frame of similar size: this can be used to free a vehicle stuck in the mud and provide a platform for a vehicle jack.



Snow chains, additional spare wheels, a breakdown set, jack and box spanner.

Changing gear correctly



First read and observe the introductory information and safety warnings ⇒ ⚠ Introduction

The correct choice of gear depends on the offroad terrain.

Before attempting to drive through difficult terrain it can be helpful to stop and consider which gear you should select. After several trips offroad, you will learn which gear to select in conjunction with the step-down ratio and differential locks for different types of terrain.

General rules

With the correct gear selected, the vehicle will normally not have to be braked so much using the foot brake when driving downhill as the engine braking effect will normally be sufficient.

You should only depress the accelerator as much as is required. If you accelerate too hard, the wheels could lose traction and you could lose control of the vehicle.

DSG® dual clutch gearbox

Select position D when driving in normal, flat offroad terrain.

Adjust your speed when driving on soft or slippery ground, and select the highest suitable position for the Tiptronic.

If driving through mud, sand, water or hilly terrain, drive with Tiptronic in the positions 3 or 2 ⇒ DSG® dual clutch gearbox .

Use the offroad display ⇒ Offroad display .

Driving on rough terrain



First read and observe the introductory information and safety warnings ⇒ Introduction

Use the offroad driving profile ⇒ Setting a driving profile .

You should drive through rocky terrain at no faster than walking pace.

If you are not able to drive around a rock, drive carefully onto the rock with one front wheel and drive over it slowly ⇒ .

.

NOTICE

You should never drive straight over large obstacles, e.g. boulders or tree stumps, or drive over such obstacles with one side of the vehicle. Obstacles which require more ground clearance than is available could damage vehicle components when you drive over them and thus cause the vehicle to break down.

Even obstacles that are smaller than the available ground clearance could come into contact with the vehicle underbody and thus cause damage which could lead to a vehicle breakdown. This applies in particular if there is a hollow or soft ground either in front of or behind the obstacle. This also applies in cases when you drive too quickly over the obstacle causing the vehicle to bounce.



Escaping engine oil and brake fluid can pollute the environment. Spilt service fluids must be collected and then disposed of properly and in an environmentally responsible way.

Driving through water



First read and observe the introductory information and safety warnings ⇒ Introduction

Driving through flooded terrain could damage the vehicle ⇒ Checklist before driving offroad .

You can drive the vehicle carefully through water with a depth reaching to the bottom edge of the body, for example puddles or shallow water. Never stop in the water, do not reverse, and never switch off the engine.

Observe further information on driving through water on roads ⇒ Driving through water .

 **WARNING**

Flowing water can develop enormous power and sweep the vehicle away. This can lead to very dangerous situations which can cause accidents and serious or even fatal accidents.

Never stop the vehicle when in water.

Water in the engine compartment can cause the vehicle to break down in the water.

Soft ground surfaces, underwater obstacles and shallows can cause accidents and can cause the vehicle to breakdown in the water. This could lead to critical situations.

 **NOTICE**

If you drive through water, parts of the vehicle, such as the engine, drive train, running gear and vehicle electrics, could sustain severe damage.

When driving through water, always select a section where the ground is solid and where the depth of the water does not exceed the maximum permitted fording depth of the vehicle.

Never drive through salt, salty surfaces or salt water as salt can cause corrosion. Rinse off all components that have been exposed to salt or salt water immediately with fresh water.

Offroad driving in snow

 First read and observe the introductory information and safety warnings ⇒  Introduction

Fit snow chains to the front wheels only before driving on snow-covered terrain.

Terrain might look harmless, but there could be hidden dangers. This is particularly true of sections where there are no visible tyre tracks or other tracks.

 **WARNING**

Driving in snow-covered terrain is very dangerous.

Both shallow and deep potholes, hollows, ditches, precipices, frozen surfaces and other obstacles can be fully or partially covered by snow.

Dangers concealed by snow can cause an accident, serious injuries, or cause the vehicle to break down in extreme weather conditions.



Always adjust your speed and driving to match vehicle load levels and visibility, terrain and weather conditions.

Driving on sand and mud



First read and observe the introductory information and safety warnings ⇒  Introduction

Always drive at a steady speed through sand or mud and, do not carry out any manual gear changes or stop the vehicle.

Check whether ESC is active. The indicator lamp  or  in the instrument cluster display must not light up ⇒ Brake support systems .

Keep the vehicle moving constantly.

Use the Offroad driving profile ⇒ Setting a driving profile .

Select a suitable gear and remain in this gear until you have reached more solid ground ⇒ Changing gear correctly .

If the tyres have lost their grip, turn the steering wheel to and fro quickly. This can briefly give the tyres on the front wheels better grip for these ground conditions.

Driving through sand

Do not under any circumstances reduce the tyre pressure to drive through sand ⇒  . If the tyre pressure has been reduced for driving through sand, the correct tyre pressure must always be restored before driving on. Driving with reduced tyre pressure can lead to a loss of control over the vehicle and increase the risk of serious and fatal injuries.

Driving through mud

Do not change speed or direction. The tyres can lose their traction when driving through mud. If the vehicle slides, steer in the direction needed to get the vehicle under control.



WARNING

Driving through mud and sand can be dangerous. The vehicle can slide uncontrollably. This increases the risk of injury. Always drive carefully through sand and mud.

Never choose an unsafe route or take a risk which could endanger you or your passengers. If you are in any doubt about the safety of the route, turn round and choose another way.



WARNING

Incorrect tyre pressure can cause severe or even fatal accidents.

Incorrect tyre pressures will increase the levels of wear on the tyres and will negatively affect the vehicle's handling.

An incorrect tyre pressure can cause overheating, sudden tyre damage including tyre bursts and ripping of the tread surface and thus to a loss of control over the vehicle.

Driving on steep terrain



First read and observe the introductory information and safety warnings ⇒  Introduction

Driving uphill or downhill

Get out of the vehicle and assess the situation before you attempt to drive up or down a hill:

Walk along the section and check the firmness of the ground. Look out for obstacles and other hidden dangers ⇒  .

Check the section beyond the hill.

You should not follow the route if it is too steep, uneven or if the ground surface is too loose. Select another route.

Drive slowly and at constant speed straight up or down a slope.

Accelerate only to the speed you need to climb the slope. Too much acceleration can cause the wheels to spin and lead to a loss of control of the vehicle. Insufficient throttle increases the probability of stalling the engine.

Never attempt to stop or turn on a slope.

Avoid allowing the engine to stall.

Do not change gear or engage the clutch when climbing a slope.

Use the offroad display ⇒ Offroad display .

If you cannot continue to drive up a hill

Never turn the vehicle around on an uphill gradient.

If the engine has stalled, depress the footbrake and start the engine again.

Select reverse gear and reverse back slowly in a straight line.

Use the foot brake to keep a constant speed until you have reached a safe place.

Driving downhill

Never exceed the tilt angle of the vehicle! If, in an emergency, you have to traverse the slope when driving down it and the vehicle threatens to tip over, steer into the fall line immediately.

There is an increased risk of rolling over when driving downhill. Concentrate on steering the vehicle when driving downhill in particular.

Use the offroad display on steep downhill stretches ⇒ Offroad display .

Drive down steep inclines in first gear.

Use the foot brake sparingly in order not to lose control of the vehicle.

If it is possible and safe, drive straight down the slope in the fall line (maximum gradient).

Do not press the clutch and do not select neutral.

 **WARNING**

Never try driving up or down an incline if it is too steep for the vehicle. The vehicle could slide away, tip over or roll.

The uphill or downhill gradient must be no greater than the maximum permissible gradient for the vehicle.

Always drive up and down gradients in the fall line.

Never turn the vehicle when driving up or down gradients. The vehicle could tip over or slide away sideways.

If the engine stops or if you cannot drive on for any reason, stop the vehicle and depress the brake pedal. Start the engine again. Select reverse gear, release the brake pedal and using the engine braking effect to carefully reverse in a straight line along the fall line. Keep the vehicle speed low and constant.

If you are unable to start the engine, keep your foot steady on the brake pedal and allow the vehicle to roll back down the track you made when driving up the hill. Keep the vehicle speed low and constant.

Never let the vehicle roll backwards down a slope in neutral. You could lose control over the vehicle.

Traversing a slope



Fig. 115 Steering into the fall line.

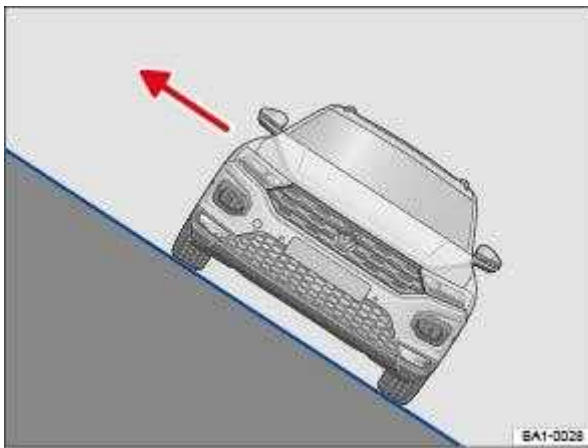

Fig. 116 On steep slopes: always use the doors facing up the hill to get out of the vehicle.



First read and observe the introductory information and safety warnings ⇒ ⚠ Introduction

Traversing a slope is one of the most dangerous offroad situations ⇒ ⚠ .

It may look harmless, but you should not underestimate the difficulty and danger of traversing a slope. A vehicle could slide away, tip over or roll when in this position. This can cause severe or fatal injuries for all vehicle occupants.

Check whether you can use a safer route before driving across a slope.

If you have to drive at an angle, make sure the ground is as firm as possible. The vehicle is more likely to slip and tip over on slippery or soft ground. Always make sure that the tilt angle does not become too large due to uneven ground. The vehicle could otherwise tip over and start to roll.

When the vehicle is tilted at a large angle, the wheels on the lower side of the vehicle must never enter dips or hollows. The wheels on the higher side of the vehicle must never drive over bumps, for example rocks, tree trunks or other obstacles.

If the vehicle threatens to tip over, steer immediately into the fall line and depress the accelerator slightly ⇒ Fig. 115 . If it is not possible to steer into the fall line, then steer uphill and depress the accelerator slightly.

The centre of gravity of the vehicle should be as low as possible. The weight of all vehicle occupants should be evenly distributed. People with a larger or heavier build should sit on the higher side of the vehicle. Remove the roof carrier and secure heavy items. The vehicle could tip over if items were to slide suddenly ⇒ ⚠ .

WARNING

Never try to traverse a slope, particularly if it is too steep for the vehicle. The vehicle could slide away, tip over or roll. Please note the following points in order to reduce the risk of accidents and serious injuries:

You should never underestimate the difficulty and danger of traversing a slope. Never choose an unsafe route or take a risk which could endanger you or your passengers. If you are in any doubt about the safety of the route, turn round and choose another way.

The vehicle can lose its grip when traversing a slope and slide away sideways, tip over or roll over and roll down the hill.

The wheels on the lower side of the vehicle must never enter dips or hollows. The wheels on the higher side of the vehicle must never drive over bumps, for example stones, tree trunks or other obstacles.

Before traversing a slope, make sure that it is possible to steer into the fall line. Choose another route if this is not guaranteed. If the vehicle threatens to tip over, steer immediately into the fall line and depress the accelerator slightly ⇒ Fig. 115 .

If the vehicle is stopped at a large tilt angle when traversing a slope, avoid sudden and uncontrolled movements in the vehicle. The vehicle can lose its grip and slide away sideways, tip over or roll over and roll down the hill.

Vehicle occupants should never leave the vehicle via the doors facing down the hill when the vehicle is stopped sideways on a slope with a large tilt angle to one side. This could cause the centre of gravity to move to the side. The vehicle could then tip over or roll over and roll down the hill. To avoid this, always leave the vehicle carefully on the side that is facing uphill ⇒ Fig. 116 .

When getting out the vehicle, make sure that the vehicle door which opens uphill does not close with its own weight or through carelessness, thus potentially causing injury.

Driving through ditches



First read and observe the introductory information and safety warnings ⇒ Introduction

Check whether the ramp and tilt angles are small enough to drive through the ditch with the vehicle ⇒ .

If possible, drive through the ditch at an acute angle ⇒ .

The tilt angle must not become too large when driving through the ditch.



WARNING

Never drive through a ditch if the ramp and tilt angles are too steep for the vehicle and the ditch is too deep. The vehicle could slide away, tip over or roll.



NOTICE

If you drive into the ditch at a right angle, the front wheels will fall in. The underbody of your vehicle could bottom, get stuck and be damaged. It is then almost impossible to get out of the ditch despite having all-wheel drive.

Stuck vehicle



First read and observe the introductory information and safety warnings ⇒ Introduction

Rocking free a vehicle requires training and feeling for the vehicle.

If you make a mistake when rocking free the vehicle, it can sink deeper and you will need assistance to free the vehicle.

When you cannot move forwards

Carefully dig out all the wheels and check that no other parts of the vehicle are stuck in the sand.

Select reverse gear.

Reverse in your own tracks with gentle use of the accelerator.

If this does not help, place brushwood, foot mats or sacking directly in front of the wheels to increase grip ⇒ ⚠️ .

Rocking the vehicle free

Never allow the wheels to spin for long periods as this will cause the vehicle to sink deeper ⇒ ⚠️ .

Switch off TCS ⇒ Brake support systems .

Position the steering wheel so that it is facing straight ahead.

Reverse until the point where the wheels just start to spin.

Immediately select first gear and drive forwards until the wheels start to spin again.

Repeat driving back and forth until you have enough momentum to free yourself.

Switch the TCS on after the rocking free procedure is completed ⇒ Brake support systems .

Use the Offroad driving profile.

WARNING

No one must stand either in front or behind the vehicle, particularly if you are attempting to free a stuck vehicle.

Spinning wheels can propel stones, brushwood, pieces of wood or other objects that are in front or behind the wheels at enormous speed and cause potentially fatal injury.

People standing in front of or behind the vehicle could be run over if the stuck vehicle starts to move suddenly.

After offroad driving

 First read and observe the introductory information and safety warnings ⇒  Introduction

Checklist



Clean the turn signals, lighting system, the number plate and all windows.



If necessary, remove the towing eye and the snow chains.



Check the tyres, suspension struts and axles for damage and remove dirt, stones and other foreign bodies from the tyre tread.



Inspect the vehicle underbody and remove all items that are jammed in the brake system, on the wheels, in the running gear, in the exhaust system and in the engine, such as branches, leaves or pieces of wood . If you see any damage or leaks, take your vehicle to a qualified workshop or seek expert assistance.



Clean heavy soiling from the radiator grille and the vehicle underbody Vehicle care.



Check the engine compartment to see if any dirt is affecting engine operation In the engine compartment.



Deselecting the Offroad driving profile Setting a driving profile.



Switch on TCS again Brake support systems.

WARNING

Objects caught underneath the vehicle underbody pose a danger. The vehicle underbody must always be examined for trapped objects after every journey offroad.

Never drive if objects are trapped in the underbody, brake system, wheels, running gear, exhaust system and engine.

Inflammable materials, e.g. dry leaves, could ignite on hot vehicle components. A fire can cause serious injuries.

Trapped objects could damage the fuel lines, brake system, seals and other running gear components. This could cause you to lose control of your vehicle and cause accidents.

Driver assist systems

Speed limiter



Introduction

This chapter contains information on the followingsubjects:

⇒ Operating the speed limiter with the multifunction steering wheel

⇒ Troubleshooting

The speed limiter helps you to stop exceeding a stored speed.

Speed range

The speed limiter is available when driving forwards at speeds from approx. 30 km/h (20 mph).

Driving with the speed limiter

You can interrupt the speed limiter at any time by depressing the accelerator all the way down past the point of resistance. As soon as the stored speed is exceeded, the green  indicator lamp will flash and an acoustic warning may sound. The speed remains stored in the memory.

The speed limiter function switches back on automatically as soon as the speed drops back below the stored speed.

Displays

When the speed limiter is switched on, the instrument cluster display shows the stored speed and the status of the speed limiter:



Shown small or grey: speed limiter not active. Shown large or white: speed limiter active.

Driving downhill

Driving downhill may cause the set speed to be exceeded.

Apply the foot brake to slow the vehicle down, and change down a gear as required.



WARNING

Always switch off the speed limiter after use to avoid unintentional speed control.

The speed limiter does not relieve the driver of their responsibility for the speed of the vehicle. Do not drive at full throttle if this is not required.

Use of the speed limiter in adverse weather conditions is dangerous and can cause serious injury, e.g. through aquaplaning, snow, ice, or leaves. Use the speed limiter only when the road and weather conditions allow it to be used safely.

The speed limiter cannot limit the vehicle speed when travelling downhill. The vehicle speed can increase under its own weight. Select a lower gear or use the foot brake to slow the vehicle down.

Operating the speed limiter with the multifunction steering wheel



Fig. 117 Left-hand side of the multifunction steering wheel: buttons for operating the speed limiter.

First read and observe the introductory information and safety warnings ⇒ Introduction

Switching on

Press the button.

The speed last set remains stored. There is no control yet.

Starting control

While driving, press the **SET** button.

The current speed is stored as the maximum speed. The green indicator lamp .

Setting the speed

You can adjust the stored speed:

RES + 1 km/h (1 mph) **SET** - 1 km/h (1 mph) **+** + 10 km/h (5 mph) **-** - 10 km/h (5 mph)

To continuously adjust the stored speed, press and hold the button **+** or **-**.

Interrupting control

Press the button.

The speed remains stored in the memory.

Resuming control

Press the **RES** button.

The speed limiter is automatically reactivated as soon as the current speed is lower than the stored speed.

Switching off

Press and hold the button.

The speed limiter is switched off, the speed remains stored (even after the ignition is switched off).

Changing to Adaptive Cruise Control (ACC)

Press the  button.

The speed limiter is switched off.

Troubleshooting



First read and observe the introductory information and safety warnings ⇒  Introduction

Control is automatically interrupted.

Malfunction. Switch off the speed limiter and go to a qualified workshop.

For safety reasons, the speed limiter does not fully deactivate itself until you release the accelerator once or switch the system off manually.

Adaptive Cruise Control (ACC)



Introduction

This chapter contains information on the following subjects:

⇒ Special driving situations

⇒ Limits of ACC

⇒ Switching ACC on and off

⇒ Setting ACC

⇒ Troubleshooting

The Adaptive Cruise Control (ACC) maintains a speed selected by the driver. If the vehicle approaches a vehicle in front, the ACC automatically adapts the speed so that a distance you have selected is maintained.

Speed range

ACC controls the vehicle in the speed range between 30 km/h (20 mph) and 160 km/h (100 mph) or 210 km/h (130 mph). This speed range may differ in certain markets.

Driving with ACC

You can override the ACC at any time. Control will be interrupted when you brake. If you accelerate, control will be interrupted for the duration of the acceleration process and will then continue again.

Control by ACC is less dynamic when towing a trailer ⇒ . The ACC will not perform control operation if the trailer's brake lights are faulty.

Does the vehicle have ACC?

The vehicle is equipped with ACC if you can make settings for ACC in the vehicle settings of the Infotainment system ⇒ Vehicle settings menu .

Brake request

If automatic deceleration by ACC is not sufficient, ACC will request you to brake additionally by a corresponding message on the instrument cluster. In addition, the red warning lamp  lights up and an acoustic warning is given. Brake immediately!

Radar sensor

ACC detects driving situations by means of the radar sensor at the front of the vehicle ⇒ Front view .

The radar sensor has a range of up to approximately 120 m.

WARNING

The intelligent technology used in the ACC cannot overcome the laws of physics, and functions only within the limits of the system. Never let the extra convenience tempt you into taking safety risks when driving. Careless or unintentional use of the Adaptive Cruise Control (ACC) can cause accidents and lead to serious injury. The system is not a substitute for the full concentration of the driver.

Adapt your speed and distance from the vehicles ahead to suit visibility, weather, road and traffic conditions.

Never use the ACC in poor visibility, on steep or winding roads, or on slippery road surfaces e.g. due to snow, ice, wet roads, loose chippings, or on flooded roads.

Never use the ACC offroad or on non-surfaced roads. The ACC is designed for use on surfaced roads only.

The ACC will not react to stationary vehicles.

The ACC will not react to persons, animals or vehicles crossing or approaching in the same lane.

Brake immediately if speed reduction by ACC is not sufficient.

Brake immediately if a request to brake appears on the instrument cluster display.

Brake if the vehicle starts rolling unintentionally after a request to brake.

Be prepared to control the speed yourself at all times.

Special driving situations

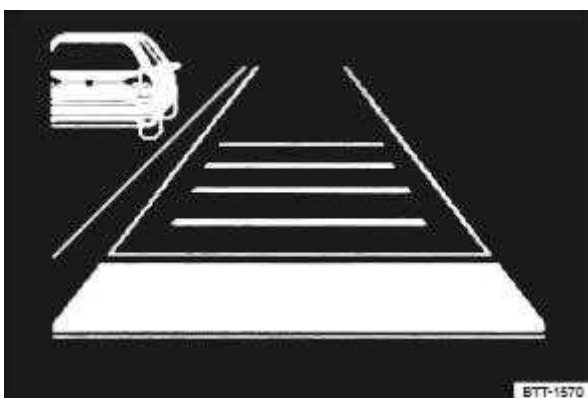

Fig. 118 On the instrument cluster display: slower vehicle detected in the left-hand lane (illustration).



First read and observe the introductory information and safety warnings ⇒ Introduction

Overtaking

If you indicate left (left-hand traffic: indicate right) to overtake, ACC will accelerate the vehicle and reduce the distance from the vehicle in front. Your set speed will not be exceeded.

If ACC does not detect any vehicle in front after you have changed lane, ACC will accelerate the vehicle up to the set speed.

Stop-and-go traffic

ACC can brake vehicles with DSG® dual clutch gearbox to a standstill and hold them stationary. ACC remains active and the instrument cluster display shows ACC ready for a few seconds. During this time the vehicle will move off again automatically as soon as the vehicle in front moves off (depending on the vehicle equipment level and not available in all countries).

Press the **RES** button.

Press the **RES** button or briefly press the accelerator.

The vehicle is stationary for longer than approximately three minutes.

A vehicle door is opened.

The ignition is switched off.

Avoiding overtaking on the right (left-hand traffic: overtaking on the left)

If ACC detects a slower vehicle in the left-hand lane (left-hand traffic: in the right-hand lane), ACC will brake the vehicle gently within the system limits and therefore prevent a prohibited overtaking manoeuvre ⇒ Fig. 118 . The function is active from speeds of around 80 km/h (50 mph), but is not available in all countries.



WARNING

If the message ACC ready is shown on the instrument cluster display and the vehicle in front moves off, your vehicle will move off automatically. In some cases the radar sensor may be unable to detect obstacles that are located in the vehicle's path. This can result in serious injury and accidents.

Always check the road ahead before moving off and brake the vehicle if necessary.

Limits of ACC

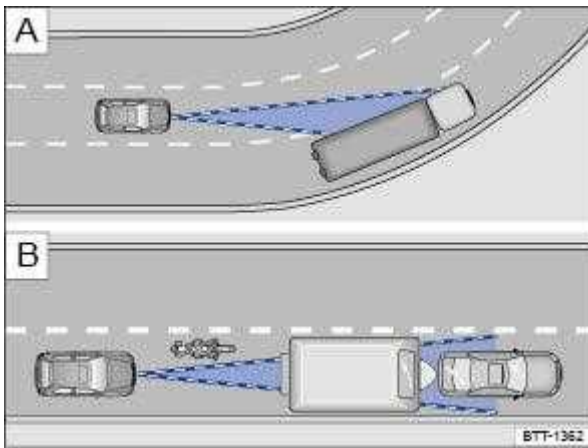

Fig. 119 Driving through bends. Vehicles outside the range of the radar sensor.

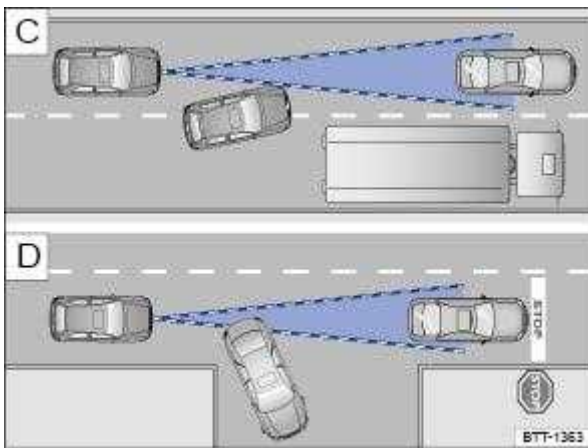

Fig. 120 Vehicle changes lane. Turning vehicle and stationary vehicle.



First read and observe the introductory information and safety warnings ⇒ ⚠ Introduction

When not to use ACC

Driving in heavy rain, snow or heavy spray.

Driving through tunnels.

Driving through road works.

Driving on twisting roads, e.g. mountain roads.

Driving offroad.

Driving in multi-storey car parks.

Driving on roads with embedded metal objects, e.g. railway tracks.

Driving on roads with loose chippings.

Vehicles without inside overtaking prevention function: driving on multi-lane roads when vehicles in the overtaking lane are driving more slowly.

Delayed response

If the radar sensor is exposed to environmental conditions that impair sensor functioning, the system may detect this only after a certain time. For this reason, possible functional restrictions may be displayed only after a delay at the start of the journey and when driving ⇒ ⚠ .

Objects that cannot be detected

Persons.

Animals.

Stationary vehicles.

Crossing or oncoming vehicles.

Other stationary obstacles.

If a stationary vehicle is hidden behind a vehicle that has been detected by the adaptive cruise control and this vehicle turns off the road or changes lane, the ACC will not react to the stationary vehicle ⇒ Fig. 120 **D**.

Bends

The radar sensor always measures straight ahead. For this reason, vehicles may be incorrectly detected or vehicles driving ahead not detected in tight bends ⇒ Fig. 119 **A**.

Vehicles outside the sensor range

Vehicles that are driving outside the sensor range in close proximity to your vehicle, e.g. motorbikes ⇒ Fig. 119 **B**.

Vehicles that change into your lane directly in front of your vehicle ⇒ Fig. 120 **C**.

Vehicles with bodies or attachments that project beyond the vehicle.

⚠ WARNING

If you use ACC in the above situations, this can result in accidents and serious injuries as well as violation of legal regulations.

Switching ACC on and off



Fig. 121 Left-hand side of the multifunction steering wheel: buttons for operating ACC.



First read and observe the introductory information and safety warnings ⇒ Introduction

Switching on ACC

Press the button.

The indicator lamp lights up grey, ACC does not regulate.

Starting control

Press the **SET** button while driving forwards.

ACC stores the current speed and maintains the set distance. If the current speed is outside the defined speed range, ACC will set the minimum speed (when driving more slowly than the limit) or maximum speed (when driving faster than the limit).

The following indicator lamps light up, depending on the driving situation:

ACC regulating. No vehicle has been detected ahead. Vehicle detected ahead (white).

Interrupting control

Briefly press the button or press the brake pedal.

The indicator lights up grey, the speed and distance remain stored.

Control is automatically interrupted if the traction control system (TCS) is deactivated.

Resuming control

Press the **RES** button.

ACC adopts the last set speed and last set distance. The instrument cluster display shows the set speed and the indicator lamp lights up green.

Switching off ACC

Press and hold the button.

The set speed is deleted.

Changing to the speed limiter

Press the button.

ACC is switched off.

Setting ACC

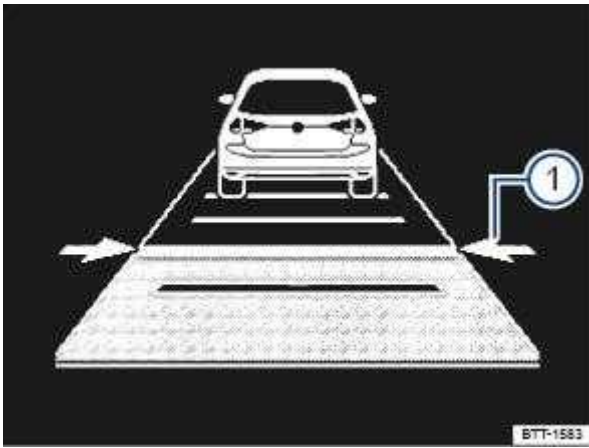



Fig. 122 On the instrument cluster display: setting the distance (illustration, ACC regulating).

 First read and observe the introductory information and safety warnings ⇒  Introduction

Setting the distance

You can set the distance in five steps from very small to very large:

Press the  button and then the **+** or **-** button.

Alternatively, press the  button as often as necessary until the desired distance is set.

The instrument cluster display shows the chosen distance setting ⇒ Fig. 122 ① . Please observe any country-specific requirements for the minimum distance.

You can set the distance which should be set at the start of control operation in the vehicle settings of the Infotainment system ⇒ Vehicle settings menu .

If ACC is not regulating, the set distance and vehicle are not highlighted on the instrument cluster display.

Setting the speed

You can adjust the stored speed within the defined speed range by means of the buttons on the multifunction steering wheel:

RES + 1 km/h (1 mph) **SET** - 1 km/h (1 mph) **+** + 10 km/h (5 mph) **-** - 10 km/h (5 mph)

Press and hold the corresponding button to continuously change the stored speed.

Setting the control behaviour

Vehicles with driving profile selection: set the desired driving profile ⇒ Driving profile selection and 4MOTION Active Control .

Vehicles without driving profile selection: set the desired gearbox programme in the vehicle settings of the Infotainment system ⇒ Vehicle settings menu .

WARNING

If you do not maintain the minimum distance to a vehicle in front and the difference in speed between the vehicle in front and your own vehicle is so great that the braking action of the ACC is insufficient, you are in danger of colliding with the vehicle in front. The braking distance is also longer in rain and winter road conditions.

ACC may not be able to detect all driving situations correctly.

Always be prepared to brake the vehicle yourself.

Speed and distance control are overridden when you press the accelerator. ACC does not brake automatically in this case.

Observe any country-specific regulations relating to the minimum distance.

Always set a larger distance in wet or snowy conditions or when visibility is poor.



Some settings can be stored in the user accounts of the personalisation function and therefore change automatically when the user account changes ⇒ Personalisation .

Troubleshooting



First read and observe the introductory information and safety warnings ⇒  Introduction



!ACC not available.

The indicator lamp lights up yellow.

The radar sensor is dirty. Clean the radar sensor ⇒ Vehicle care .

The visibility of the radar sensor is impaired due to the weather conditions, e.g. snow, or due to detergent deposits or coatings. Clean the radar sensor ⇒ Vehicle care .

The visibility of the radar sensor is impaired by add-on parts, the trim frames of number plate holders or stickers. Keep the area around the radar sensor free.

The radar sensor has been displaced or damaged, e.g. due to damage to the front of the vehicle. Check whether damage is visible ⇒ Repairs and technical modifications .

Fault or malfunction. Switch off and restart the engine.

Structural modifications have been made to the front of the vehicle.

The genuine Volkswagen badge is not used.

If the problem persists, go to a qualified workshop.

ACC does not function as expected.

The radar sensor is dirty. Clean the radar sensor ⇒ Vehicle care .

The system limits are not met ⇒ Limits of ACC .

The brakes have overheated, control was interrupted automatically. Allow the brakes to cool down and check functioning again.

If the problem persists, go to a qualified workshop.

Control cannot be started.

A forward gear other than first gear is selected (manual gearbox) or the selector lever is in selector lever position D/S or the Tiptronic gate.

The speed is at least 25 km/h (16 mph) in the case of vehicles with manual gearbox.

The brake lights on the vehicle and trailer ⇒ are working.

ESC is not regulating.

The brake pedal is not depressed.

Unusual noises during automatic braking.

This is normal and is not a fault.

Area monitoring system (Front Assist)



Introduction

This chapter contains information on the following subjects:

⇒ Warning levels and braking intervention

⇒ Limits of Front Assist

⇒ Pedestrian Monitoring

⇒ Operating the area monitoring system (Front Assist)

⇒ Troubleshooting

The area monitoring system (Front Assist) with City Emergency Braking System and Pedestrian Monitoring can help to avoid accidents.

Within the limits of the system, Front Assist can warn the driver about imminent collisions, prepare the vehicle for emergency braking, assist with braking, and initiate automatic braking. The warning time varies depending on the traffic situation and driver behaviour.

Front Assist is not a substitute for the full concentration of the driver.

Driving with Front Assist

You can cancel the automatic braking interventions of Front Assist by steering or pressing the accelerator.

Automatic braking

Front Assist can decelerate the vehicle to a standstill. The vehicle will then not be held permanently. Depress the brake pedal.

The brake pedal will feel harder during an automatic braking operation.

Radar sensor

Front Assist detects driving situations by means of the radar sensor at the front of the vehicle
⇒ Front view . The radar sensor has a range of up to approximately 120 m.

Functions included in the system

The City Emergency Braking System and Pedestrian Monitoring (depending on vehicle equipment) are part of Front Assist and are automatically active when Front Assist is switched on.

WARNING

The intelligent technology used in Front Assist cannot overcome the laws of physics, and functions only within the limits of the system. Never let the extra convenience afforded by Front Assist tempt you into taking safety risks when driving. The driver is always responsible for braking in time.

If Front Assist issues a warning, brake your vehicle immediately depending on the traffic situation or avoid the obstacle.

Adapt your speed and distance from the vehicles ahead to suit visibility, weather, road and traffic conditions.

Front Assist cannot prevent accidents and serious injuries on its own.

Front Assist can issue unnecessary warnings and carry out unwanted braking interventions in certain complex driving situations, e.g. at traffic islands.

Front Assist can issue unnecessary warnings and carry out unwanted braking interventions when its function is impaired, e.g. if the radar sensor is dirty or its position has been changed.

Front Assist without Pedestrian Monitoring does not react to persons. In addition, the system does not react to animals or to vehicles that are crossing or approaching in the same lane.

If you are unsure whether your vehicle possesses Pedestrian Monitoring, please enquire about this at a qualified workshop before starting your journey.

Be prepared to take over control of the vehicle yourself at all times.

Warning levels and braking intervention

 First read and observe the introductory information and safety warnings ⇒  Introduction

Distance warning 

The system detects when safety is endangered by driving too close to the vehicle in front. The warning lamp  lights up. Increase the distance.

Speed range: around 65 km/h (40 mph) to 250 km/h (155 mph).

Advance warning 

The system is able to detect possible collisions with vehicles in front or pedestrians crossing in front of the vehicle and prepares the vehicle for a possible emergency braking procedure.

A warning tone sounds and the red warning lamp  lights up. Brake or take avoiding action.

Speed range: around 30 km/h (20 mph) to 250 km/h (155 mph).

Urgent warning

If the driver does not react to the advance warning, the system may initiate a short braking jolt in order to draw attention to the increasing collision risk. Brake or take avoiding action.

Speed range: around 30 km/h (20 mph) to 250 km/h (155 mph).

Automatic braking

If the driver also does not react to the urgent warning, the vehicle can be braked automatically with braking force that increases in several stages. The reduced speed means that it is possible to minimise the consequences of an accident.

Speed range: around 5 km/h (3 mph) to 250 km/h (155 mph).

Braking intervention

If the system detects that the driver is braking insufficiently when there is a risk of collision, the system can increase the braking force and help prevent a collision. The braking intervention takes place only for as long as the brake pedal is pressed hard.

Speed range: around 5 km/h (3 mph) to 250 km/h (155 mph).

City Emergency Braking System

The City Emergency Braking System is part of Front Assist. If the driver does not react to a possible collision, the system can also automatically brake the vehicle with increasing braking force without any advance warning.

The red warning lamp lights up .

Speed range: around 5 km/h (3 mph) to 30 km/h (20 mph).

Limits of Front Assist



First read and observe the introductory information and safety warnings ⇒  Introduction

Front Assist is not available or its functions are restricted for a period of around 30 seconds (also longer, depending on the driving situation) immediately after the vehicle is started.

Front Assist has physical and system-related limitations. You should therefore always be prepared to take full control of the vehicle if necessary.

Delayed response

If the radar sensor is exposed to environmental conditions that impair sensor functioning, the system may detect this only after a certain time. For this reason, possible functional restrictions may be displayed only after a delay at the start of the journey and when driving ⇒ .

Objects that cannot be detected

Vehicles that are driving outside the sensor range in close proximity to your vehicle, e.g. vehicles that are driving offset to your vehicle or motorbikes.

Vehicles that change into your lane directly in front of your vehicle.

Vehicles with bodies or attachments that project beyond the vehicle.

Oncoming vehicles or vehicles crossing your path.

Pedestrians who are stationary, moving towards the vehicle or moving in the same direction as the vehicle.

Function limitations

In tight bends.

Driving in heavy rain, snow or heavy spray.

Driving in multi-storey car parks.

Driving on roads with embedded metal objects, e.g. railway tracks.

Reversing.

If TCS is switched off manually.

If ESC is taking corrective action.

If the radar sensor is dirty or covered.

If there is a fault in several brake lights on the vehicle or on a trailer with an electrical connection to the vehicle ⇒ .

If the vehicle accelerates hard or the accelerator is fully depressed.

In complex driving situations, e.g. at traffic islands.

In unclear traffic situations, e.g. vehicles ahead are braking heavily or turning off.

If there is a fault in Front Assist.

Switching off Front Assist

If the vehicle is used in a capacity other than driving in normal traffic, e.g. offroad.

If the vehicle is being towed or is loaded onto another vehicle.

If the radar sensor is covered temporarily by add-on parts, e.g. auxiliary headlights.

If the radar sensor is faulty.

After external force on the radar sensor, e.g. after a frontal collision.

In the event of multiple unwanted interventions.

WARNING

Failure to switch off Front Assist in the situations mentioned can result in accidents and serious injuries.

Pedestrian Monitoring

 First read and observe the introductory information and safety warnings ⇒  Introduction

Pedestrian Monitoring can help to avoid accidents with pedestrians crossing the vehicle's path or to mitigate the consequences of an accident.

The system gives a warning when there is a risk of collision, prepares the vehicle for emergency braking, helps to brake the vehicle or performs an automatic brake intervention. In the event of an advance warning, the warning lamp lights up in the instrument cluster 

When Front Assist is switched on, Pedestrian Monitoring is active as part of Front Assist in a vehicle speed range from approx. 5 km/h (3 mph) to 65 km/h (40 mph).

Pedestrian Monitoring is not available in all countries, depending on the vehicle equipment level.

WARNING

The intelligent Pedestrian Monitoring technology cannot overcome the laws of physics, and functions only within the limits of the system. Never let the extra convenience afforded by the Pedestrian Monitoring system tempt you into taking any safety risks when driving. The driver is always responsible for braking in time.

If Pedestrian Monitoring issues a warning, brake your vehicle immediately depending on the traffic situation or avoid the pedestrian.

Pedestrian Monitoring cannot prevent accidents and serious injuries on its own.

Pedestrian Monitoring can issue unnecessary warnings and carry out unwanted braking interventions in complex driving situations, e.g. on a main road that turns sharply.

Pedestrian Monitoring can issue unnecessary warnings and carry out unwanted braking interventions when its function is impaired, e.g. if the radar sensor is covered or its position has been changed.

Be prepared to take over control of the vehicle yourself at all times.

Operating the area monitoring system (Front Assist)

 First read and observe the introductory information and safety warnings ⇒  Introduction

Front Assist and the advance warning (in some countries) are automatically switched on when you switch on the ignition.

However, the system is not available or its functions are restricted for a period of around 30 seconds (also longer, depending on the driving situation).

Volkswagen recommends that Front Assist and also the distance and advance warnings are switched on at all times. Exceptions ⇒ Limits of Front Assist .

Switching on and off

Switch Front Assist on and off in the vehicle settings of the Infotainment system ⇒ Vehicle settings menu .

Or: switch Front Assist on and off in the instrument cluster menus ⇒ Instrument cluster menus .

If you switch off Front Assist, the advance warning and distance warning will also be switched off.

The yellow indicator lamp lights up in the instrument cluster display. .

Setting the distance and advance warnings

Switch on Front Assist.

Switch the desired function on and off in the vehicle settings of the Infotainment system ⇒ Vehicle settings menu .

Depending on the vehicle equipment, you can also set the warning time for the advance warning.



Some settings can be stored in the user accounts of the personalisation function and therefore change automatically when the user account changes ⇒ Personalisation .

Troubleshooting



First read and observe the introductory information and safety warnings ⇒ Introduction

Front Assist is not available, the radar sensor does not have sufficient visibility.

The radar sensor is dirty. Clean the radar sensor ⇒ Vehicle care .

The visibility of the radar sensor is impaired due to the weather conditions, e.g. snow, or due to detergent deposits or coatings. Clean the radar sensor ⇒ Vehicle care .

The visibility of the radar sensor is impaired by add-on parts, the trim frames of number plate holders or stickers. Keep the area around the radar sensor free.

The radar sensor has been displaced or damaged, e.g. due to damage to the front of the vehicle. Check whether damage is visible ⇒ Repairs and technical modifications .

Structural modifications have been made to the front of the vehicle.

The genuine Volkswagen badge is not used.

If the problem persists, switch off Front Assist and go to a qualified workshop.

Front Assist does not function as expected or is triggered unnecessarily several times.

The radar sensor is dirty. Clean the radar sensor ⇒ Vehicle care .

The system limits are not met ⇒ Limits of Front Assist .

If the problem persists, switch off Front Assist and go to a qualified workshop.

Lane keeping system (Lane Assist)



Introduction

This chapter contains information on the following subjects:

⇒ Driving with the lane keeping system

⇒ Troubleshooting

The lane keeping system (Lane Assist) helps the driver stay in lane.

Using a camera in the windscreen, the lane departure warning system detects lane markings on the road. If your vehicle moves too close to a recognised lane marking, the system will warn the driver with a corrective steering intervention. The corrective steering intervention can be overridden by the driver at any time.

Adaptive lane guidance (depending on vehicle equipment)

The adaptive lane guidance system detects the preferred position in a lane and keeps the vehicle in this position.

Adaptive lane guidance is switched on and off in the Driver assistance menu in the Infotainment system ⇒ Vehicle settings menu .

System limits

Use the lane keeping system only on motorways and good main roads.

The system is not active under the following conditions:

The lane keeping system has not detected any lane markings.



WARNING

The intelligent technology used in the lane keeping system cannot overcome the laws of physics, and functions only within the limits of the system. Always take care when using the lane departure warning system otherwise you could cause accidents or injuries. The system is not a substitute for the full concentration of the driver.

Adapt your speed and distance from the vehicles ahead to suit visibility, weather, road and traffic conditions.

Your hands should always be on the steering wheel so that you can steer at any time. The driver is always responsible for staying in lane.

The lane keeping system cannot recognise all lane markings. Poor road surfaces, road structures or objects could be recognised incorrectly as lane markings by the lane keeping system. The lane keeping system should be switched off immediately in these situations.

Follow the information on the instrument cluster display and respond according to the commands.

Always pay close attention to the surroundings of the vehicle.

If the camera's field of view is dirty, covered or damaged, the function of the lane keeping system may be impaired.



Some settings can be saved in the user accounts of the personalisation function and can therefore change automatically when the user account is changed ⇒ Personalisation .

Driving with the lane keeping system

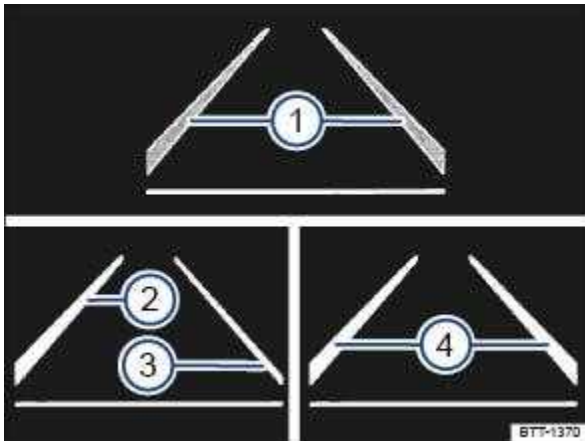

Fig. 123 On the instrument cluster display: lane keeping system displays.





First read and observe the introductory information and safety warnings ⇒ Introduction

Switching the lane keeping system on and off

Using the button for the driver assist systems, select the corresponding menu option ⇒ Button for driver assist systems .

OR: in the Driver assistance menu in the Infotainment system ⇒ Vehicle settings menu .

If the indicator lamp  lights up yellow in the instrument cluster display, the lane keeping system is switched on but is not active.

The lane keeping system is active at speeds above approximately 65 km/h (40 mph) when lane markings can be identified ⇒ System limits . The indicator lamp  lights up green.

Displays

Display areas in the instrument cluster display ⇒ Fig. 123 :

- ① Lane markings detected. System not regulating.
- ② Lane markings detected. System is regulating.
- ③ No lane markings detected. System not regulating.
- ④ Lane markings detected. System is regulating. Adaptive lane guidance active.

Temporarily switching off the lane keeping system

Switch off the lane keeping system in the following situations:

Very sporty driving.

In poor weather conditions and when driving on poor roads.

In roadworks and before crests in the road.

Driver intervention prompt

In the absence of any steering input, the system prompts the driver with acoustic warnings and a display on the instrument cluster display to take over active steering.

If the driver does not respond, the system will give another warning by initiating a quick jolt of the brake before switching to passive mode or activating Emergency Assist (with some equipment levels).

Steering wheel vibration

The following situations can lead to vibration of the steering wheel:

If the corrective steering intervention is not sufficient to keep the vehicle in its lane.

If the system can no longer detect a lane during a significant steering intervention.



If there is a system fault, the lane keeping system can deactivate itself automatically.

Troubleshooting



First read and observe the introductory information and safety warnings ⇒  Introduction

No camera visibility, error message, system switches itself off

Clean the windscreen ⇒ Caring for and cleaning the vehicle exterior .

Check whether any damage is visible on the windscreen in the camera's field of view.

The system is not responding as expected

Regularly clean the camera's field of view, and keep it free from snow and ice.

Do not cover the camera's field of view.

Check the area of the windscreen that is in the camera's field of view for damage.

Do not fit any objects to the steering wheel.

Traffic Jam Assist

Traffic Jam Assist helps the driver to keep in lane, and also provides assistance when following other vehicles in congestion or slow-moving traffic.

Traffic Jam Assist is an extension of the lane keeping system (Lane Assist) for vehicles with DSG[®] and combines its functions with the Adaptive Cruise Control (ACC). Please therefore read both these chapters and observe the information about the system limits and warnings.

Traffic Jam Assist function

Traffic Jam Assist can maintain a time interval set by the driver to a vehicle in front and help the vehicle to stay in lane ⇒  .

The system automatically controls acceleration, braking, steering and, if required, will decelerate to a stop behind a vehicle that is stopping, and then pull away again automatically.

Use Traffic Jam Assist only on motorways and good main roads. Do not use Traffic Jam Assist in urban traffic.

Switching Traffic Jam Assist on and off

Traffic Jam Assist is switched on and off together with the adaptive lane guidance of the lane keeping system in the Infotainment system ⇒ Vehicle settings menu .

Traffic Jam Assist can also be switched off together with the lane keeping system via the button for driver assist systems ⇒ Button for driver assist systems .

Technical requirements for using Traffic Jam Assist

The lane keeping system is switched on and active together with adaptive lane guidance ⇒ Driving with the lane keeping system .

Adaptive Cruise Control (ACC) is switched on and active ⇒ Switching ACC on and off .

The selector lever is in position D/S or in the Tiptronic gate.

The system has detected a lane marking on both the right and left sides of the vehicle ⇒ Fig. 123  .

The speed is under 60 km/h (35 mph).

Traffic Jam Assist is not active (indicator lamp for the lane keeping system lights up yellow)

As soon as one of the conditions indicated in ⇒ Technical requirements for using Traffic Jam Assist is no longer fulfilled.

If one of the conditions for the proper functioning of the lane keeping system is no longer fulfilled ⇒ .

If one of the conditions for the proper functioning of the Adaptive Cruise Control (ACC) is no longer fulfilled ⇒ Limits of ACC .

Switch off Traffic Jam Assist in the following situations

Traffic Jam Assist should always be switched off in the following situations due to system limitations:

When a high level of concentration is required by the driver.

Very sporty driving.

In poor weather conditions, e.g. snow or heavy rain.

Poor road conditions.

Driving through road works.

In urban areas.



The intelligent technology of Traffic Jam Assist cannot overcome the laws of physics, and functions only within the limits of the system. Always take care when using Traffic Jam Assist as you could otherwise cause accidents or injuries. The system is not a substitute for the full concentration of the driver.

Adapt your speed and distance from the vehicles ahead to suit visibility, weather, road and traffic conditions.

Do not use Traffic Jam Assist in urban traffic.

Do not use Traffic Jam Assist in poor visibility, on steep or winding roads, or on slippery road surfaces e.g. on snow, ice, wet roads, loose chippings or flooded roads.

Never use Traffic Jam Assist offroad or on unsurfaced roads. Traffic Jam Assist is designed solely for use on surfaced roads.

Traffic Jam Assist does not react to persons, animals or vehicles crossing or approaching in the same lane.

If the speed reduction achieved by Traffic Jam Assist is insufficient, brake the vehicle immediately by depressing the foot brake.

If the vehicle starts to roll unintentionally after the driver has been prompted to take control of the vehicle, brake the vehicle immediately using the foot brake.

If a driver intervention prompt appears on the instrument cluster display, take control of the vehicle immediately.

Your hands should always be on the steering wheel so that you can steer at any time. The driver is always responsible for staying in lane.

The driver must be prepared to take control of the vehicle (by accelerating or braking) at all times.



If Traffic Jam Assist does not function as described in this chapter, do not use the system and go to a qualified workshop.



If there is a fault in the system, visit a qualified workshop and have the system checked.

Semi-automatic vehicle control in a medical emergency (Emergency Assist)

Emergency Assist detects a lack of activity on the part of the driver and can keep the vehicle in lane automatically, or brake the vehicle to a standstill if required. The system can therefore actively help to prevent an accident.

Emergency Assist is an extension of the lane keeping system (Lane Assist), and combines these functions with the Adaptive Cruise Control (ACC). Please therefore read both these chapters and observe the information about the system limits and warnings.

Description

If there is no driver activity, Emergency Assist prompts the driver to take control of the vehicle again by visual and acoustic warnings and by braking jolts.

If the driver remains inactive, the system automatically controls the accelerator, brake and steering to slow the vehicle down and keep it in lane ⇒  . If there is sufficient stopping distance, the system decelerates the vehicle to a complete stop and switches on the electronic parking brake automatically ⇒ Operating the electronic parking brake .

When Emergency Assist is actively controlling the vehicle, the hazard warning lights are switched on and the vehicle performs slight snaking movements within its lane to warn other road users.

The hazard warning lights can be deactivated by pressing the accelerator or brake, by making a steering intervention or, depending on the situation, by pressing the button for the hazard warning lights.

When Emergency Assist has been triggered, the system is not available again until the ignition has been switched off and then back on.

Prerequisites

The lane keeping system and ACC are switched on.

The selector lever is in position D/S or in the Tiptronic gate.

The system has detected a lane marking on both the right and left sides of the vehicle ⇒ Fig. 123 .

Switching Emergency Assist on and off

Emergency Assist is activated automatically when the lane keeping system ⇒ Driving with the lane keeping system is switched on.

WARNING

The intelligent technology used in Emergency Assist cannot overcome the laws of physics, and functions only within the limits of the system. The driver is always responsible for controlling the vehicle.

Adapt your speed and distance from the vehicles ahead to suit visibility, weather, road and traffic conditions.

Your hands should always be on the steering wheel so that you can steer at any time.

Emergency Assist cannot always prevent accidents and serious injuries on its own.

If the radar sensor for the Adaptive Cruise Control (ACC) or the camera for the lane keeping system is covered or moved, Emergency Assist may make unwanted braking or steering manoeuvres.

Emergency Assist does not react to persons, animals or vehicles crossing or approaching in the same lane.

WARNING

If Emergency Assist is triggered unnecessarily, this can result in accidents and serious injuries.

If there is a malfunction in the Emergency Assist system, switch off the lane keeping system (Lane Assist) ⇒ Driving with the lane keeping system . This will also switch off Emergency Assist.

Go to a qualified workshop and have the system checked. Volkswagen recommends using a Volkswagen dealership for this purpose.

Blind Spot Monitor

Introduction

This chapter contains information on the following subjects:

⇒ Driving with the Blind Spot Monitor

⇒ Troubleshooting

Radar sensors monitor the area behind the vehicle. The system measures the distance and difference in speed in relation to other vehicles and uses visual signals in the exterior mirrors to inform the driver.

System limits

Use the Blind Spot Monitor only on surfaced roads.

The Blind Spot Monitor may not always interpret the traffic correctly in the following situations:

In tight bends.

When driving in the middle of two lanes.

When road lanes are of varying width.

At road crests.

In poor weather conditions.

Where there are special roadside structures, e.g. high or offset crash barriers.

WARNING

The intelligent technology used in the Blind Spot Monitor cannot overcome the laws of physics, and functions only within the limits of the system. Never let the extra convenience afforded by the Blind

Spot Monitor tempt you into taking any safety risks when driving. Careless or unintentional use of the Blind Spot Monitor can cause accidents and serious injuries. The system is not a substitute for the full concentration of the driver.

Adapt your speed and distance from the vehicles ahead to suit visibility, weather, road and traffic conditions.

Your hands should always be on the steering wheel so that you can steer at any time.

Pay attention to the indicator lamps in the exterior mirrors and in the instrument cluster display and respond according to the commands.

Always pay close attention to the surroundings of the vehicle.

Never use the Blind Spot Monitor if the radar sensors are dirty, covered or damaged. These conditions can impair the proper functioning of the system.

It may be hard to see the indicator lamp in the exterior mirror in direct sunlight.



Some settings can be saved in the user accounts of the personalisation function and can therefore change automatically when the user account is changed ⇒ Personalisation .

Driving with the Blind Spot Monitor

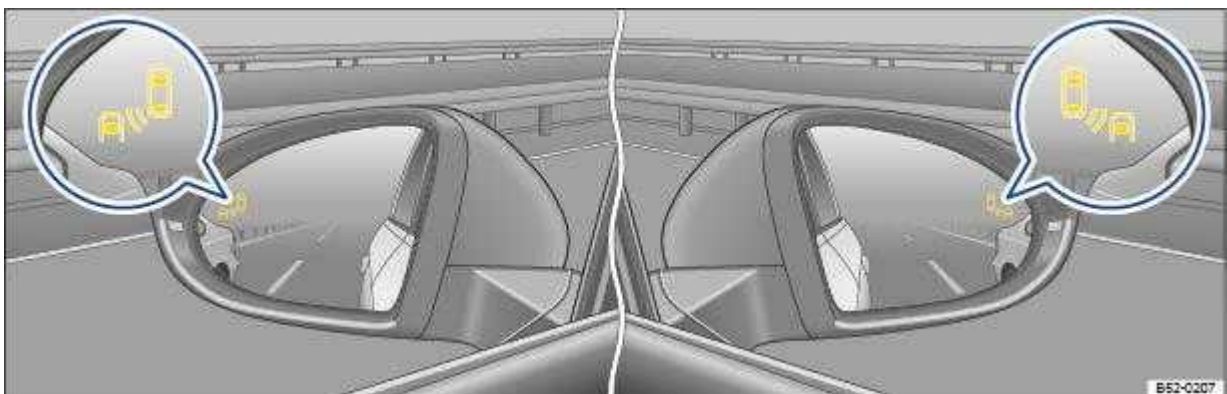

Fig. 124 In the exterior mirrors: Blind Spot Monitor display.



First read and observe the introductory information and safety warnings ⇒ Introduction

Switching on and off

Depending on the vehicle equipment, by means of the button for the driver assist systems ⇒ Button for driver assist systems .

OR: using the Assist systems menu in the instrument cluster.

OR: with some equipment levels, in the Driver assistance menu in the Infotainment system ⇒ Vehicle settings menu .

When the Blind Spot Monitor is ready for operation, the yellow indicator lamp  lights up once briefly in the exterior mirrors.

This most recent system setting is retained even after the ignition has been switched off and on.



Function

When switched on, the Blind Spot Monitor is active from a speed of approx. 15 km/h (9 mph).

In the following driving situations, the yellow indicator lamp will light up in the corresponding exterior mirror:  ⇒ Fig. 124

If your vehicle is being overtaken.

When overtaking another vehicle with a speed difference of up to approximately 10 km/h (6 mph). No display will be shown if the takeover manoeuvre is much faster.

If a vehicle is detected in the blind spot and the turn signal is additionally activated in the direction of the detected vehicle ⇒ , the yellow indicator lamp will flash. 

In vehicles with the lane keeping system, the yellow indicator lamp  will flash even if you do not activate the turn signal when leaving your lane, provided that the lane keeping system is switched on (Blind Spot Monitor Plus). The driver is warned by a corrective steering intervention when changing lanes during a possible critical situation (information level, warning level). This also occurs when the turn signal is activated for the corresponding direction. If the steering intervention is overridden by the driver, the steering wheel vibrates to give an additional warning.

The quicker another vehicle approaches, the earlier there is a corresponding display in the exterior mirror.

Automatic deactivation

The radar sensors for the Blind Spot Monitor will switch off automatically if, for example, the system detects that a radar sensor is continuously covered. This can be caused by a layer of ice or snow in front of the radar sensor, for example.

A text message will be shown on the instrument cluster display.

If the Blind Spot Monitor has been automatically deactivated, the system cannot be activated until the ignition has been switched off and back on again.

The Blind Spot Monitor is automatically deactivated and cannot be activated when the factory-fitted towing bracket is electrically connected to a trailer or similar ⇒ Trailer towing . Once a trailer is electrically connected to the vehicle and the driver pulls away, a text message appears in the instrument cluster display to inform the driver that the Blind Spot Monitor has been deactivated. The Blind Spot Monitor will be automatically activated again when the trailer has been unhitched from the vehicle. This applies if the function was previously activated. The Blind Spot Monitor must be deactivated manually if you tow a trailer using a towing bracket that was not fitted at the factory.

Troubleshooting



First read and observe the introductory information and safety warnings ⇒  Introduction

 Blind Spot Monitor is not working

The indicator lamp lights up yellow.

Go to a qualified workshop.

System fault

Clean the radar sensors or remove stickers or accessories from the radar sensors, mirrors and bumper ⇒ Caring for and cleaning the vehicle exterior .

Check whether any damage is visible.

The system is not responding as expected

The radar sensors are dirty. The sensor visibility may be impaired by dirt and snow or also residue from cleaning agents or coatings ⇒ Caring for and cleaning the vehicle exterior .

The prerequisites for system operation must be met ⇒ System limits .

The radar sensors are covered by water.

The vehicle is damaged in the area of the radar sensors, e.g. caused by parking collisions.

The detection ranges of the radar sensors are blocked by add-on parts, e.g. bicycle carriers.

Changes have been made to the paintwork in the area of the radar sensors or structural modifications have been made, e.g. on the vehicle front end or the running gear.

Only Volkswagen-approved vehicle paints may be used on the rear bumper. Other vehicle paints can restrict the function of the system or cause faults.

Tinting foils have been retrofitted on the side windows.

Parking and manoeuvring

Parking

Stopping and parking the vehicle

The actions should be carried out only in the given order:

Stop the vehicle on a suitable surface ⇒  .

Depress and hold the brake pedal until the engine has stopped.

Switch on the electronic parking brake ⇒ Electronic parking brake . The electronic parking brake is switched on when the indicator lamp in the button ⇒ Fig. 125 lights up yellow and the indicator lamp  in the instrument cluster display lights up red.

On vehicles with a manual gearbox, either fully depress or disengage the clutch.

With an automatic gearbox, move the selector lever to position P.

Switch off the engine and take your foot off the brake pedal.

Turn the steering wheel slightly if necessary to engage the steering lock mechanism.

With a manual gearbox, select first gear for flat ground and uphill gradients, or reverse gear for downhill gradients, and then release the clutch.

Please ensure that all occupants, in particular children, leave the vehicle.

Take all vehicle keys with you when you leave the vehicle.

Lock the vehicle.

Additional points to note on uphill and downhill gradients

Before switching off the engine, turn the steering wheel so that the front wheels will roll against the kerb if the parked vehicle starts to move.

When facing downhill, turn the wheels so that they face the kerb.

When facing uphill, turn the wheels so that they face the centre of the road.

 WARNING

The components of the exhaust system become very hot. This can cause fires and serious injuries.

Never park the vehicle where parts of the exhaust system can come into contact with inflammable material underneath the vehicle, e.g. undergrowth, leaves, dry grass, spilt fuel, oil etc.

 WARNING

The vehicle may roll away if you leave and park the vehicle incorrectly. This can cause accidents and serious injuries.

Ensure that the electronic parking brake is switched on before you leave the vehicle and the  indicator lamp in the instrument cluster lights up red after you switch off the ignition.

Never remove the vehicle key from the ignition if the vehicle is in motion. The steering lock may be activated and you will no longer be able to steer or control the vehicle.

Never leave children or people requiring assistance alone in the vehicle. They could switch off the electronic parking brake, or move the selector lever or gearshift lever, and thus set the vehicle in motion.

Always take all vehicle keys with you every time you leave the vehicle. The engine can be started and electrical equipment such as the window controls can be operated. This can cause serious injury.

Never leave children or people requiring assistance alone in the vehicle. They could become trapped in the vehicle in an emergency and may not be able to get themselves to safety. For example, locked vehicles may be subjected to very high or very low temperatures depending on the season. This can cause serious injuries and illness or fatalities, especially in the case of small children.

 NOTICE

Objects that protrude from the ground can damage the bumper and other components when parking the vehicle or driving out of a parking space. Always take care when driving into parking spaces with high kerbs or fixed boundaries. Stop before the wheels touch the fixed boundaries or kerbs.

Low-lying vehicle components such as the bumper, spoiler and parts of the running gear, engine or exhaust system could be damaged. Drive carefully through dips in the road and over drive entrances, ramps, kerbstones and other objects.



Please adhere to relevant legislation when stopping and parking your vehicle.

Electronic parking brake

Operating the electronic parking brake

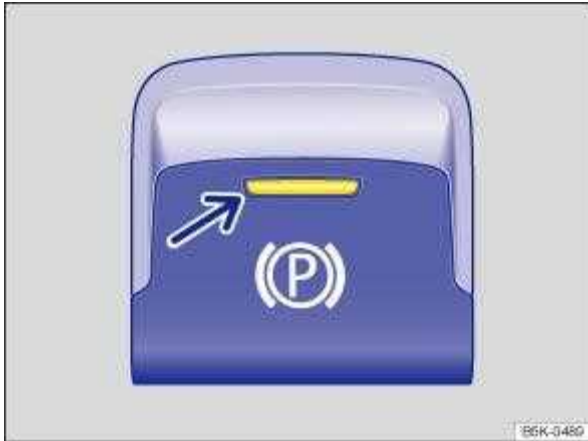

Fig. 125 In centre console: button for the electronic parking brake.

Switching on

When the vehicle is stationary, pull and hold the **(P)** button.

If the indicator lamp in the button \Rightarrow Fig. 125 and the red **(P)** indicator lamp in the instrument cluster light up, the electronic parking brake is switched on.

Release the button.

Switching off

Switch on the ignition.

The indicator lamp in the button \Rightarrow Fig. 125 and the red **(P)** indicator lamp in the instrument cluster display will go out.

Moving off on steep uphill gradients or with increased vehicle weight

You can prevent the electronic parking brake from switching off automatically by pulling the **(P)** button upwards and holding it while pulling away.

If higher engine power is required to move off, the electronic parking brake will be deactivated only when you release the **(P)** button.

This can make it easier to move off with a high trailer weight \Rightarrow Trailer towing .

Emergency braking function

The emergency braking function should be used only in those situations where the vehicle cannot be stopped using the foot brake ⇒ ⚠ !

Pull the  button. The vehicle brakes hard. A signal tone can be heard at the same time.

WARNING

Incorrect use of the electronic parking brake can cause accidents and serious injuries.

Never use the electronic parking brake to brake the vehicle, except in emergencies. The braking distance is considerably longer as only the rear wheels are braked. Always use the foot brake.

WARNING

Failing to park the vehicle properly before leaving it may result in the vehicle rolling away. This can cause accidents, serious injuries and damage to property.

Always park the vehicle in the specified order ⇒ Parking .

Ensure that the electronic parking brake is switched on before you leave the vehicle and the  indicator lamp in the instrument cluster lights up red after you switch off the ignition.

Troubleshooting

Fault in electronic parking brake

The indicator lamp lights up yellow. Go to a qualified workshop or a Volkswagen dealership.

Electronic parking brake does not switch off

The prerequisites for switch off are not met.

OR: the 12-volt vehicle battery is discharged.

Check whether all requirements for switching off the electronic parking brake are met ⇒ Switching off .

Use jump leads ⇒ Jump starting the vehicle .

Noises from the electronic parking brake

You may hear noises when the electronic parking brake is switched on and off.

If the electronic parking brake has not been used for a long period, the system will carry out occasional automatic and audible checks when the vehicle is parked.

Auto Hold function

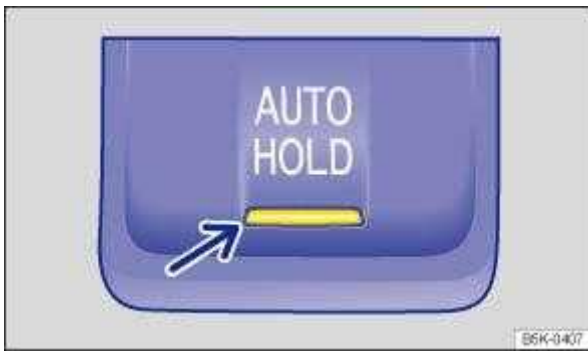

Fig. 126 In the centre console: button for the Auto Hold function.

Description of the Auto Hold function

The Auto Hold function can hold the vehicle stationary. It is not necessary to hold the vehicle with the foot brake in this case.



The Auto Hold function is active when the indicator lamp in the **AUTO HOLD** button ⇒ Fig. 126 (arrow) lights up yellow and the indicator lamp **(P)** in the instrument cluster display lights up green.

The Auto Hold function stops holding the vehicle as soon as it moves off.

If any of the conditions for the Auto Hold function change while the vehicle is stationary, the Auto Hold function will switch off automatically. The green indicator lamp **(P)** in the instrument cluster display then goes out together with the yellow indicator lamp in the **AUTO HOLD** button.

Switching on the Auto Hold function

The Auto Hold function can be switched on when the driver door is closed and the engine has been started.

Press the **AUTO HOLD** button ⇒ . The indicator lamp in the **AUTO HOLD** button ⇒ Fig. 126 (arrow) lights up yellow. The Auto Hold function is operational, but the vehicle is not necessarily held stationary ⇒ .

DSG® dual clutch gearbox: if the selector lever is moved to position N, the Auto Hold function will not be switched on or will be switched off. As a result, the vehicle will not be held securely in a stationary position ⇒ .

Holding the vehicle stationary with the Auto Hold function

Make sure that the Auto Hold function is operational. The indicator lamp in the **AUTO HOLD** button lights up yellow.

Bring the vehicle to a standstill using the brake ⇒ Parking .

Manual gearbox: disengage the clutch and either keep the clutch fully depressed or shift to neutral.

Release the brake. The indicator lamp **(P)** will light up green on the instrument cluster display. The vehicle is being held stationary by the Auto Hold function ⇒ .

Switching off the Auto Hold function

Press the **AUTO HOLD** button ⇒ . The indicator lamp in the **AUTO HOLD** button ⇒ Fig. 126 (arrow) goes out.

The electronic parking brake switches on automatically to hold the vehicle securely. However, the electronic parking brake will not switch on if the brake pedal is depressed when the Auto Hold function is switched off ⇒ .

Temporarily switching off the Auto Hold function with the  button



It can sometimes be necessary to switch off the Auto Hold function temporarily to enable the vehicle to roll more easily, for example when manoeuvring.

Press the brake pedal when the engine is on.

Press the  button. The Auto Hold function is deactivated.

The Auto Hold function will be reactivated as soon as the brake pedal is depressed again when the vehicle has come to a standstill.

System limits

If the clutch slips during switching off of the ignition or opening of the driver door, the vehicle may not be secured against rolling away by either the Auto Hold function or the electronic parking brake ⇒ . After switching off the ignition or opening the driver door, make sure that the indicator lamp  in the instrument cluster displaylights upred. The electronic parking brake is switched on.

WARNING

The intelligent Auto Hold function cannot overcome the laws of physics, and operates only within the limits of the system. Do not let the extra convenience afforded by the Auto Hold function tempt you into taking any safety risks when driving.

Make sure that the indicator lamp  lights up green or red on the instrument cluster display if the vehicle is to be held securely. The vehicle is being held by the Auto Hold function if the green indicator lamp is lit and by the electronic parking brake if the red warning lamp is lit.

Never leave the vehicle if the engine is running and the Auto Hold function is switched on.

In some cases, the Auto Hold function cannot sufficiently hold the vehicle on uphill gradients or brake it sufficiently on downhill gradients, e.g. if the ground is slippery or icy.

NOTICE

Switch off the Auto Hold function before driving into a car wash. Damage may otherwise be caused by automatic activation of the electronic parking brake.

Safety notes on the parking systems

The parking systems include the following:

Park Distance Control ⇒ Park Distance Control .

Rear view camera system (Rear View) ⇒ Rear view camera system (Rear View) .

Park Assist ⇒ Park Assist .

The available systems vary according to the vehicle equipment level.

Limits of the parking systems

The sensors or cameras may not always be able to detect objects such as thin rails, fences, posts, trees, very low or high obstacles and open or opening boot lids.

In some cases, dirt and ice on the sensors or cameras could be registered as an obstacle.

Limits of the rear view camera system

The rear view camera system shows only two-dimensional images on the screen. The lack of depth of field means that potholes and protruding objects on the ground may only be detected with difficulty, or may not be detected at all.

The system displays the orientation lines irrespective of the area surrounding the vehicle. There is no automatic obstacle detection. Drivers must judge for themselves whether the vehicle will fit into the parking space.



The intelligent technology used in the parking systems cannot overcome the laws of physics, and functions only within the limits of the system. Never let the extra convenience afforded by the parking systems tempt you into taking any risks when driving. The parking systems cannot replace the full concentration of the driver.

Always adapt your speed and driving style to suit visibility, weather, road and traffic conditions.

Unintentional vehicle movements can cause serious injury.

Keep looking in the direction in which you are parking and at the relevant area surrounding the vehicle.

Do not allow the displays in the instrument cluster and the images shown in the Infotainment system to distract you from the traffic.

Always monitor the area around the vehicle as the parking systems will not always detect infants, animals and objects.

The parking systems have blind spots in which obstacles and people are not registered.

External sources of sound and certain surfaces on objects and clothing may influence the signals of the sensors. In certain circumstances, the systems will be unable to detect or properly detect people and objects.

Certain objects, for example narrow posts or railings, may be difficult or impossible to see on the screen because of its resolution or poor light conditions.

When approaching objects at high speeds, the signals and displays of the parking systems may not respond quickly enough to issue a warning.



Volkswagen recommends that drivers practise using the parking systems in a traffic-calmed area or car park to allow them to familiarise themselves with the systems and their functions.

Park Distance Control



Introduction

This chapter contains information on the following subjects:

⇒ Switching on and off

⇒ Display representation

⇒ Troubleshooting

The Park Distance Control system assists the driver when manoeuvring and parking.

Park Distance Control detects the distance from an obstacle by means of sensors in the front and rear areas of the vehicle. If there is an obstacle in the detection range of the sensors, the system indicates this on the Infotainment system and by means of signal tones.

Settings

With some equipment levels, settings for Park Distance Control can be made in the Infotainment system ⇒ Infotainment system controls and displays .

You can save some settings in the user accounts of the personalisation function. The settings change automatically when the user account is changed ⇒ Personalisation .

Switching on and off



Fig. 127 In the centre console: button for switching Park Distance Control on and off (depending on equipment).



First read and observe the introductory information and safety warnings ⇒ Introduction

Switching on Park Distance Control

Press the  button.

Park Distance Control is switched on automatically when reverse gear is engaged or if the vehicle rolls backwards.

With some equipment levels, Park Distance Control can also be activated automatically when driving forwards ⇒ Automatic activation when driving forwards (with some equipment levels) .

Switching off Park Distance Control

Press the  button.

Park Distance Control is switched off automatically when the vehicle is driven forwards at a speed of more than 10–15 km/h (6–9 mph).

OR: the selector lever is moved to P position.

Automatic activation when driving forwards (with some equipment levels)

Park Distance Control also switches itself on automatically if the vehicle approaches an obstacle in the front area of the vehicle when driving forwards at a speed of less than 15 km/h (9 mph).

Automatic activation can be switched on in the Infotainment system.

Automatic activation takes place only once. Renewed automatic activation is possible under the following conditions:

Press the  button.

Switch the ignition off and then back on again.

Manoeuvre braking

If the vehicle is equipped with manoeuvre braking, the manoeuvre braking function triggers emergency braking as soon as an obstacle is detected while reversing.

Depending on the vehicle equipment, the manoeuvre braking function can also trigger emergency braking when driving forwards.

The manoeuvre braking function helps to prevent collisions. The vehicle speed must not be higher than 10 km/h (6 mph). The manoeuvre braking function is activated or deactivated when Park Distance Control is switched on or off. The manoeuvre braking function is inactive for five metres after a braking operation in the same direction of travel. The manoeuvre braking function is ready for braking again after changing gear or position. The same restrictions apply as to Park Distance Control.

Manoeuvre braking is not active if Park Distance Control was activated automatically.

Touch the  function button in the Infotainment system to switch manoeuvre braking on and off.

Display representation

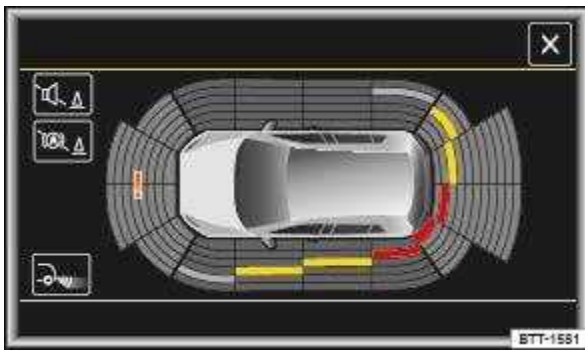

Fig. 128 Display in the Infotainment system: full-screen mode. The scanned areas depend on the vehicle equipment level.

First read and observe the introductory information and safety warnings ⇒ Introduction

When the vehicle approaches an obstacle, this is shown in the Infotainment system in several segments and is supported by an acoustic signal ⇒ Fig. 128 . This display along the side of the vehicle can vary depending on the situation.

Obstacle close to the vehicle. A continuous tone sounds. Do not drive on! Obstacle in the vehicle path. An intermittent tone sounds. The shorter the distance, the shorter the intervals. Obstacle outside the vehicle path. Mute signal tones. Switch manoeuvre braking on and off (depending on vehicle equipment). Switch to rear view camera system (depending on vehicle equipment). System fault in the scanned area (depending on equipment level). The colour may vary.

Troubleshooting

First read and observe the introductory information and safety warnings ⇒ Introduction

The system is not responding as expected

The sensors are dirty ⇒ Caring for and cleaning the vehicle exterior . The sensor visibility may be impaired by dirt and snow or also residue from cleaning agents or coatings.

The prerequisites for system operation are not met ⇒ Automatic activation when driving forwards (with some equipment levels) .

The factory-fitted towing bracket is electrically connected with the trailer ⇒ Notes on towing a trailer .

Only the scanned area to the front of the vehicle is shown on the Infotainment system display in vehicles with a factory-fitted towing bracket and a trailer with an electrical connection to the vehicle ⇒ Notes on towing a trailer .

The vehicle is damaged in the area of the sensors, e.g. caused by parking collisions.

The detection ranges of the sensors are blocked by add-on parts, e.g. bicycle carriers.

Changes have been made to the paintwork in the area of the sensors or structural modifications have been made, e.g. on the running gear.

The ultrasound signal is subject to interference from external noise sources, e.g. rough tarmac surface or cobblestones.

No sensor visibility, error message, system switches itself off

The sensor area is switched off permanently if a sensor fails.

Park Distance Control malfunctions will be indicated by a text message with an acoustic warning and the indicator lamp in the **P** button flashing when the system is switched on for the first time. If the sensors are dirty or covered, the affected sensor cluster will be displayed on the Park Distance Control screen. A cleaning message also appears (depending on the vehicle equipment level).

Possible solution

Switch off the system temporarily.

Check whether any of the causes described apply.

Clean the sensors or remove stickers or accessories from the sensors and cameras ⇒ Caring for and cleaning the vehicle exterior .

Check whether any damage is visible.

You can switch the system back on again once you have rectified the cause of the problem.

If the system still fails to respond as expected, have the system checked by a qualified workshop or your Volkswagen dealership.

Rear view camera system (Rear View)



Introduction

This chapter contains information on the following subjects:

⇒ Switching on and off

⇒ Display representation

⇒ Prerequisites

⇒ Parking

⇒ Troubleshooting

The rear view camera system in the rear of the vehicle makes it easier for the driver to see behind the vehicle and provides support for parking manoeuvres.

The rear view camera system shows the area behind the vehicle on the Infotainment system screen. Depending on the operating mode, orientation lines support the view to the rear.



WARNING

Using images from the camera to estimate the distance from obstacles (people, vehicles etc.) is inaccurate and could cause accidents and severe injuries.

Camera lenses enlarge and distort the field of vision and show objects differently and inaccurately on the screen.

Switching on and off



First read and observe the introductory information and safety warnings ⇒ Introduction

Switching on the rear view camera system

Select reverse gear.

OR: press the button.

Switching off the rear view camera system

Drive forwards at a speed of at least 10 km/h (6 mph).

Display representation



First read and observe the introductory information and safety warnings ⇒ Introduction

The functions and displays of the rear view camera system image vary according to the equipment level and may differ from each other.

The display of the reversing camera picture varies if the factory-fitted towing bracket is electrically connected to the trailer ⇒ Notes on towing a trailer .

Functions and symbols of the rear view camera system

You can make settings by means of the function buttons when the rear view camera system is switched on. Some setting options depend on the vehicle equipment.

x Close current display. * Adjust display: brightness, contrast, colour. Switch to Park Distance Control ⇒ Park Distance Control. Show Park Distance Control display. Hide Park Distance Control display.

Orientation lines

Red line: safety distance to the rear.

Green lateral lines: extension of the vehicle.

Prerequisites



First read and observe the introductory information and safety warnings ⇒ Introduction

The prerequisites for parking using the rear view camera system must be met.

Do not exceed a speed of approximately 15 km/h (9 mph).

Width of the parking space: vehicle width + 0.2 m.

The following conditions must be met in order to display a correct image:

The boot lid is closed.

The surrounding area has a flat surface.

Vehicle does not have a heavy load at the rear.

Parking

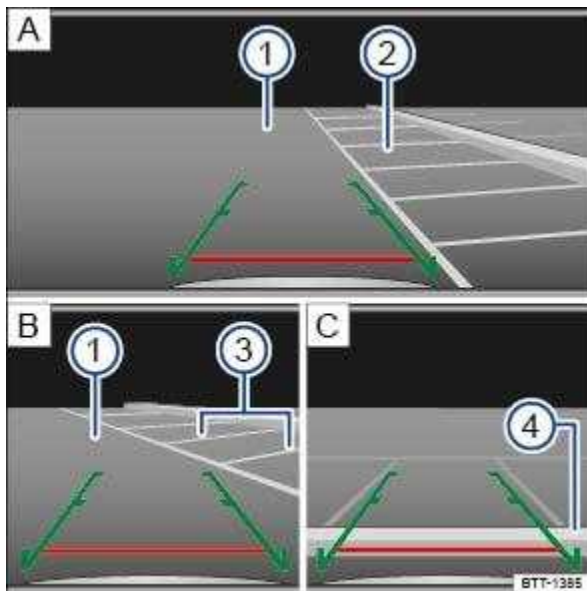

Fig. 129 Infotainment system display: parking using the rear view camera system.

First read and observe the introductory information and safety warnings ⇒ Introduction

Key to ⇒ Fig. 129 :

A Choose parking space. **B** Drive towards the selected parking space. **C** Align the vehicle in the parking space. 1 Road. 2 Selected parking space. 3 Side limits of the selected parking space. 4 Rear limit of the parking space.

Parking using the rear view camera system

Position the vehicle in front of the parking space ⇒ Fig. 129 ② **A**.

Select reverse gear.

Reverse slowly and steer the vehicle so that the lateral lines lead into the selected parking space. The lines must correspond to the lateral boundary lines of the parking space ③ **B**.

Stop when the horizontal line reaches the rear boundary ④ **C**.

Troubleshooting

First read and observe the introductory information and safety warnings ⇒ Introduction

The system is not responding as expected

The camera is dirty ⇒ Caring for and cleaning the vehicle exterior . The camera visibility may be impaired by dirt and snow or even residue from cleaning agents or coatings.

The system requirements must be met ⇒ Prerequisites .

The factory-fitted towing bracket is electrically connected with the trailer ⇒ Notes on towing a trailer .

The vehicle is damaged in the area around the camera, e.g. caused by parking collisions.

The detection range of the camera is blocked by add-on parts, e.g. bicycle carriers.

Changes have been made to the paintwork in the area of the camera or structural modifications have been made, e.g. on the running gear.

No camera visibility, error message, system switches itself off

Clean the camera or remove stickers or accessories from the camera ⇒ Caring for and cleaning the vehicle exterior .

Check whether any damage is visible.

Possible solution

Switch off the system temporarily.

Check whether any of the causes described apply.

You can switch the system back on again once you have rectified the cause of the problem.

If the system still fails to respond as expected, have the system checked by a qualified workshop.

Park Assist



Introduction

This chapter contains information on the following subjects:

⇒ Prerequisites

⇒ Looking for a parking space

⇒ Driving into a parking space

⇒ Driving out of a parking space

⇒ Troubleshooting

Park Assist shows parking spaces which are suitable for parking and assists the driver when driving into and out of parking spaces.

Park Assist is an extension of Park Distance Control ⇒ Park Distance Control .

Park Assist automatically steers the vehicle. The driver must control the accelerator, gear changes and brake ⇒ Safety notes on the parking systems .



WARNING

Fast steering wheel movements can cause serious injury.

During the manoeuvring operation, do not reach for the steering wheel until prompted to do so by the system.

Exception: if a dangerous situation occurs, intervene and take over the steering.

NOTICE

Park Assist uses parked vehicles, the kerbs and other objects as guidance. Make sure that the tyres and wheel rims are not damaged when parking the vehicle. If necessary, stop the parking procedure in good time to prevent damage to the vehicle.

Prerequisites



First read and observe the introductory information and safety warnings ⇒  Introduction

The following prerequisites must be met for driving into and out of parking spaces:

The traction control system (TCS) must be switched on ⇒ Brake support systems .

Distance: maintain a distance of 0.5 – 2.0 metres when driving past the parking space.

The parking space must have at least the dimensions required by Park Assist.

Speed when driving past the parking space (for parking spaces parallel to the road): not above 40 km/h (25 mph).

Speed when driving past the parking space (for parking spaces perpendicular to the road): not above 20 km/h (12 mph).

Maximum speed: 7 km/h (4 mph). An automatic braking intervention can take place when driving into a parking space.

No trailer is connected electrically with the factory-fitted towing bracket ⇒ Notes on towing a trailer .

The parking manoeuvre can be continued after the automatic brake intervention.

The automatic braking intervention takes place a maximum of once per parking manoeuvre. The parking manoeuvre will be cancelled if a speed of approximately 7 km/h (4 mph) is exceeded again.



WARNING

Do not let the automatic braking intervention triggered by Park Assist tempt you to take any risks while driving. The system is not a substitute for the full concentration of the driver.

Park Assist has system-related limitations. In some situations, automatic braking intervention may function only in a limited way or not at all.

You should always be prepared to brake the vehicle yourself.

The automatic braking intervention is ended after approximately 1.5 seconds. Depress the brake pedal of the vehicle yourself following the automatic braking intervention.

Looking for a parking space

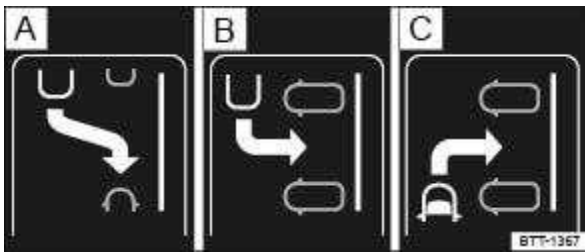

Fig. 130 On the instrument cluster display: display of parking modes.

First read and observe the introductory information and safety warnings ⇒ Introduction

Park Assist has three parking modes ⇒ Fig. 130 (illustration).

A Reverse parallel parking. **B** Reverse perpendicular parking. **C** Forward perpendicular parking.

Drive slowly past a row of parked vehicles, paying attention to the traffic.

Press the **P** button. Park Assist automatically searches for a suitable parking space on the front passenger side.

Stop when Park Assist displays a recommended parking mode on the instrument cluster display.

Drive into the parking space when a corresponding prompt ⇒ Fig. 131 is shown on the instrument cluster display ⇒ Driving into a parking space .

If you want Park Assist to search for a parking space on the opposite side of the road, operate the turn signal for the corresponding side.

Changing parking mode

If Park Assist has found other alternative parking modes, these will be displayed in a miniature view.

They can be selected in turn by repeatedly pressing the **P** button. Park Assist will switch itself off after selection of all found parking modes. The originally recommended parking mode is offered when the **P** button is pressed again.

If you wish to park in a perpendicular parking space in forward direction, select Forward perpendicular parking ⇒ Fig. 130 **C**. Otherwise the vehicle will reverse into the perpendicular parking space.



Park Assist can be activated retrospectively. If the vehicle has previously driven past a suitable parking space, it will be displayed.

Driving into a parking space

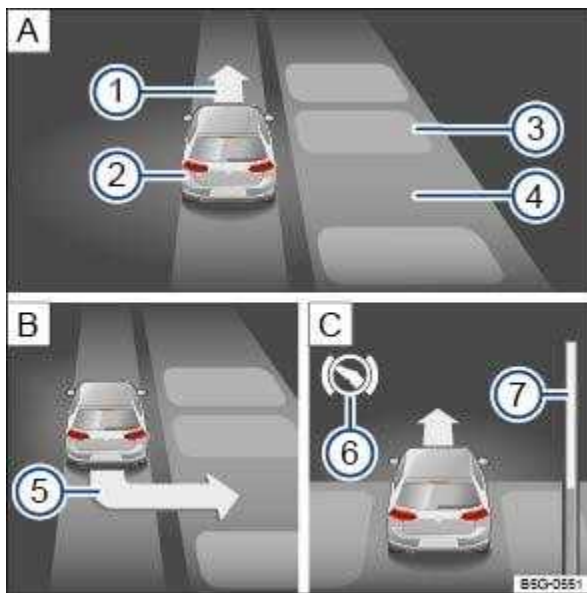

Fig. 131 On the instrument cluster display: parking perpendicular to the road.

First read and observe the introductory information and safety warnings ⇒ Introduction

Key to ⇒ Fig. 131 :

A Choose parking space. **B** Position for parking. **C** Align the vehicle in the parking space. 1 Prompt to drive forward. 2 Your vehicle. 3 Parked vehicle or obstacle. 4 Detected parking space. 5 Prompt to select reverse gear. 6 Prompt to press the brake pedal. 7 Progress bar. Symbolically shows the relative distance still to be driven.

The prerequisites for parking space selection must be met ⇒ Prerequisites and the vehicle must be stationary.

Let go of the steering wheel ⇒ .

Select reverse gear when a reverse arrow appears on the instrument cluster display.

Accelerate carefully.

Brake when an acoustic signal sounds to indicate that you should change direction, an arrow ⇒ Fig. 131 **1** **A** lights up, the display lights up or a message is shown.

Drive forwards until an acoustic signal sounds or until the prompt to reverse is shown on the instrument cluster display.

Repeat reversing and driving forwards until a corresponding message is displayed on the instrument cluster. A signal tone may also sound.

Driving out of a parking space

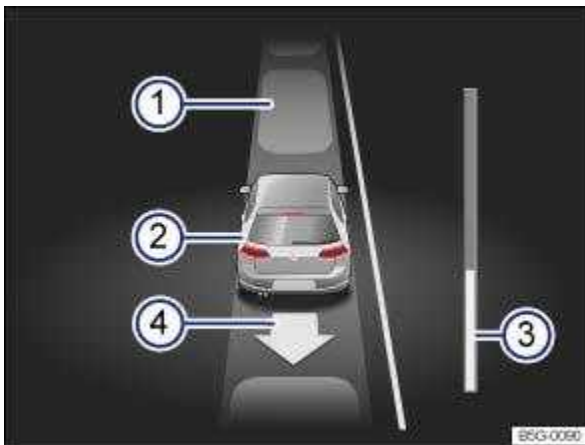

Fig. 132 On the instrument cluster display: driving out of a parallel parking space.



First read and observe the introductory information and safety warnings ⇒ Introduction

Key to ⇒ Fig. 132 :

- ① Parked vehicle.
- ② Own vehicle with reverse gear engaged.
- ③ Progress bar. Symbolically shows the relative distance still to be driven.
- ④ Direction indicator for next manoeuvre for driving out of the parking space.

Park Assist can drive out of parallel parking spaces if the prerequisites for this are met
⇒ Prerequisites .

Press the **P** button.

Use the turn signal lever to select the direction (left or right) in which you would like to drive out of the parking space.

Select reverse gear.

Release the steering wheel when the following message is shown: Steer. intervention active.
Monitor vehicle area.

Accelerate carefully.

Brake when an acoustic signal sounds, the display  lights up or until the prompt to drive forward appears on the instrument cluster display.

Depress the brake pedal until Park Assist has finished steering or until the display  in the instrument cluster display will go out.

Repeat reversing and driving forwards until a corresponding message is displayed on the instrument cluster. A signal tone may also sound.

Take over steering with the steering angle set by Park Assist.

Drive the vehicle out of the parking space when permitted by the traffic situation.

Troubleshooting



First read and observe the introductory information and safety warnings ⇒  Introduction

The system is not responding as expected

The sensors are dirty ⇒ Caring for and cleaning the vehicle exterior . The sensor visibility may be impaired by dirt and snow or also residue from cleaning agents or coatings.

The system requirements must be met ⇒ Prerequisites .

The sensors are covered by water.

The vehicle is damaged in the area of the sensors, e.g. caused by parking collisions.

The detection ranges of the sensors are blocked by add-on parts, e.g. bicycle carriers.

Changes have been made to the paintwork in the area of the sensors or structural modifications have been made, e.g. on the vehicle front end or the running gear.

The ultrasound signal is subject to interference from external noise sources, e.g. rough tarmac surface or cobblestones.

No sensor visibility, error message, system switches itself off

Park Assist is switched off if a sensor fails.

Clean the sensors or remove stickers or accessories from the sensors and cameras ⇒ Caring for and cleaning the vehicle exterior .

Check whether any damage is visible.

Possible solution

Switch off the system temporarily.

Check whether any of the causes described apply.

You can switch the system back on again once you have rectified the cause of the problem.

If the system still fails to respond as expected, have the system checked by a qualified workshop.

Automatic cancellation of driving in/out of a parking space

Park Assist cancels parking or driving out of a parking space in the following situations:

The  button is pressed.

The driver intervenes using the steering wheel.

The driver door is opened.

The parking operation is not completed within around six minutes.

There is a system fault.

TCS is switched off or is taking corrective action.

Automatic braking intervention to minimise damage

In some countries, Park Assist can assist the driver with an automatic braking intervention in certain situations ⇒ ⚠ .

Depending on the vehicle equipment and certain conditions, e.g. weather, load or inclination of the vehicle, Park Assist can automatically brake the vehicle before an obstacle. Following this intervention, the driver must depress the brake pedal.

The parking manoeuvre is ended if an automatic braking intervention occurs.

Rear Traffic Alert

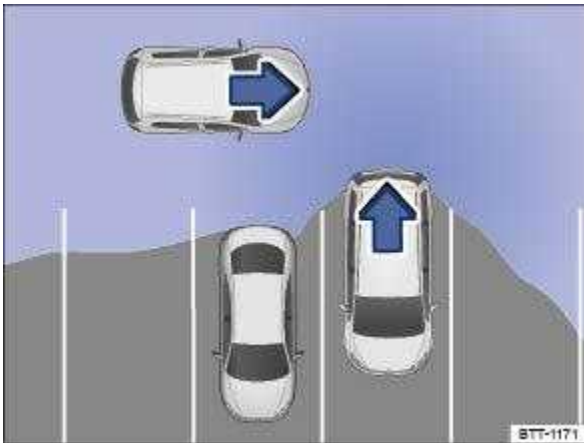

Fig. 133 Illustration of Rear Traffic Alert: monitored area around the vehicle leaving the parking space.

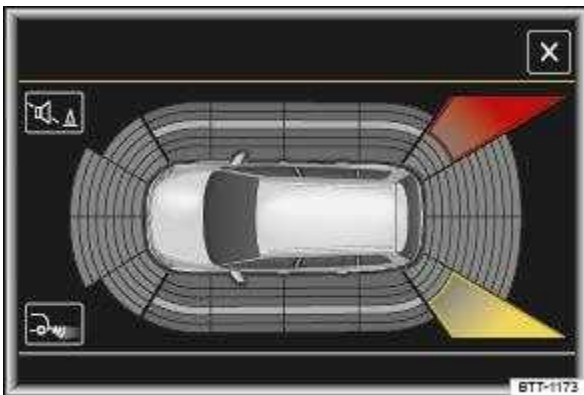

Fig. 134 Display in the Infotainment system: Rear Traffic Alert.

Rear Traffic Alert is part of the Blind Spot Monitor ⇒ Driving with the Blind Spot Monitor .

Switching on and off

By means of the Assist systems menu in the instrument cluster ⇒ Vehicle settings menu .



OR: with some equipment levels, by means of the button for the driver assist systems ⇒ Button for driver assist systems .

OR: with some equipment levels, in the Driver assistance menu in the Infotainment system ⇒ Infotainment system controls and displays .

Function

Rear Traffic Alert monitors the traffic crossing behind the vehicle when reversing out of a parking space or manoeuvring. Rear Traffic Alert functions using radar sensors in the rear bumper.

Key to ⇒ Fig. 134 :

 Critical situation. Do not drive on!  Possible critical situation.

Detection of a critical situation can also take place acoustically:

A warning signal will sound and a text message will be displayed in the instrument cluster for vehicles without Park Distance Control.

In vehicles with Park Distance Control, an acoustic signal will sound with the continuous tone of Park Distance Control. If the Park Distance Control is deactivated, no warning can be given to the driver and the Rear Traffic Alert system will also be switched off temporarily.

If there is a system fault in the scanned area, the  indicator lamp will light up yellow on the instrument cluster display.

Automatic braking intervention to minimise damage

If Rear Traffic Alert detects an approaching road user and the driver has not pressed the brake, the system can brake automatically.

Automatic braking intervention is activated when reversing at speeds of between 1–12 km/h (1–7 mph). The vehicle is held stationary for up to two seconds after vehicle standstill has been detected.

After automatic braking intervention is activated to prevent damage to the vehicle, the system requires approximately ten seconds before it can activate another automatic braking intervention.

Automatic braking intervention can be interrupted by pressing the accelerator or brake pedal sharply and taking control of the vehicle.

Automatic deactivation

Rear Traffic Alert is deactivated automatically and cannot be switched on if the factory-fitted towing bracket is electrically connected to a trailer or similar ⇒ Notes on towing a trailer . Once a trailer is electrically connected to the vehicle and the driver pulls away, a text message appears in the instrument cluster display to inform the driver that Rear Traffic Alert has been deactivated. Rear Traffic Alert will be automatically activated again when the trailer has been unhitched from the vehicle. This applies if the functions were previously activated. Rear Traffic Alert must be switched off manually for trailer towing if a non-factory-fitted towing bracket is used.

WARNING

The intelligent Rear Traffic Alert technology cannot overcome the laws of physics, and functions only within the limits of the system. Do not let the assistance function of Rear Traffic Alert tempt you to take any safety risks while driving. The system is not a substitute for the full concentration of the driver.

Never use the system where visibility is restricted or in unclear traffic situations, e.g. on extremely busy roads or across several lanes.

Always pay attention to the area around the vehicle, since cyclists and pedestrians are often not reliably detected, for example.

The Rear Traffic Alert will not always independently bring the vehicle to a complete stop.

Brake support systems

Information on brake support systems

The vehicle is fitted with brake support systems. The systems can support the driver in critical driving or braking situations. Brake support systems cannot overcome the limits of physics and cannot always keep the vehicle under control in every single critical driving or braking situation. The driver is responsible for driving safety ⇒  .

Driving with brake support systems

The brake support systems work when the engine is running. They do not need to be operated separately.

The brake pedal may pulsate or noises may occur while the brake support systems are regulating. Continue to apply the necessary amount of brake pressure. Apply the necessary pressure to the brake pedal consistently. If necessary, steer the vehicle while the brake pedal is depressed.

Electronic Stability Control (ESC)

ESC helps to reduce the risk of skidding and to improve driving stability in certain driving situations ⇒  .

ESC is always switched on.

Traction control system (TCS)

The TCS reduces the drive output if wheelspin occurs and adapts the drive output to suit road surface conditions ⇒ Troubleshooting . The TCS makes it easier to pull away, accelerate and drive up hills.

With some equipment levels, the TCS can be switched off in exceptional circumstances ⇒ Switching the TCS on and off .

Anti-lock brake system (ABS)

The anti-lock brake system can prevent the wheels from locking when the brakes are applied up until the point where the vehicle is nearly stationary and assists the driver in steering the vehicle and keeping it under control ⇒ Troubleshooting .

Brake assist system

The brake assist system can help to reduce the stopping distance. The brake assist system reinforces the braking force when the driver depresses the brake pedal quickly in an emergency situation.

If you reduce the pressure on the brake pedal, the brake assist system will switch off the brake servo.

Electronic differential lock (EDL and XDS)

EDL brakes a spinning wheel automatically and distributes the drive force to the other drive wheels.

The EDL switches off automatically under unusually heavy loads to prevent the brake from overheating. The EDL switches back on again automatically as soon as the brake has cooled down.

XDS improves traction in order to keep the vehicle on its intended course.

Automatic Post-Collision Braking System

In the event of a collision, the Automatic Post-Collision Braking System can help the driver to reduce the risk of skidding, and the danger of secondary collisions, through automatic braking.

The Automatic Post-Collision Braking System functions only for collisions that are detected as a collision by the airbag control unit.

The vehicle is braked automatically if the required systems have not been damaged in the collision and have remained functional.

The following actions override automatic braking in the event of a collision:

When the driver depresses the accelerator.

When the brake pressure transmitted through the depressed brake pedal is greater than the brake pressure provided by the system.

WARNING

The intelligent technology used in brake support systems cannot overcome the laws of physics, and functions only within the limits of the systems. Driving fast on icy, slippery or wet roads can lead to a loss of control of the vehicle and could cause serious injury to the driver and passengers.

Always adapt your speed and driving style to suit visibility, weather, road and traffic conditions. Do not let the extra safety afforded by the brake support systems ABS, BAS, EDL, TCS and ESC tempt you into taking any risks when driving.

The brake support systems cannot overcome the laws of physics. Slippery and wet roads will remain dangerous, even when the ESC and other systems are active.

Driving too fast on wet roads can cause the wheels to lose contact with the road surface and aquaplane. The vehicle cannot be braked, steered or controlled once it has lost contact with the road surface.

Brake support systems cannot prevent an accident if, for example, you are driving too close to the vehicle in front or are driving too fast for the individual situation.

Although the brake support systems are very effective and can help to control the vehicle in difficult driving situations, please always remember that the driving stability of the vehicle depends on the tyre grip.

When accelerating on a slippery surface, for example on ice and snow, accelerate carefully. The wheels can spin even when brake support systems are active, and this can lead to a loss of control of the vehicle.

 **WARNING**

The effectiveness of ESC can be reduced considerably if other components and systems which affect driving dynamics are not serviced properly or are not functioning properly. This also applies, but not exclusively, to the brakes, tyres and other named systems.

Please always bear in mind that modifications and changes to the vehicle can affect the way brake support systems operate.

Alterations to the suspension or the use of non-approved wheel and tyre combinations can affect the function of brake support systems and reduce their effectiveness.

Suitable tyres support the effectiveness of ESC.

 **WARNING**

Driving without the brake servo can considerably increase the braking distance and thus cause accidents and serious injuries.

Never switch the engine or ignition off while the vehicle is in motion.

If the brake servo does not function or the vehicle is being towed, the brake pedal will have to be depressed more forcefully as the braking distance will be increased due to the lack of assistance for the brake system.

Switching the TCS on and off

Switch off the traction control system (TCS) if the vehicle does not have sufficient traction:

When driving in deep snow or on loose surfaces.

When rocking the vehicle free if it is stuck.

Then switch on TCS again.

Switching TCS on and off

TCS can be switched off and on in the Infotainment system ⇒ Infotainment system controls and displays .

When the TCS is switched off, the yellow indicator lamp  lights up on the instrument cluster display.

As soon as the TCS starts regulating, the  indicator lamp flashes yellow.

Troubleshooting

 Do not drive on! Brake system fault.

Warning lamp lights up red.

Seek expert assistance immediately.

 ABS failure or fault.

Warning lamp lights up yellow.

Go to a qualified workshop. The vehicle can be braked without the anti-lock brake system.

 TCS regulating to prevent the wheels from spinning.

Indicator lamp flashes yellow.

 ESC switched off for system-related reasons.

Indicator lamp lights up yellow.

Switch the ignition on and off.

Drive a short distance at a speed of 15 – 20 km/h (9 – 12 mph) if necessary.

If  is still lit up, seek expert assistance.

The brake support systems make noises



Noises may be heard when the brake support systems are performing control interventions.

Unexpected reduction in engine power

Faults can occur in the ESC and TCS systems if the four wheels have different types of tyres.

Any differences in the rolling radius of the tyres can cause the system to reduce engine power unexpectedly.

WARNING

If the brake system warning lamp  lights up together with the ABS indicator lamp , the ABS control function may have failed. This can cause the rear wheels to lock quickly when you brake. Locked rear wheels can lead to a loss of control of the vehicle. If possible, reduce your speed and drive carefully at low speed to the nearest qualified workshop in order to have the brake system tested. Avoid sudden braking and driving manoeuvres on the way.

If the ABS indicator lamp  does not go out or comes on while the vehicle is in motion, ABS is not working properly. The vehicle can be stopped using the normal brakes only (without the anti-lock brake system). The protection provided by the anti-lock brake system is no longer available. Go to a qualified workshop as soon as possible.

Practical equipment

Stowage areas



Introduction

This chapter contains information on the following subjects:

⇒ Stowage compartment on the front passenger side

⇒ Stowage compartment in the front centre armrest

⇒ Drawers

⇒ Coat and bag hooks

Stow only light and small objects in the stowage areas.

There is a stowage compartment for the vehicle wallet under the left front seat. Always keep the vehicle wallet in this stowage compartment.

The USB socket and the function for wireless charging in accordance with the Qi standard ⇒ Booklet Infotainment system, may be located in the stowage compartment in the lower part of the centre console.



WARNING

Loose objects may be flung through the vehicle interior in the event of a sudden driving or braking manoeuvre. This can cause serious injury and can also lead to loss of control of the vehicle.

Do not stow any pets or any hard, heavy or sharp objects in the vehicle's open stowage compartments, on the dash panel, on the luggage compartment cover or in items of clothing and bags in the vehicle interior.

Always keep stowage compartments closed while the vehicle is in motion.



WARNING

Objects in the driver footwell can interfere with pedal operation. This can lead to loss of control of the vehicle and increase the risk of serious injury.

Ensure that all pedals can always be operated without any hindrance.

The floor mats must always be properly secured in the footwell.

No additional foot mats or other floor coverings should be placed over the fitted foot mat.

Ensure that no objects can enter the driver footwell while the vehicle is in motion.



WARNING

Cigarette lighters left in the vehicle can become damaged or may ignite unnoticed. This can cause serious burns and vehicle damage.

Before adjusting the seats, always ensure that there is no cigarette lighter on or near the moveable parts of the seat.

Before closing stowage areas or compartments always ensure that there is no lighter in the way.

Never stow lighters in stowage areas or compartments or on other surfaces in the vehicle. Cigarette lighters may self-ignite as a result of high surface temperatures, particularly in summer.

! NOTICE

The heating elements in the rear window can be destroyed by objects rubbing against them.

Do not stow any temperature-sensitive objects, food or medicines inside the vehicle. Hot and cold temperatures could damage them or render them unusable.

Objects stored in the vehicle that are made from transparent materials, such as glasses, magnifying glasses or transparent suction cups on the windows, can concentrate the sun's rays and thus cause damage to the vehicle.



Always ensure that the ventilation openings between the rear window and the stowage area are uncovered to allow stale air to escape from the vehicle.

Stowage compartment on the front passenger side

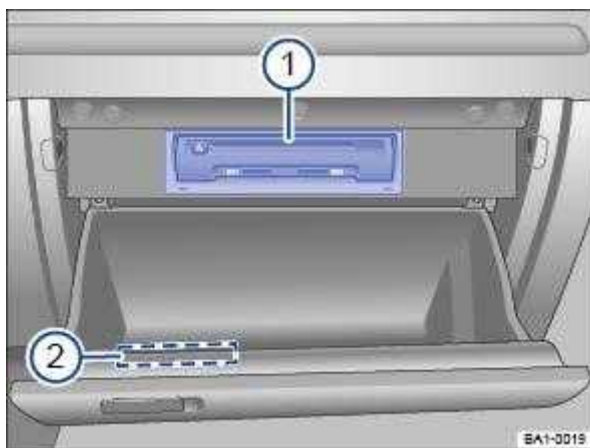

Fig. 135 On the front passenger side: open stowage compartment.



First read and observe the introductory information and safety warnings ⇒ Introduction

Key to ⇒ Fig. 135 :

① Media drives for the Infotainment system, card readers ⇒ Booklet Infotainment system,.

② Mounting for glasses compartment.

Opening and closing the stowage compartment

If necessary, unlock the stowage compartment. The stowage compartment is locked when the key slot is vertical.

To open: pull the opening lever.

To close: push the stowage compartment upwards.

 **WARNING**

If the stowage compartment on the front passenger side is left open, this can increase the risk of serious injury in the event of an accident or during sudden braking or driving manoeuvres.

Always keep the stowage compartment closed while the vehicle is in motion.

 **NOTICE**

In some vehicle models, the stowage compartment on the front passenger side contains apertures. Small items could fall through the apertures and become trapped behind the trim. This could cause unusual noises and damage to the vehicle.

Stow small objects only in the stowage areas that are intended for such items.

Stowage compartment in the front centre armrest



Fig. 136 In the front centre armrest: stowage compartment.

 First read and observe the introductory information and safety warnings ⇒  Introduction

To open: lift the centre armrest ⇒ Fig. 136 .

To close: guide the centre armrest down.

 **WARNING**

The centre armrest can obstruct the driver's arm movements. This can cause accidents and severe injuries.

Always keep the stowage compartments in the centre armrest closed while the vehicle is in motion.

 **WARNING**

Never transport an adult or child on the centre armrest.



There may be a mobile phone interface, a mobile phone holder and a USB socket  with charging function in the stowage compartment ⇒BookletInfotainment system,.

Drawers

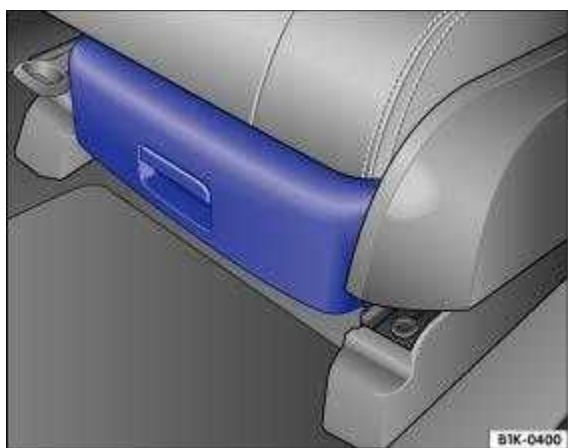



Fig. 137 Under the right front seat: drawer.



First read and observe the introductory information and safety warnings⇒  Introduction

To open: press the button in the drawer grip and open the drawer.

To close: push the drawer under the front seat until it clicks into place.

 **WARNING**

If the drawer is left open, it can hinder the correct operation of the pedals. This can result in accidents and severe injuries.

Always keep the drawers closed while the vehicle is in motion. Otherwise the drawer or other items could fall into the driver footwell and obstruct the pedals.

 **NOTICE**

The drawer is designed for a maximum load of 1.5 kg.

Coat and bag hooks



First read and observe the introductory information and safety warnings⇒  Introduction

Coat hooks are located on the centre door pillars and on the rear roof grab handles.

Bag hooks are located in the luggage compartment ⇒ Luggage compartment equipment .

 WARNING

Hanging up items of clothing can restrict the driver's field of vision and cause accidents and serious injuries.

Always hang items of clothing on the coat hook in such a way that they do not restrict the driver's field of vision.

The coat hooks in the vehicle should be used only for lightweight clothing. Never leave any heavy, hard or sharp objects in the pockets.

 NOTICE

Each coat hook may be loaded with a maximum of 2.5 kg.

Drink holders

 Introduction

This chapter contains information on the following subjects:

⇒ Drink holder in the rear centre armrest

Bottle holders

Bottle holders for bottles up to a maximum volume of 1.5 l are located in the stowage compartments in the driver and front passenger door.

 WARNING

Incorrect use of the drink holders can cause injury.

Never place hot drinks in a drink holder. Hot drinks in a drink holder could be spilled and cause scalding in any sudden braking manoeuvre or accident.

Ensure that drink bottles or any other objects do not enter the driver footwell and obstruct the pedals while the vehicle is in motion.

Never place heavy cups, food or any other heavy items in the drink holders. These heavy objects could be flung through the vehicle interior during an accident and cause serious injuries.

 WARNING

Closed drink bottles can explode in the vehicle in extreme heat or crack in extremely cold temperatures.

Never leave closed drink bottles in an extremely hot or extremely cold vehicle for extended periods.

 NOTICE

Do not leave any open drinks in the drink holder while the vehicle is in motion. Drinks that are spilled, for example during braking, can damage the vehicle and the vehicle electrical system.



The inserts for the drink holders can be removed for cleaning purposes.

Drink holder in the rear centre armrest

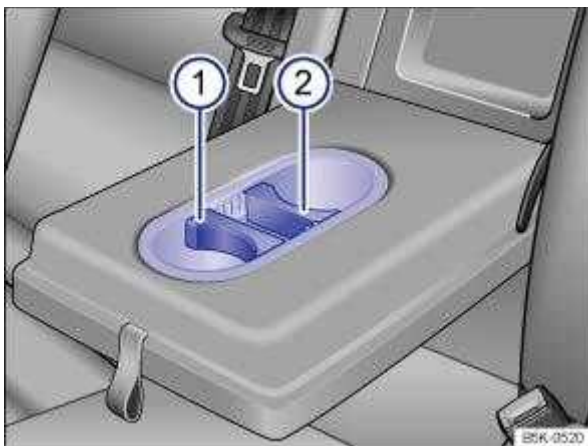

Fig. 138 In the rear centre armrest: drink holder.



First read and observe the introductory information and safety warnings ⇒  Introduction

To use: fold the centre armrest down.

To adjust to the size of the drinking vessel: pull out the inserts ⇒ Fig. 138 ① or ② upwards and insert them to fit the size of the vessel.

Fold the centre armrest back up again when the drink holder is no longer in use.



Small or rectangular containers will fit into the drink holders better if you rotate the insert by 180°.

Ashtray and cigarette lighter

Removable ashtray in the drink holder

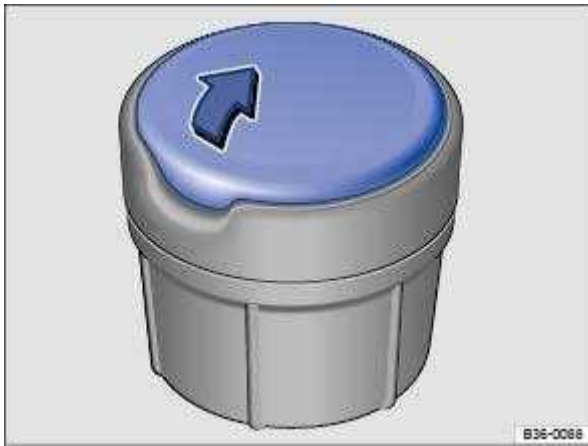

Fig. 139 Removable ashtray.

To use the removable ashtray, place it in one of the drink holders in the lower part of the centre console or in the rear centre armrest ⇒ Drink holders .

Opening and closing the removable ashtray

To open: lift up the cover of the ashtray ⇒ Fig. 139 ⇒ ⚠ .

To close: press the ashtray cover down.

Emptying the removable ashtray

Lift the removable ashtray out of the drink holder.

Open the removable ashtray and empty the cooled ashes into a suitable waste container.

Once it has been emptied, place the removable ashtray back into the drink holder from above.

⚠ WARNING

Improper use of the ashtray can cause fires, burns and other serious injuries.

Never put paper or any other combustible materials in the ashtray.

Cigarette lighter



Fig. 140 In the front centre console: cigarette lighter.

With the ignition switched on, press in the knob on the cigarette lighter.

Wait for the lighter to pop out.

Pull out the cigarette lighter and light the tobacco product on the glowing spiral ⇒ ⚠ .

Insert the cigarette lighter back into the socket.

 WARNING

Improper use of the cigarette lighter can cause fires, burns and other serious injuries.

Always use the cigarette lighter properly, and only use it to light tobacco products.

Never leave children unsupervised in the vehicle. The cigarette lighter can be used when the ignition is switched on.



The cigarette lighter socket can also be used as a 12-volt socket ⇒ Electrical sockets .

Electrical sockets



Introduction

This chapter contains information on the following subjects:

⇒ Electrical sockets in the vehicle

Electrical equipment can be connected to the sockets in the vehicle.

The electrical devices must be in good condition. Do not use faulty devices.

The 12-volt socket will work only when the ignition is switched on.

 WARNING

Improper use of the sockets and electrical accessories can cause fires and severe injuries.

Never leave children unsupervised in the vehicle. Sockets and the devices connected to them can be used when the ignition is switched on.

If the electrical device gets too hot, switch off the device immediately and disconnect it from the socket.

 NOTICE

In order to prevent damage to the electrical system, never connect equipment that supplies electric power, such as solar panels or battery chargers for charging the 12-volt battery, to the 12-volt socket.

Use only electrical devices that have been approved in accordance with current guidelines concerning electromagnetic compatibility.

In order to avoid damage due to voltage fluctuations, always switch off any electrical devices before switching the ignition on or off and before starting the engine. When the start/stop system

automatically switches off and restarts the engine, it is not necessary to switch off any connected electrical consumers.

Never connect electrical devices requiring more than the rated power to a 12-volt socket. The vehicle's electrical system can be damaged if the maximum power consumption is exceeded.

Observe the operating instructions of the electrical devices!



Using electrical consumers with the engine switched off and the ignition switched on will drain the 12-volt battery.



Unshielded devices can cause interference in the Infotainment system and vehicle electronics.

Electrical sockets in the vehicle

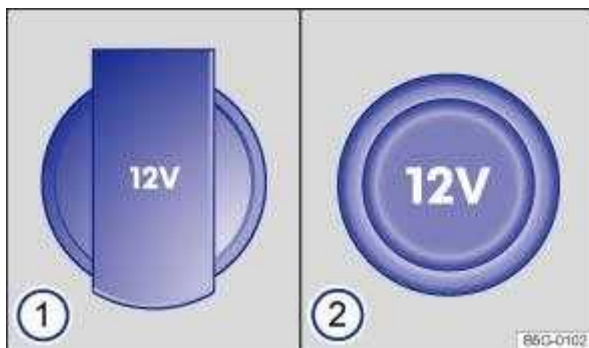

Fig. 141 In the front part of the centre console and in the rear centre console: 12-volt socket with hinged flap ① or 12-volt socket with removable cover ②.



First read and observe the introductory information and safety warnings ⇒ ⚠ Introduction

Maximum power rating

Electrical socket	Maximum power rating
12 volts	120 watts

The maximum power rating of the individual sockets must never be exceeded. The power rating of each device is stated on its type plate.

If there are several sockets in the vehicle and two or more devices are connected at the same time, the overall power consumption of all connected electrical devices must never exceed 190 W ⇒ ⚠ .

Multimedia

Subwoofer

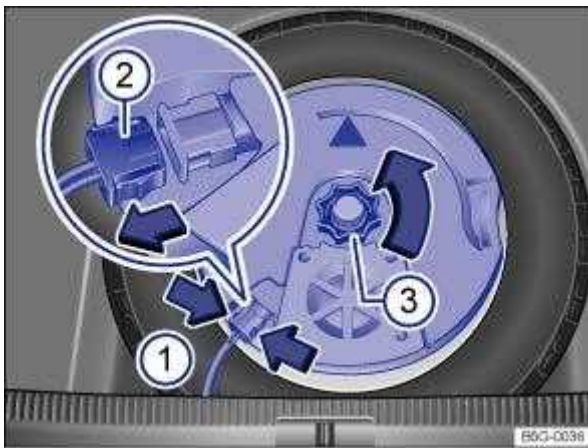

Fig. 142 In the luggage compartment: removing subwoofer (type 1).

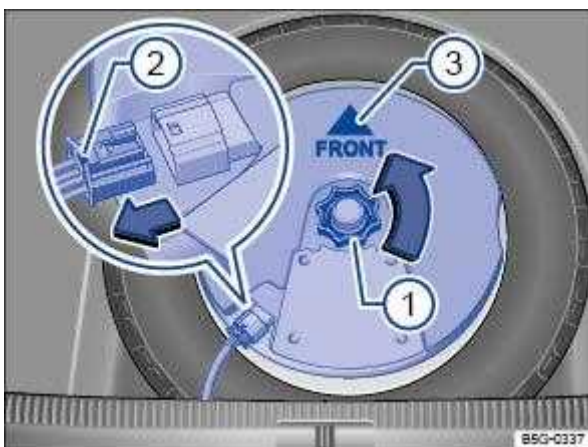

Fig. 143 In the luggage compartment: removing subwoofer (type 2).

The subwoofer must be removed before the spare wheel can be taken out.

Removing the subwoofer (type 1)

Lift up the variable luggage compartment floor until it is held in position by the side restraints.

To release the connector ⇒ Fig. 142② , press the lugs together ⇒ Fig. 142 (arrow ①).

Pull off the connector ⇒ Fig. 142② in the direction of the arrow and place the disconnected the electrical cable to one side.

Unscrew handwheel ⇒ Fig. 142③ in direction of arrow.

Lift out the subwoofer carefully.

Removing the subwoofer (type 2)

Lift up the variable luggage compartment floor until it is held in position by the side restraints.

Unscrew handwheel ⇒ Fig. 143① in direction of arrow.

To unlock the connector, press the catch on the end of the plug ⇒ Fig. 143② .

Pull out the connector as shown by the arrow, and place the disconnected electrical cable to one side.

Lift out the subwoofer carefully.

Installing the subwoofer (type 1)

Place the subwoofer carefully in the rim base. The tip of the arrow symbol FRONT on the subwoofer must face forwards.

Plug in connector ⇒ Fig. 142 ② until it audibly engages.

Screw the handwheel ⇒ Fig. 142 ③ onto the threaded pin in the opposite direction to the arrow until the subwoofer is properly secured.

Place the variable luggage compartment floor on the floor covering.

Installing the subwoofer (type 2)

Place the subwoofer carefully in the rim base. The tip of the arrow symbol FRONT ⇒ Fig. 143 ③ on the subwoofer must face forwards.

Plug in connector ⇒ Fig. 143 ② until the catch audibly engages.

Screw the handwheel ⇒ Fig. 143 ① onto the threaded pin in the opposite direction to the arrow until the subwoofer is properly secured.

Place the variable luggage compartment floor on the floor covering.

Mobile online services

Volkswagen Car-Net



Introduction

This chapter contains information on the following subjects:

⇒ Legal requirements

⇒ Deactivating Car-Net services

⇒ Service impairment or interruption

⇒ Apps

Volkswagen Car-Net is not available in all countries and is subject to country-specific limitations on duration of use.

Volkswagen Car-Net allows you to communicate with your vehicle in order to exchange data, request information or control functions.

In order to be able to use Volkswagen Car-Net, the vehicle has to be ordered with Car-Net and factory-fitted with the system. Depending on the service or service portfolio, Volkswagen Car-Net can be operated via the factory-fitted Infotainment system, via a Car-Net portal on the Internet or using a mobile device.

Information about the Volkswagen Car-Net services, applications, availability, compatible mobile devices and service portfolio, as well as service descriptions, are available on the Volkswagen website:

In Europe and Japan: www.volkswagen.com/car-net

In China: www.vwcarnet.com.cn

Before using the Volkswagen Car-Net services for the first time, please read and observe the information in the relevant service description. This will quickly help you to become familiar with the services and make you aware of potential risks to yourself and others, and how to avoid them.

 WARNING

Accidents and injuries can occur if the driver is distracted.

Always drive carefully and responsibly.

 WARNING

Failure to observe the information in the service description can lead to your vehicle breaking down in traffic, and can cause accidents and serious injuries.

Always use the most up-to-date edition of the relevant service descriptions which is available on the Volkswagen website.

 WARNING

The following conditions can make it impossible to make a telephone call, run a Volkswagen Car-Net service or transfer data:

If your current location is in an area with no or insufficient mobile communications and GPS reception. This can also include tunnels, streets with tall buildings, garages, multi-storey car parks, underpasses, mountains and valleys.

If you are in an area with sufficient mobile communications and GPS reception but the telecommunications provider's mobile network is overloaded, out of order or unavailable.

If the components in the vehicle required for the services and data transmission are damaged, not working or do not have sufficient electrical power.

The battery for the mobile device is empty, does not have a sufficient charge level or has no more call credit.

 WARNING

Using computers and mobile devices in public or non-secured LAN and WLAN networks can lead to a loss of control over your Volkswagen Car-Net services.

In addition to the usual precautionary measures to be taken when using the Internet, you should protect your computer and mobile device with suitable anti-virus software and regularly update its signatures.

Protect your login data for the Car-Net portal, your computer and mobile device against misuse.

 WARNING

Applications and Volkswagen Car-Net services which are unsuitable or faulty or that are used incorrectly can cause damage to the vehicle, accidents or serious injury.

Never make changes to applications or Volkswagen Car-Net services.

 NOTICE

Volkswagen is not responsible for damage to the vehicle caused by poor quality or faulty third-party applications, insufficient programming of applications, insufficient network strength, loss of data during transmission or through misuse of your computers, tablets or mobile devices.

Legal requirements



Fig. 144 Symbol for vehicles that send tracking information

 First read and observe the introductory information and safety warnings ⇒  Introduction

By concluding a Volkswagen Car-Net contract for your vehicle, you as the contracting party undertake within the meaning of data protection law to inform each driver that the vehicle can transmit and receive data online. This also applies if you sell or lend your vehicle.

Failure to observe this obligation to inform can infringe certain rights of vehicle occupants.

GPS tracking: check with all occupants

Some Volkswagen Car-Net services require vehicle data to determine whether the vehicle is complying with set speed limits, where the vehicle is parked, or whether the vehicle is located within a defined area. This information can be displayed in the Car-Net portal and in the Volkswagen Car-Net app.

Therefore, before setting off, ask all occupants if they agree to use of the activated services. If an occupant does not agree, deactivate the service (if possible) or exclude the occupant from use of the vehicle. If you do not observe this, you may violate certain rights of the vehicle occupants.

GPS tracking: symbol

If a factory-fitted control unit is used to transmit the vehicle's current location and speed, this symbol ⇒ Fig. 144 will always be located in the vehicle (e.g. on the roof console). However, the

absence of the ⇒ Fig. 144 symbol in the vehicle does not mean that the control unit is not transmitting the current position or speed of the vehicle.

Personal data

Volkswagen collects, processes and uses the user's personal data in accordance with statutory requirements. You can access the current data protection policy on the Volkswagen homepage.

Deactivating Car-Net services



Fig. 145 Retrofitted sticker in the vehicle if Volkswagen Car-Net services have been permanently deactivated.



First read and observe the introductory information and safety warnings ⇒ Introduction

If you sell the vehicle or lend it for a longer period, inform the user about the deactivated services and deactivated control unit.

If your vehicle is already equipped with the legally required emergency call function eCall, this function will not be affected by the deactivation described here.

Temporary deactivation

If your vehicle is in a workshop, you may find that the service technicians have deactivated individual or all services for the duration of the workshop visit. The services will be available again once the work is complete. Please contact your workshop if necessary. Volkswagen Car-Net portfolios can be deactivated manually in the Infotainment system. The services can then be run again when the deactivation is cancelled in the Infotainment system. Deactivated services are marked with a corresponding indication on the start page of the Car-Net portal.

Permanent deactivation

In order to permanently deactivate Car-Net functions in vehicles with the Security & Service or e-Remote packages, the online connectivity unit must be deactivated by a qualified workshop at your request.

Once the on-board connectivity unit has been deactivated, the workshop will attach a sticker ⇒ Fig. 145 to your vehicle (e.g. on the roof console). The sticker shows that neither the Volkswagen emergency call service nor the automatic accident notification will work. All other e-Remote and Security & Service services will also be deactivated.

Service impairment or interruption



First read and observe the introductory information and safety warnings ⇒ Introduction

Even when the above-mentioned requirements for using the services are met, the functionality of the Car-Net services can be impaired or interrupted due to factors that lie outside the control of Volkswagen AG. Such factors include in particular:

Maintenance, repairs, software updates and technical changes to your service provider's telecommunication systems, satellites, servers and databases.

The telecommunications provider has changed the mobile telecommunication standard for transferring mobile data, e.g. from UMTS to EDGE or GPRS

An existing mobile telecommunications standard has been shut down by the telecommunications provider.

Impairment or interruption to mobile and GPS reception, e.g. due to high speeds, solar storms, weather, landscape, interfering devices or intensive use of the mobile network in the relevant cells.

Restricted availability, completeness or correctness of information provided by third parties, e.g. maps.

Countries where Volkswagen Car-Net services are not available.

Apps



First read and observe the introductory information and safety warnings ⇒ Introduction

The Volkswagen Car-Net app can execute Volkswagen Car-Net services in the vehicle and provide information.

Volkswagen App-Connect allows content from Volkswagen apps and third party apps on mobile devices to be shown on the Infotainment system screen.

There may be problems with compatibility with third party apps.

A wide range of applications may be available and they may be vehicle-specific and country-specific ⇒ . Content, range and provider of applications can vary. Some applications also depend on availability of services offered by third parties.

We are unable to guarantee that the available apps can be run on all mobile devices and all operating systems.

Applications offered by Volkswagen can be changed, discontinued, deactivated, reactivated and expanded without prior notice.

Transporting items

Stowing luggage and loads

Cargo and luggage can be transported in the vehicle, on a trailer ⇒ Technical requirements and on the roof ⇒ Roof carrier . Always observe the legal regulations.

Stowing luggage safely in the vehicle

Always distribute any loads in the vehicle as evenly as possible.

Always stow luggage and heavy objects in the luggage compartment ⇒  .

Place heavy objects as far forward in the luggage compartment as possible.

Observe gross axle weight ratings and the gross vehicle weight rating ⇒ Technical data .

Secure luggage to the fastening rings in the luggage compartment using suitable lashing, fixing and securing straps ⇒ Luggage compartment equipment .

Also stow small objects safely.

If necessary, fold back the rear seat backrest and engage it securely.

If necessary, adjust the headlight range ⇒ Headlights .

Adjust the tyre pressure according to the vehicle load. Observe the tyre pressure sticker ⇒ Tyre pressure .

In vehicles with a tyre monitoring system, set the new vehicle load level as necessary ⇒ Tyre monitoring system .

WARNING

Objects that are not secured, or are secured incorrectly, can cause serious injuries in the event of a sudden driving or braking manoeuvre or accident. This applies particularly if objects are struck by an airbag when activated and then flung through the vehicle interior. Please observe the following rules to reduce the risk of accidents:

Always stow all objects in the vehicle securely.

Small and light objects should also be secured.

Objects should be stowed in the vehicle interior in such a way that they can never enter the airbag deployment zones while the vehicle is in motion.

Always keep stowage compartments closed while the vehicle is in motion.

Stowed objects must never cause passengers to assume an incorrect sitting position.

If an item is being stowed on a seat, this seat must not be used by any passengers.

Do not stow any hard, heavy or sharp objects loose in any of the vehicle's open stowage areas, on the surface behind the rear seat backrest or on the dash panel.

Remove any hard, heavy or sharp objects from items of clothing and bags inside the vehicle and stow them securely.

WARNING

Transporting heavy objects changes the vehicle's handling and increases the braking distance. Heavy loads that are not properly stowed or secured in the vehicle can lead to a loss of vehicle control and can cause serious injury.

Never exceed the vehicle's maximum payload. Both the payload and the distribution of the load in the vehicle will have an effect on the handling and braking distance of the vehicle.

Transporting heavy objects changes the vehicle's handling and the centre of gravity.

The load should be distributed as evenly as possible in the vehicle.

Always secure heavy objects in the luggage compartment as far in front of the rear axle as possible.

Loose objects in the luggage compartment can suddenly slide and change the way the vehicle handles.

Always adapt your speed and driving style to suit visibility, weather, road and traffic conditions.

Accelerate very carefully and gently.

Avoid sudden braking and driving manoeuvres.

Brake earlier than in normal driving.

⚠ NOTICE

Objects rubbing against the rear windows may damage or destroy the heating wires or, depending on the vehicle equipment, also the aerial.

Luggage compartment cover



Fig. 146 In the luggage compartment: removing and installing the luggage compartment cover.

When the boot lid ⇒ Boot lid is opened and closed, the luggage compartment cover is also raised and lowered if the retaining straps are attached.

Light items of clothing can be placed on the luggage compartment cover. Make sure that the view to the rear of the vehicle is not obstructed.

Removing the luggage compartment cover

Unhook the retaining straps from the boot lid ⇒ Fig. 146 (upper arrows).

Pull the luggage compartment cover out of the side retainers ⇒ Fig. 146 (lower arrows).

Installing the luggage compartment cover

Push the luggage compartment cover into the side retainers ⇒ Fig. 146 (lower arrows).

Hook the retaining straps onto the boot lid ⇒ Fig. 146 (upper arrows).

 **WARNING**

Objects that are not secured or secured incorrectly or animals on the luggage compartment cover may cause severe injuries in the event of sudden driving or braking manoeuvres or accidents.

Do not stow any hard, heavy or sharp items on the luggage compartment cover either loosely or in bags.

Do not transport animals on the luggage compartment cover.

 **NOTICE**

To prevent damage to the luggage compartment cover, do not load the luggage compartment to such a height that the luggage compartment cover presses against the load when the boot lid is closed.

Luggage compartment floor

Luggage compartment floor – Functions



Fig. 147 In the luggage compartment: opening the luggage compartment floor.



Fig. 148 In the luggage compartment: locking the luggage compartment floor.

Opening the luggage compartment floor

Grip the recessed handle in the luggage compartment floor ⇒ Fig. 147 and lift it upwards.

To lock in position, lift up the luggage compartment floor until it is held in position by the side restraints ⇒ Fig. 148 (close-up).

Closing the luggage compartment floor

Place the luggage compartment floor on the side supports ⇒ ⓘ .

ⓘ NOTICE

Never drop the luggage compartment floor; guide it slowly back down. The trims or the luggage compartment floor could otherwise be damaged.

Variable luggage compartment floor



Fig. 149 In the luggage compartment: opening the luggage compartment floor.

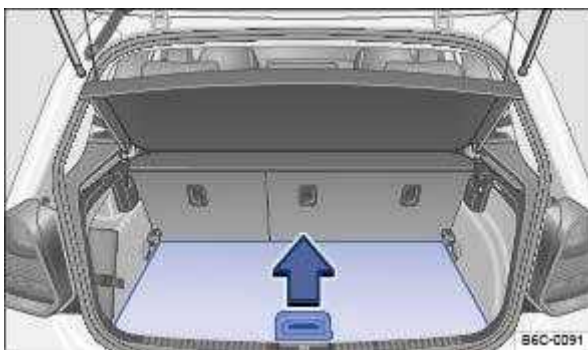

Fig. 150 In the luggage compartment: lowering the luggage compartment floor.

Opening the luggage compartment floor

Grip the recessed handle in the luggage compartment floor and lift it upwards ⇒ Fig. 149 .

To lock in position, lift up the luggage compartment floor until it is held in position by the side restraints.

Closing the luggage compartment floor

Place the luggage compartment floor on the side supports ⇒ ⓘ .

Lowering the luggage compartment floor

Lift back the luggage compartment floor and push it under the guides ⇒ Fig. 150 (arrows).

Place the luggage compartment floor on the floor covering.

 NOTICE

Never drop the luggage compartment floor; guide it slowly back down. The trims or the luggage compartment floor could otherwise be damaged.

 NOTICE

In the upper position, the variable luggage compartment floor has a maximum load capacity of 120 kg.



Depending on the vehicle equipment, there may be compartments for stowing small items under the luggage compartment floor.

Luggage compartment equipment

Fastening rings

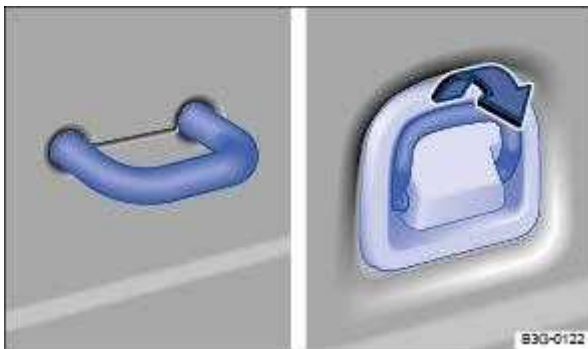

Fig. 151 In the luggage compartment: fixed and folding fastening rings.

There are fastening rings ⇒ Fig. 151 at the front and rear of the luggage compartment which can be used to secure loose items and luggage with the help of lashing, retaining or securing straps.

 WARNING

Unsuitable or damaged lashing, retaining or securing straps could tear in the event of a braking manoeuvre or accident. This could cause objects to be flung through the vehicle interior and lead to severe or fatal injuries.

Always use suitable and undamaged lashing, retaining or securing straps.

Pull lashing, retaining and securing straps taut crosswise over the cargo on the luggage compartment floor and attach securely to the fastening rings.

Never exceed the maximum load rating of the fastening rings when securing objects.

Make sure that the upper edge of the load is higher than the fastening rings, particularly when stowing flat objects.

Depending on the vehicle equipment, observe the signs about stowing loads that are attached in the luggage compartment.

Never secure a child seat to the fastening rings.



The maximum load rating of the fastening rings is approximately 3.5 kN.



Suitable lashing, retaining or securing straps and luggage securing systems are available from qualified workshops. Volkswagen recommends using a Volkswagen dealership for this purpose.

Bag hooks

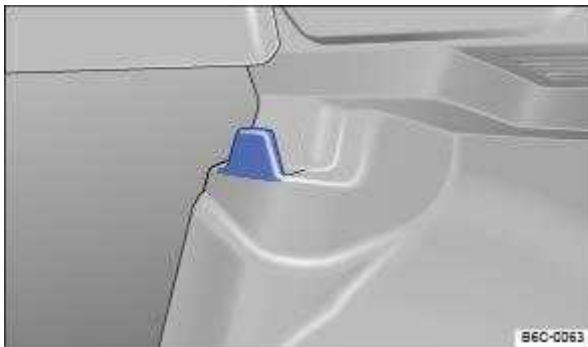

Fig. 152 In the luggage compartment: bag hook.

Bag hooks may be located on the left and right-hand sides of the luggage compartment ⇒ Fig. 152 .

 **WARNING**

Never use the bag hooks for lashing down items of luggage or other objects. The bag hook could break off during a sudden braking manoeuvre or in the event of an accident.

 **NOTICE**

Do not load each bag hook with more than 2.5 kg.

Load-through hatch

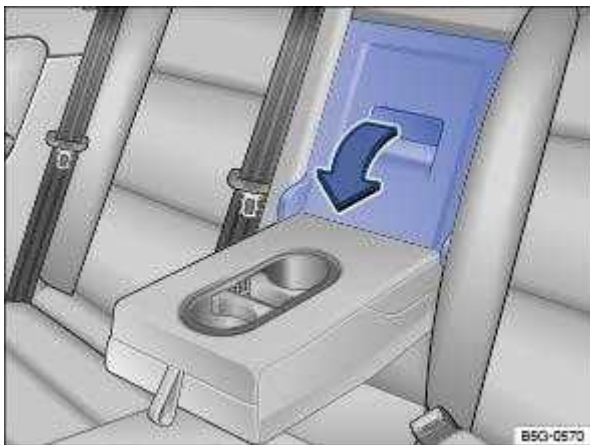

Fig. 153 In the rear seat backrest: opening the load-through hatch.

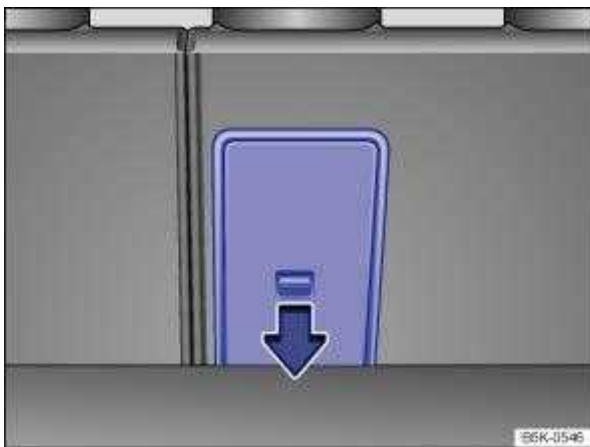

Fig. 154 In the luggage compartment: opening the load-through hatch.

Depending on the vehicle equipment, a load-through hatch may be located behind the centre armrest on the rear seat backrest. This can be used to transport long objects in the vehicle interior, such as skis.

Opening the load-through hatch

Fold the centre armrest forwards ⇒ Seat functions .

Opening the load-through hatch from the vehicle interior: pull the release lever in the direction of the arrow ⇒ Fig. 153 and fold the cover of the load-through hatch fully forward ⇒ ⚠ .

Open the boot lid.

OR: opening the load-through hatch from the luggage compartment: push the release lever down in the direction of the arrow ⇒ Fig. 154 and push the cover of the load-through hatch forward.

Push long objects through the load-through hatch from the luggage compartment.

Secure the objects with the seat belt as required.

Close the boot lid.

 **WARNING**

Injuries could be caused if the load-through hatch is folded forwards or backwards carelessly or in an uncontrolled way.

Never fold the load-through hatch forwards or backwards while the vehicle is in motion.

Ensure that the seat belt is not trapped or damaged when folding back the load-through hatch.

Always keep hands, fingers, feet and other body parts away from the swivel area when folding the load-through hatch forwards and backwards.

The load-through hatch has not been secured properly if the red marking can still be seen on the locking indicator. Always ensure that the red marking is never visible when the load-through hatch is in the upright position.

Passengers (children in particular) must not use this seat if the load-through hatch is folded forward or is not engaged securely into place.

Roof carrier



Introduction

This chapter contains information on the following subjects:

⇒ Securing roof carriers

⇒ Loading roof carriers

⇒ Notes on use

Depending on the model, the vehicle may be designed for fitting a roof carrier.

Roof carriers can be used to transport bulky items on the roof of the vehicle.

If you are unsure whether a roof carrier can be fitted on your vehicle, please contact a specialist workshop. Volkswagen recommends using a Volkswagen dealership for this purpose.

Only roof carriers that have been approved by Volkswagen for the vehicle must be used.

If the vehicle is not approved for use with a roof carrier, do not use or retrofit a roof carrier.



WARNING

When transporting heavy or bulky objects on the roof carrier, the vehicle's handling will change due to a shift in the centre of gravity and an increased susceptibility to crosswinds.

Always secure loads properly using suitable and undamaged lashing, retaining or securing straps.

Loads that are large, heavy, bulky, long or flat will have a negative effect on the vehicle aerodynamics, centre of gravity and overall handling.

Avoid abrupt and sudden driving and braking manoeuvres.

Always adapt your speed and driving style to suit visibility, weather, road and traffic conditions.

 WARNING

A roof carrier that has not been approved for the vehicle or a roof carrier that is fitted to a vehicle that is not approved for use with a roof carrier may cause accidents or injuries.

Use only roof carriers that have been approved by Volkswagen for your vehicle type.

Never use a roof carrier on a vehicle that has not been approved for use with a roof carrier.

A roof carrier that is fitted nevertheless may become loose whilst the vehicle is in motion and fall from the vehicle roof.

 NOTICE

Securing a roof carrier of any kind to a vehicle that is not approved for use with a roof carrier may lead to severe damage to the vehicle.

Securing roof carriers



First read and observe the introductory information and safety warnings ⇒  Introduction

Special roof carriers must be used to transport luggage, bicycles, skis, surfboards or boats safely ⇒  . Suitable accessories are available from your Volkswagen dealership.

Attaching the roof bars and load carrier

Mount roof bars to the roof railing according to the installation instructions provided.

Once you have fitted the roof bars, you can then secure the respective carrier system on them.

 WARNING

Incorrectly attaching and using the roof bars and load carrier could cause the whole roof carrier to fall off the roof. This could cause accidents and injuries.

Only use roof bars and load carriers when they are undamaged and fitted correctly.

Always fit roof bars and load carriers correctly. Always observe the installation instructions provided by the manufacturer.

Attach the roof bars only at the specified mounting points.

Special roof carriers for items such as bicycles, skis, surfboards etc. should always be properly installed. Always observe the installation instructions provided by the manufacturer.

Check that the roof carrier is secured before starting your journey and tighten as necessary after driving a short distance. During a long trip, check all screw connections and fasteners at each stop.

Do not carry out any modifications or repairs to the roof bars or the load carrier.

Loading roof carriers



First read and observe the introductory information and safety warnings ⇒ ⚠ Introduction

Maximum permitted roof load

The maximum permitted roof load is 75 kg.

The roof load limit refers to the combined weight of the roof carrier and the load carried on the roof ⇒ ⚠ .

Make sure you are aware of the weight of the roof carrier system and the load to be transported. Weigh the load if necessary.

However, you will not be able to carry the maximum permitted roof load if you are using a roof carrier with a lower load rating. In this case, do not exceed the maximum weight limit for the load carrier system which is specified in the manufacturer's installation instructions.

Distributing the load

Distribute the load evenly and secure it correctly ⇒ ⚠ .



WARNING

Accidents and significant vehicle damage can occur if the maximum permitted roof load is exceeded.

Never exceed the stated roof load, the maximum permissible axle loads, and the permissible gross vehicle weight for the vehicle.

Do not exceed the load rating of the roof carrier, even if the maximum roof load has not been reached.



WARNING

Loose and incorrectly secured loads can fall off the roof carrier and cause accidents and injuries.

Always use suitable and undamaged lashing, retaining or securing straps.



NOTICE

When opening the boot lid, take care not to let it hit the roof load.

Notes on use



First read and observe the introductory information and safety warnings ⇒ ⚠ Introduction

Remove the roof carrier in the following situations

The roof carrier is no longer needed.

Before driving through an automatic car wash.

The vehicle height exceeds the required clearance height, e.g. in a garage.

NOTICE

Always remove the roof carrier before driving through an automatic car wash.

The height of the vehicle is changed by the installation of a roof carrier and the load secured to it. Check and compare the height of the vehicle with clearance heights, e.g. for underpasses and garage doors.

The roof carrier and its load must not obstruct you from opening and closing the glass roof and the boot lid. The roof aerial must also remain unaffected.



Driving with a fitted roof carrier will increase air resistance and thus increase fuel consumption.

Trailer towing



Introduction



This chapter contains information on the following subjects:

- ⇒ Technical requirements
- ⇒ Fitting the removable ball head
- ⇒ Removing the ball head
- ⇒ Notes on towing a trailer
- ⇒ Loading the trailer
- ⇒ Driving with a trailer
- ⇒ Trailer stabilisation
- ⇒ Retrofitting a towing bracket

The vehicle can be used to tow a trailer if it has the required technical equipment for this. The additional trailer load will affect the amount of wear, fuel consumption and performance of the vehicle and, in certain circumstances, could shorten the service intervals.

Driving with a trailer not only places an extra load on the vehicle, but also requires increased concentration on the part of the driver.

Vehicles with start/stop system

When using towing brackets that were not retrofitted by Volkswagen, the start/stop system must be deactivated manually using the  button in the centre console before towing a trailer, and it must remain deactivated for as long as a trailer is being towed ⇒ .

 DANGER

It is dangerous to transport people in a trailer and it may also be illegal.

 WARNING

Improper use of the towing bracket can lead to a loss of vehicle control, accidents and serious injuries.

Only use the towing bracket if it is fitted properly and is not damaged.

Do not carry out any alterations or repairs to the towing bracket.

Wherever possible, swivel in or remove the ball head when a trailer is not being used in order to reduce the risk of injury in rear-end collisions, and the risk of injury to pedestrians and cyclists when the vehicle is parked.

Never install a weight-distributing or load-balancing towing bracket to the vehicle. The vehicle is not designed for these kinds of towing brackets. The towing bracket can fail, causing the trailer to tear loose from the vehicle.

 WARNING

Towing a trailer and transporting heavy or bulky items can change the vehicle handling and increase the braking distance. This can lead to accidents.

Always secure loads properly using suitable and undamaged lashing, retaining or securing straps.

Always adapt your speed and driving style to suit visibility, weather, road and traffic conditions. Reduce your speed, particularly when going downhill.

Trailers with a high centre of gravity are more likely to tip over than trailers with a low centre of gravity.

Always drive carefully and think ahead. Accelerate very carefully and gently. Avoid abrupt and sudden driving and braking manoeuvres.

Take special care when overtaking. Reduce your speed immediately if the trailer shows even the slightest sign of snaking.

Never drive faster than 80 km/h (50 mph) when towing a trailer, also 100 km/h (60 mph) in exceptional cases. This also applies to countries where higher speeds are permitted. Keep to country-specific speed limits, which may be lower for vehicles with trailers than for vehicles without trailers.

Never try to stop a trailer from snaking by increasing your speed.

Never install a weight-distributing or load-balancing towing bracket on the vehicle.

 WARNING

The start/stop system must always be switched off manually when towing a trailer using towing brackets that have not been retrofitted by Volkswagen. Otherwise faults can occur in the brake system, possibly resulting in accidents and serious injuries.

 NOTICE

Observe the instructions and information for vehicles with an N1 approval ⇒ Information about vehicles with N1 approval (light commercial vehicle) .



Always switch off the anti-theft alarm before a trailer is hitched or unhitched or a bicycle carrier is loaded or unloaded ⇒ Anti-theft alarm . The tilt sensor could otherwise trigger an alarm unintentionally.



With a new engine, do not tow a trailer during the first 1,000 km ⇒ Running in the engine .



Some retrofitted towing brackets may cover the aperture for fitting the towing eye. If so, the towing eye cannot be used for towing or tow-starting other vehicles. For this reason, the removed ball head of a retrofitted towing bracket should be kept in the vehicle at all times.

Technical requirements



First read and observe the introductory information and safety warnings ⇒  Introduction

Cooling system

There is an increased load on the engine and the cooling system when towing a trailer. The cooling system must contain sufficient coolant and be able to cope with the extra load due to trailer towing.

Trailer brake

If the trailer is equipped with its own brake system, comply with the relevant regulations.

Trailer tail light clusters

The trailer tail light clusters must work correctly and meet legal requirements. Do not exceed the maximum power consumption for the trailer.

Exterior mirrors

If you are unable to see the traffic behind the trailer using the vehicle's standard exterior mirrors, additional exterior mirrors should be fitted in accordance with any country-specific regulations. Before setting off, adjust the exterior mirrors so that you have a sufficient view towards the rear.

Retrofitting a towing bracket

Only use a towing bracket which has been approved by Volkswagen for your vehicle type. Always check and observe the data provided by the towing bracket manufacturer.

Maximum power consumption of the trailer's electrical consumers

Never exceed the specified values.

Europe, Asia, Africa, South and Central America	
All brake lights	84 watts
Turn signal per side	42 watts
All side lights	100 watts
All tail lights	42 watts
Rear fog light	42 watts

Australia	
All brake lights	108 watts
Turn signal per side	54 watts
All side lights	100 watts
All tail lights	54 watts
Rear fog light	54 watts

WARNING

If the towing bracket is unsuitable or incorrectly fitted, the trailer could become detached from the towing vehicle. This can cause serious accidents and fatal injuries.

Never fit a towing bracket to the rear bumper or its mountings. The towing bracket must not prevent the rear bumper from functioning correctly.

Do not carry out any alterations to the exhaust or brake systems.

NOTICE

The vehicle electronics system may be damaged if the trailer's power consumption is too high.

Never connect the trailer's electrical system directly to the electrical connections of the tail light clusters or to other power sources. Use only suitable connectors to supply power to the trailer.



Towing a trailer places additional demands on the vehicle. Volkswagen recommends additional services between the normal inspection intervals if the vehicle is used frequently for towing a trailer.

Fitting the removable ball head

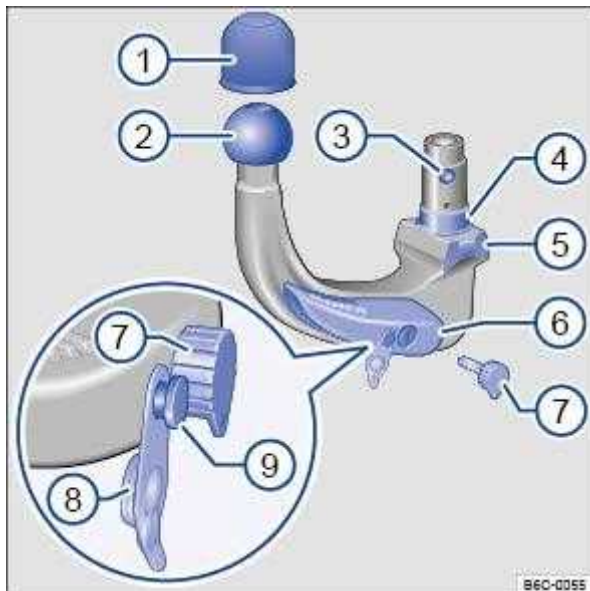

Fig. 155 Overview: removable ball head.



First read and observe the introductory information and safety warnings ⇒ ⚠ Introduction

Key to ⇒ Fig. 155

- ① Protective cap 1)
- ② Ball head
- ③ Retaining balls
- ④ Shank
- ⑤ Centring device
- ⑥ Release lever
- ⑦ Keys
- ⑧ Lock cap

⑨ Release pin with coloured marking

The removable ball head is located with the vehicle toolkit in the luggage compartment.

Step 1: preparations

Remove the cap from the ball head mounting under the rear bumper ⇒ Rear view and stow in the vehicle.

Starting from the bottom right side, swivel the trailer socket as far as possible to the top left. This gives you access to the ball head mounting.

Check to ensure that the mounting, locking lever ⇒ Fig. 155 ⑥, shank ④ and the retaining balls ③ of the ball head are all clean and not damaged ⇒ ①. Clean if necessary.

Step 2: check whether the ball head is pre-tensioned

The ball head cannot be fitted properly unless it is pre-tensioned.

The following conditions must be fulfilled:

The lock cover ⇒ Fig. 155 ⑧ is open and the key ⑦ is inserted

The release pin ⑨ can be moved.

The locking lever ⑥ is in the bottom position.

All retaining balls ③ can be pressed fully into the shank ④.

If all these conditions are met, continue with Step 4.

If conditions are not met, continue with Step 3.

Step 3: pre-tensioning the ball head

If the ball head is not pre-tensioned, pre-tension the ball head as follows:

Remove the lock cover ⑧ from the lock and insert the key ⑦ into the lock.

Turn the key ⑦ anti-clockwise until the part of the key with the hole is at the top.

Press the release pin ⑨ and at the same time press the locking lever ⑥ down as far as it will go ⇒ ⚠. The locking lever remains locked in this position.

Step 4: attaching the pre-tensioned ball head to the vehicle

Do not touch the locking lever once the ball head has been pre-tensioned. When the ball head is engaged, the locking lever will spring back to its original position and could cause injury ⇒ ⚠.

Guide the pre-tensioned removable ball head into the mounting tube from below.

Push the ball head firmly upwards until it engages. The centring devices ⇒ Fig. 155 ⑤ must engage in the mounting points on the vehicle.

The locking lever ⑥ automatically turns up to its original position and the green section of the release pin ⑨ is visible.

Turn the key ⑦ clockwise until the part of the lock with the holes is at the top.

Fit the lock cap ⑧ on the lock and place the key ⑦ in the vehicle toolkit.

Step 5: safety check

Before hitching a trailer, check if the ball head is fixed correctly.

The locking lever ⇒ Fig. 155 ⑥ is in the uppermost position.

The green section of the release pin ⑨ is visible.

Shake the ball head ② or pull it down with some force. It must sit firmly in the mounting ⇒ ⚠.

The lock must be locked and the key ⑦ removed.

The lock cover ⑧ must cover the lock in the locking lever.

WARNING

Improper use of the towing bracket can cause injuries and accidents.

☒ Use the ball head only if it is properly secured.

☒ If the smallest diameter of the ball ⇒ Fig. 155 ③ is less than 49 mm, do not use the towing bracket.

☒ The ball head is heavy. When checking whether it is secure, the ball head could fall off and cause injuries.

☒ Do not touch the locking lever once the ball head has been pre-tensioned. When the ball head is pressed into the mounting, the locking lever will spring back to its original position.

☒ If the ball head will not fit properly, the towing bracket should be checked by a qualified workshop.

☒ Do not use the towing bracket if the ball head does not engage properly or if you are unable to pre-tension it.

☒ Do not use the towing bracket if you are unable to remove the key from the locking lever once the ball head has been mounted. This means that ball head is not locked properly.

☒ Always fasten the ball head securely in the luggage compartment once it has been removed.

NOTICE

☒ The mounting on the vehicle, release lever, shank and ball head retaining balls must all be clean and undamaged. Otherwise you may not be able to lock the ball head securely.

☒ Do not aim a high-pressure hose or steam cleaner directly at the ball head mounting. This could wash the grease required for lubrication out of the mounting.

1) Not always included in the scope of delivery.

Removing the ball head



First read and observe the introductory information and safety warnings ⇒ ⚠ Introduction

- ☑ Bring the vehicle to a standstill and apply the electronic parking brake ⇒ Electronic parking brake .
- ☑ Switch off the engine.
- ☑ Uncouple the trailer and disconnect the electrical connection between the vehicle and the trailer. If fitted, remove adapters from the trailer socket.
- ☑ Remove the lock cover ⇒ Fig. 155 ⑧ from the lock in the locking lever and insert the key ⑦ into the lock.
- ☑ Turn the key ⑦ anti-clockwise until the part of the key with the hole is at the top.
- ☑ Hold the neck of the ball head under the ball head ② with your hand.
- ☑ Press the release pin ⑨ and at the same time press the locking lever ⑥ down as far as it will go ⇒ ⚠ . The ball head is pre-tensioned.
- ☑ Guide the removable ball head down and out of the mounting.
- ☑ Let go of the release lever ⑥ and stow the pre-tensioned ball head safely with the vehicle toolkit.
- ☑ Hold the neck of the ball head under the ball head ② with your hand.
- ☑ Pivot the trailer socket back fully from the bottom right to the top left to prevent soiling and damage to the mounting.
- ☑ Insert the cap into the ball head mounting.



WARNING

The removable ball head is heavy. The ball head could fall while it is being removed. This could cause injuries.

- ☑ Unlock the ball head only once the trailer has been unhitched.

Notes on towing a trailer

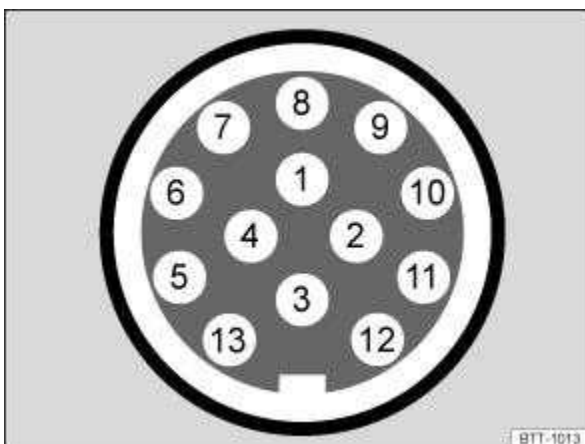



Fig. 156 Pin assignment for the trailer socket (illustration).



First read and observe the introductory information and safety warnings ⇒  Introduction

Pin assignment for the trailer socket ⇒ Fig. 156 :

- ① Left turn signal
- ② Rear fog light
- ③ Earth for pins 1, 2, 4, 5, 6, 7, 8
- ④ Right turn signal
- ⑤ Tail light, right
- ⑥ Brake light
- ⑦ Tail light, left
- ⑧ Reversing light
- ⑨ Permanent positive
- ⑩ Permanent positive
- ⑪ Earth for pin 10
- ⑫ Not assigned
- ⑬ Earth for pin 9

Trailer socket

A 13-pin trailer socket produces the electrical connection between the towing vehicle and the trailer. When the vehicle electrically detects a trailer, the consumers in the trailer are supplied with an electrical voltage via the electrical connection (pins 9 and 10). Pin 9 is assigned as the permanent positive, enabling operation of the trailer interior lighting, for example.

Electrical consumers such as a caravan refrigerator are supplied with power only when the engine is running (pin 10).

To avoid overloading the electrical system, do not connect the earth wires (pins 3, 11 and 13) with each other.

If the trailer has a 7-pin plug you will need to use a suitable adapter cable. The function of pin 10 is then not available.

If you are uncertain whether the trailer has been properly electrically connected to the towing vehicle, please contact a qualified workshop. Volkswagen recommends using a Volkswagen dealership for this purpose.

Connection to the anti-theft alarm

The trailer is integrated in the anti-theft system if the following conditions are fulfilled:

- ☐ When the vehicle has a factory-fitted anti-theft alarm and a factory-fitted towing bracket.
- ☐ When the trailer is electrically connected to the towing vehicle via the trailer socket.
- ☐ When the vehicle and trailer electrical systems are functional, fault-free and undamaged.
- ☐ When the vehicle is locked with the vehicle key and the anti-theft alarm is active.

When the vehicle is locked, the alarm will be triggered as soon as the electrical connection to the trailer is interrupted.

Connection to the anti-theft alarm (trailer with LED tail light clusters)

For technical reasons, trailers with LED tail light clusters cannot be integrated into the anti-theft alarm system.

When the vehicle is locked, the alarm is not triggered as soon as the electrical connection to the trailer with LED tail light clusters is interrupted.

WARNING

Any electrical cables which are not connected properly or are connected incorrectly could cause the trailer to become live. This could lead to malfunctions in the entire vehicle electronics system and could also cause accidents and serious injuries.

- ☐ All work on the electrical system should only be carried out by a qualified workshop.
- ☐ Never connect the trailer's electrical system directly to the electrical connections of the towing vehicle's tail light clusters or to other power sources.

WARNING

Contact between the pins in the trailer socket can lead to short circuits, overloading of the electrical system and failure of the lighting system, thereby causing accidents and serious injuries.

- ☐ Never connect the pins in the trailer socket to one another.
- ☐ Have bent pins repaired by a qualified workshop.

NOTICE

If you park the trailer using the support wheel or other trailer supports, the trailer must be unhitched from the vehicle. The vehicle could move up and down if the load changes or if there is damage to the tyres, for example. If this happens, a great deal of force will be exerted on the towing bracket and trailer, which could lead to damage to the vehicle and trailer.



If there is a fault in the vehicle or trailer electrical systems or in the anti-theft alarm, have the vehicle checked by a qualified workshop.



If the 12-volt vehicle battery charge level is low, the electrical connection to the trailer will be interrupted automatically.

Loading the trailer



First read and observe the introductory information and safety warnings ⇒  Introduction

Trailer weight and drawbar load

The trailer weight is the weight that the vehicle can pull ⇒  .

The drawbar load is the load that is exerted vertically from above onto the ball head of the towing bracket.

The figures for trailer weights and drawbar weights that are given on the data plate of the towing bracket are for certification purposes only. The correct values for your specific model, which may be lower than these figures, are given in the vehicle registration documents. All data in the official vehicle documents take precedence over these data.

The maximum permitted drawbar load exerted by the trailer drawbar on the ball head of the towing bracket must not exceed 80 kg.

In the interest of driving safety, Volkswagen recommends that you always use the maximum drawbar load. The handling of the vehicle combination will be impaired if the drawbar load is too low.

The drawbar load increases the weight on the rear axle and reduces the maximum payload of the vehicle as a result.

Gross combination weight

The gross combination weight is made up of the actual weight of the loaded vehicle and of the loaded trailer.

In some countries, trailers are divided into different classes. Volkswagen recommends that you contact a qualified workshop to find out about suitable trailers.

Loading the trailer

The weight of the load should be distributed evenly. The maximum permitted drawbar load should be utilised. Do not place the load only at the front or the rear of the trailer:

☒ Distribute the load in the trailer so that heavy objects are either over or as near to the axle as possible.

☒ Secure all loads on the trailer properly.

Tyre pressure

Follow the trailer manufacturer's recommendations concerning the tyre pressure for the trailer tyres.

When towing a trailer, inflate the wheels on the towing vehicle with the maximum permitted tyre pressure ⇒ Tyre pressure .

WARNING

Accidents and serious injuries can occur if you exceed the vehicle's maximum permitted gross axle weight rating, drawbar load, gross vehicle weight rating or gross combination weight rating.

☒ Never exceed the specified values.

☒ Never let the actual weights at the front and rear axles exceed the gross axle weight ratings. Never exceed the permissible gross vehicle weight for the vehicle with weight at the front and rear of the vehicle.

WARNING

Loads that may slide can severely impair stability and driving safety, which can cause accidents and severe injuries.

☒ Always load trailers correctly.

☒ Always secure loads using suitable and undamaged lashing, retaining or securing straps.

Driving with a trailer

 First read and observe the introductory information and safety warnings ⇒  Introduction

Headlight adjustment

Towing a trailer can raise the front end of the vehicle enough for the dipped beam to dazzle other road users. Use the headlight range control to lower the light cone as required. Vehicles with dynamic headlight range control are adjusted automatically.

Things to note when driving with a trailer

☒ If the trailer has an overrun brake, apply the brakes gently at first and then firmly. This will prevent the jerking that can be caused by the trailer wheels locking.

☒ The combination weight causes the braking distance to increase.

☒ Select a lower gear prior to downhill gradients (manual gearbox or Tiptronic mode of the automatic gearbox) to additionally make use of engine braking. The brake system could otherwise overheat and fail.

☒ The vehicle's centre of gravity and therefore the vehicle's handling will change because of the trailer load and the increased combined towing weight of the vehicle and trailer.

☒ The weight distribution of a loaded trailer with an unladen towing vehicle is very unfavourable. When driving with this combination, drive particularly carefully and slowly.

Pulling off on slopes when towing a trailer

Depending on the steepness of the uphill gradient and the total weight of the trailer and vehicle, a vehicle towing a trailer could roll back a short distance when moving off on a hill.

When towing a trailer, pull off on slopes as follows:

☒ Depress and hold the brake pedal.

☒ Press button  once to switch off the electronic parking brake ⇒ Electronic parking brake .

☒ On vehicles with a manual gearbox, depress the clutch pedal fully.

☒ Select first gear ⇒ Manual gearbox: selecting a gear or selector lever position D/S ⇒ DSG® dual clutch gearbox .

☒ Pull on the  button and hold it in this position to hold the vehicle and trailer with the electronic parking brake.

☒ Release the brake pedal.

☒ Pull away slowly. To do this, slowly release the clutch pedal in the case of a manual gearbox.

☒ Release the  button only when the engine has sufficient power to move off.

WARNING

Incorrect trailer towing can cause loss of vehicle control and serious personal injury.

☒ Towing a trailer and transporting heavy or bulky items can change the way the vehicle handles and increase the braking distance.

☒ Always drive carefully and think ahead. Brake earlier than in normal driving.

☒ Always adapt your speed and driving style to suit visibility, weather, road and traffic conditions. Reduce your speed, particularly when going downhill.

☒ Accelerate very carefully and gently. Avoid abrupt and sudden driving and braking manoeuvres.

☒ Take special care when overtaking. Reduce your speed immediately if the trailer shows even the slightest sign of snaking.

☒ Never try to stop a trailer from snaking by increasing your speed.

☒ Observe the applicable speed limits. These may be lower for vehicles with trailers than for vehicles without trailers.

Trailer stabilisation





First read and observe the introductory information and safety warnings ⇒  Introduction

The trailer stabilisation function can detect if an attached trailer is starting to snake and can countersteer.

Trailer stabilisation is an extension of the Electronic Stability Control (ESC).

If trailer snaking is detected, the trailer stabilisation function automatically helps to reduce the snaking motion of the trailer using counter steering assistance.

Requirements for trailer stabilisation

- ☒ The towing bracket is either factory-fitted or a compatible towing bracket has been retrofitted.
- ☒ Electronic Stability Control (ESC) and traction control system (TCS) are active. The indicator lamp  or  in the instrument cluster is not lit up.
- ☒ The trailer is electrically connected to the towing vehicle via the trailer socket.
- ☒ The vehicle speed is higher than approximately 60 km/h (37 mph).
- ☒ The maximum drawbar load is used.
- ☒ The trailer must have a rigid drawbar.
- ☒ Trailers with brakes must have a mechanical overrun system.

WARNING

Do not let the extra safety afforded by the trailer stabilisation function tempt you into taking any risks when driving.

- ☒ Always adapt your speed and driving style to suit visibility, weather, road and traffic conditions.
- ☒ Accelerate carefully on slippery surfaces.
- ☒ Take your foot off the accelerator if one of the systems is taking corrective action.

WARNING

The trailer stabilisation function may not be able to detect all driving situations correctly.

- ☒ Trailer stabilisation is switched off when ESC is deactivated.
- ☒ Light trailers that are snaking will not be recognised by the trailer stabilisation function and stabilised accordingly in all cases.

- ☒ A trailer can still jack-knife on slippery roads with little grip even if the towing vehicle is equipped with trailer stabilisation.
- ☒ Trailers with a high centre of gravity might tip over before snaking starts.
- ☒ Sudden braking procedures can occur automatically in extreme driving situations if the trailer socket is being used without a trailer (e.g. for a bicycle carrier with lighting).

Retrofitting a towing bracket

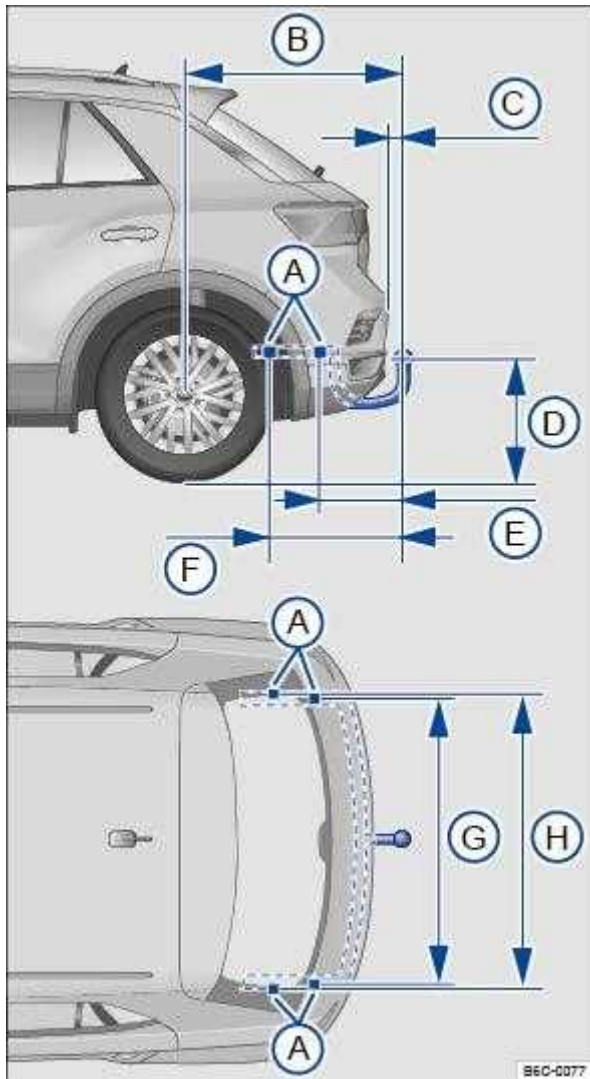

Fig. 157 Dimensions and mounting points for retrofitting a towing bracket.



First read and observe the introductory information and safety warnings ⇒ ⚠ Introduction

Volkswagen recommends having the towing bracket retrofitted by a qualified workshop. The cooling system may need to be modified or heat shields may need to be fitted. Volkswagen recommends using a Volkswagen dealership for this purpose.

Dimensions

The dimensions ⇒ Fig. 157 must be observed in all cases when retrofitting a towing bracket. Always observe the minimum distance given from the middle of the ball head (D) to the surface of the road. This also applies when the vehicle is fully laden, including maximum drawbar load.

☐ **A** Mounting points

☐ **B** 879 mm

☐ **C** at least 65 mm

☐ **D** 350 – 420 mm

☐ **E** 334 mm

☐ **F** 554 mm

☐ **G** 1,017 mm

☐ **H** 1,051 mm

 **WARNING**

Electrical cables that are not connected properly or are connected incorrectly can cause faults in the entire vehicle electronics system and also cause accidents and serious injuries.

☐ Never connect the trailer's electrical system directly to the electrical connections of the tail light clusters or to other unsuitable power sources. Use only suitable connectors for connection of the trailer.

☐ Have retrofitting of a towing bracket on the vehicle performed by a qualified workshop.

 **WARNING**

The trailer can become detached from the towing vehicle if the towing bracket is unsuitable or incorrectly fitted. This can cause serious accidents and fatal injuries.



Use only towing brackets which have been approved by Volkswagen for your vehicle type.

Fuel and emission control

Safety notes on handling fuel

 **WARNING**

Incorrect handling of fuel can cause explosions, fire, serious burns and other injuries.

☐ Switch off the engine, the auxiliary heater ⇒ Switching the auxiliary heater and ventilation on and off, the ignition, your mobile phone and other radio equipment before refuelling.

- ☒ Avoid electrostatic discharges by not entering the vehicle during refuelling.
- ☒ Make sure that the tank cap is closed properly and no fuel can escape.
- ☒ Observe the applicable safety instructions and local regulations on handling fuel.

 **WARNING**

Filling the tank with the wrong fuel can damage the vehicle.

- ☒ Use only fuels that have been approved for the vehicle.
- ☒ Do not use fuels that contain metals and use only Volkswagen-approved service additives in the approved quantity.
- ☒ Immediately remove any fuel that is spilled from all vehicle components.

 **CAUTION**

Fuel may run out of a fuel canister. This could cause fire and injuries.

- ☒ Do not carry a fuel canister in the vehicle.



Fuels can pollute the environment. Collect any service fluids that escape or are spilled and dispose of them correctly.



The tank flap cannot be opened manually. Seek expert assistance in an emergency.

Fuel types and refuelling

 Introduction

This chapter contains information on the following subjects:

- ⇒ Fuel standards
- ⇒ Petrol
- ⇒ Diesel
- ⇒ Refuelling

The tank flap is located at the rear right-hand side of the vehicle.

Different engines require different fuels. There is a factory-fitted sticker in the tank flap that indicates the required fuel type for the vehicle.

Information on warning and indicator lamps that light up can be found in the section Troubleshooting ⇒ Troubleshooting .

Fuel standards



First read and observe the introductory information and safety warnings ⇒ ⚠ Introduction

Petrol

📖 EN 228

📖 DIN 51626-1

Diesel

📖 EN 590

📖 DIN EN 590

Where fuel complying with the specified standard is not available, your Volkswagen dealership or a qualified workshop will have information on which available fuels are suitable for the vehicle.



NOTICE

Using fuel that does not comply with these standards may reduce performance and cause damage to the engine and fuel system.

- 📖 Before refuelling, check whether the fuel standard on the pump meets the vehicle's requirements.
- 📖 Use only fuels that meet the required standards in order to prevent damage to the fuel system and engine failure.

Petrol



First read and observe the introductory information and safety warnings ⇒ ⚠ Introduction

Fill vehicles with a petrol engine only with unleaded petrol or petrol with a maximum ethanol content of 10 % (E10) ⇒ ⚠ .

Fuel grades differ according to the octane number. The vehicle may be filled with petrol that has a higher octane number than the engine requires. However, this does not provide any advantage in terms of fuel consumption or engine output.

The fuel quality affects the running properties, performance and service life of the engine. Refuel with fuel that already contains suitable service additives ⇒ ⚠ .

Information on the fuel standards can be found in the chapter on fuel standards ⇒ Fuel standards .



NOTICE

Errors during refuelling or unsuitable fuel additives may cause damage to the vehicle.

☒ Before refuelling, check whether the fuel standard specified on the pump meets the vehicle's requirements.

☒ Use only Volkswagen-approved service additives in the approved quantity.

☒ Refuel only with petrol that has the specified Research Octane Number (RON) or higher. If, in an emergency, you have to use petrol with an octane number lower than the recommended number, drive at medium engine speeds and avoid high engine loading. Avoid high engine speeds and heavy engine loads. Refuel with petrol with the correct octane number as soon as possible.

Diesel



First read and observe the introductory information and safety warnings ⇒  Introduction

Fill vehicles with a diesel engine only with diesel or diesel with a maximum RME fuel content of 7 % ⇒ .

If you use diesel with a high sulphur content, the service intervals are shorter. Information on countries where the diesel has a high sulphur content is available from your Volkswagen dealership or a qualified workshop.

The fuel quality affects the running properties, performance and service life of the engine. Refuel with fuel that already contains suitable service additives ⇒ .

Information on the fuel standards can be found in the chapter on fuel standards ⇒ Fuel standards.

Winter-grade diesel fuel and filter preheater system

Winter-grade diesel fuel, which can be used at temperatures below -20°C (-4°F), is available during the cold months. In countries with different climates, diesel with a different temperature behaviour is offered. Information is available from your Volkswagen dealership, qualified workshops and filling stations in the respective country.

Diesel vehicles are equipped with a filter preheater system. When using winter-grade diesel fuel, the fuel system is safe for operation at temperatures down to around -24°C (-11°F). In order to ensure that the vehicle can also be started at low outside temperatures, Volkswagen recommends parking the vehicle in a location that is protected from the weather, e.g. in a garage ⇒ Troubleshooting.

Misfuelling prevention device

The tank filler neck in diesel vehicles may be fitted with a misfuelling prevention device. This is intended to help ensure that the vehicle is refuelled only using diesel filler nozzles.

If the nozzle cannot be inserted correctly into the tank filler neck, first check whether you are using a diesel filler nozzle. When you have made sure that you are using the correct filler nozzle, move the diesel filler nozzle to and fro slightly with light pressure. This can open the misfuelling prevention device and make it possible to refuel the vehicle. If the misfuelling prevention device still remains closed, go to a qualified workshop and have the system checked.

If it is necessary to refuel the vehicle using a fuel canister in the event of an emergency, the misfuelling prevention device will not open. In order to nevertheless fill the tank with fuel, pour the diesel into the tank extremely slowly in very small quantities.

⚠️ WARNING

Incorrect refuelling can lead to fire, serious injuries and vehicle damage.

- ❑ Before refuelling, check whether the fuel standard specified on the pump meets the vehicle's requirements.
- ❑ Do not refuel with pure RME fuel, petrol, fuel oil or other unsuitable fuels.
- ❑ Use only Volkswagen-approved service additives in the approved quantity.



At cold temperatures, louder noises may occur in the diesel engine and the exhaust gas may be tinged blue.

Refuelling



Fig. 158 Behind the tank flap: tank cap.



First read and observe the introductory information and safety warnings ⇒ ⚠️ Introduction

See the section on technical data for information on filling capacities ⇒ Fuel tank capacity .

Refuelling process

- ❑ Unlock the tank flap with the vehicle key or the  button in the driver door.
- ❑ Open the tank flap.
- ❑ Unscrew the tank cap and place it in the opening provided in the tank flap.
- ❑ The fuel tank is full when the properly operated automatic filler nozzle clicks off for the first time ⇒ ⚠️ .
- ❑ Screw the tank cap onto the tank filler neck.
- ❑ Close the tank flap.

⚠️ WARNING

Overfilling the fuel tank may cause the fuel to splash out and overflow. This can cause fires, explosions and serious injuries.

- ❑ Do not continue refuelling when the filler nozzle switches off for the first time.

Components relevant to emission control

Introduction

This chapter contains information on the following subjects:

⇒ Emission control with AdBlue

⇒ Refilling AdBlue

⇒ Catalytic converter

⇒ Particulate filter

⇒ Troubleshooting

🔍 AdBlue® ⇒ Emission control with AdBlue®

🔍 Catalytic converter ⇒ Catalytic converter

🔍 Particulate filter ⇒ Particulate filter

Information on warning and indicator lamps that light up can be found in the section Troubleshooting ⇒ Troubleshooting .

WARNING

Engine emissions contain carbon monoxide which can cause people to lose consciousness. It can also cause death.

- 🔍 Do not allow the engine to run in enclosed spaces.
- 🔍 Never start the engine in enclosed spaces.
- 🔍 Do not leave the vehicle unattended if the engine is running.

WARNING

The components of the exhaust system become very hot. This can cause fires.

- 🔍 Park the vehicle so that no part of the exhaust system can come into contact with any inflammable material underneath the vehicle, e.g. dry grass.
- 🔍 Do not apply additional underseal or anti-corrosion coatings to the exhaust pipes, catalytic converters, particulate filter or the heat shields.

Emission control with AdBlue®

First read and observe the introductory information and safety warnings ⇒ Introduction

The SCR catalytic converter uses AdBlue® urea solution to convert nitrogen oxides into nitrogen and water.

AdBlue® is a registered trademark and is also known as AUS32 or DEF (Diesel Exhaust Fluid).

The AdBlue® consumption figures depend on the driving style, operating temperature and ambient temperature. The remaining range and refill quantity can be checked on the instrument cluster display ⇒ Driving data display (multifunction display) .

The AdBlue® tank must never run empty ⇒  . As of a remaining range of approximately 2,400 km, the instrument cluster display will indicate that the AdBlue® must be refilled ⇒ Troubleshooting .

CAUTION

AdBlue® is an irritant and corrosive fluid that can damage the skin, eyes and respiratory organs upon contact.

- ☒ Always observe the instructions for use when using AdBlue®. If used in accordance with the instructions, it is not to be expected that a user will come into contact with AdBlue®.
- ☒ AdBlue® must be kept only in the closed original container. Never use empty food tins, bottles or other containers.
- ☒ Always store AdBlue® in a safe place out of reach of children.
- ☒ If AdBlue® gets into the eyes, immediately rinse your eyes with plenty of water for at least 15 minutes and consult a doctor.
- ☒ If AdBlue® comes into contact with the skin, immediately rinse your skin with plenty of water for at least 15 minutes and consult a doctor in the case of skin irritations.
- ☒ If AdBlue® is swallowed, immediately rinse the mouth out with plenty of water for at least 15 minutes. Do not induce vomiting unless instructed to do so by a doctor. Seek medical assistance immediately.

NOTICE

If the AdBlue® level is too low, the vehicle cannot be restarted after the ignition has been switched off. Starting with jump leads is also not possible.

- ☒ Refill a sufficient quantity of AdBlue® at the latest when the remaining distance reaches approximately 1,000 km.
- ☒ Never allow the AdBlue® tank to run empty.

NOTICE

Improper use of AdBlue® may cause damage to the vehicle that is not covered by the warranty.

- ☒ Only use AdBlue® that complies with the standard ISO 22241-1.
- ☒ Never add water, fuel or additives to the AdBlue®.

ⓘ Never fill AdBlue® in the diesel fuel tank.

ⓘ Do not permanently carry the refill bottle in the vehicle. The bottle may develop a leak following changes in temperature and damage and the AdBlue® may damage the vehicle interior.

Refilling AdBlue

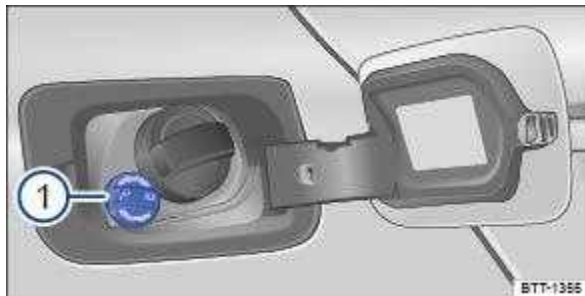

Fig. 159 Behind the tank flap: tank cap for AdBlue.

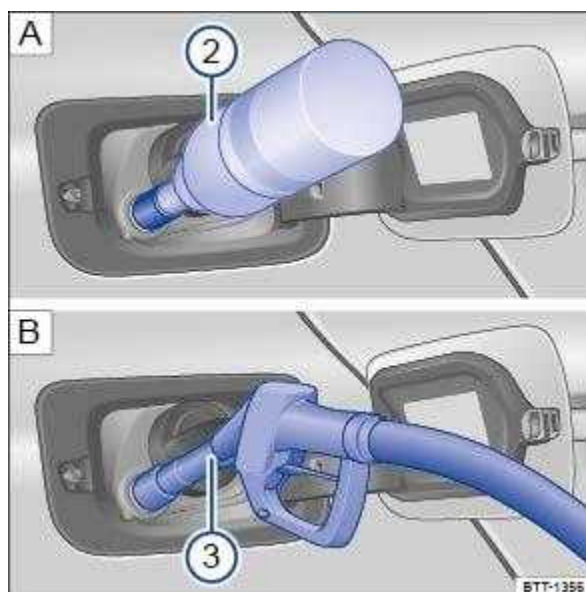



Fig. 160 Behind the tank flap: refilling AdBlue with the refill bottle or filler nozzle.

 First read and observe the introductory information and safety warnings ⇒  Introduction

Key to ⇒ Fig. 159 and ⇒ Fig. 160 :

ⓘ  Cap for the AdBlue® filler neck.

ⓘ  Refill bottle.

ⓘ  Filler nozzle.

Preparing to refill

ⓘ Park the vehicle on a level surface and switch off the ignition.

ⓘ Open the tank flap and unscrew the cap on the AdBlue® filler neck.

ⓘ Use only AdBlue® that complies with the standard ISO 22241-1.

Refilling AdBlue® with a refill bottle

- ☐ Unscrew the cap of the refill bottle.
- ☐ Place the refill bottle on the AdBlue® filler neck and screw the refill bottle tight.
- ☐ Keep pressing the refill bottle.
- ☐ The AdBlue® tank is full when AdBlue® no longer flows out of the refill bottle.
- ☐ Unscrew the refill bottle.

Refilling AdBlue® with a filler nozzle

The AdBlue® tank can be refilled at all AdBlue® pumps for passenger cars.

The filler nozzle may click off prematurely if filling is performed at a truck filling pump. There is a risk of AdBlue® spilling out due to the much higher filling speed.

- ☐ The AdBlue® filler nozzle works in the same way as a filler nozzle for fuel.
- ☐ The handle of the filler nozzle must point down during refilling in order to guarantee optimum filling.
- ☐ The AdBlue® tank is full as soon as the properly operated filler nozzle clicks off for the first time. Do not continue filling because the AdBlue® tank can be damaged by overfilling ⇒ .

Preparing to drive on

- ☐ Screw on the cap of the AdBlue® filler neck until it engages and then close the tank flap.
- ☐ Switch on only the ignition for at least 30 seconds so that refilling can be detected by the system.
- ☐ Start the engine only after this.

.

NOTICE

Overfilling AdBlue® may damage the tank system and the vehicle.

- ☐ Do not fill with more than the maximum refill quantity indicated on the instrument cluster display.
- ☐ Remove any spilled AdBlue® as quickly as possible with a damp cloth and plenty of cold water.
- ☐ Remove any crystallised AdBlue® with warm water and a sponge.



Dispose of the refill bottle in an environmentally friendly way.



Suitable AdBlue® refill bottles are available from a Volkswagen dealership.

Catalytic converter



First read and observe the introductory information and safety warnings ⇒ Introduction

☒ Refuel only with unleaded petrol ⇒ Petrol .

☒ Never run the fuel tank completely dry ⇒ Refuelling .

☒ Do not fill too much engine oil ⇒ Checking the engine oil level and refilling the engine oil .

☒ Never tow the vehicle to start it, but use jump leads instead ⇒ Jump starting the vehicle .

If you notice misfiring, loss of power or uneven running when driving, reduce speed immediately and have the vehicle checked by a qualified workshop ⇒ Troubleshooting . Otherwise unburnt fuel can enter the exhaust system and escape into the atmosphere. The catalytic converter can also be damaged by overheating.



The emissions may have a sulphur-like smell even when the exhaust purification system is working properly.

Particulate filter



First read and observe the introductory information and safety warnings ⇒ Introduction

Function

☒ Refuel only with fuels that are suitable for the vehicle ⇒ Fuel standards .

☒ Never run the fuel tank completely dry ⇒ Refuelling .

☒ Use only engine oil which is suitable for the vehicle and do not overfill oil ⇒ Engine oil standards .

☒ Never tow the vehicle to start it, but use jump leads instead ⇒ Jump starting the vehicle .

Periodic regeneration

The soot in the particulate filter is burnt off at high temperatures on a periodic basis.

To assist the regeneration of the particulate filter, Volkswagen recommends that you avoid making only short journeys.

Noises, slight smells and increased engine speeds may occur during regeneration. The radiator fan may run on while the vehicle is moving or when the engine has been switched off.



During the periodic regeneration process, the yellow indicator lamp does not light up.

Troubleshooting



First read and observe the introductory information and safety warnings ⇒ Introduction

Irregular engine running and faults

☒ Reduce speed immediately.

☒ Drive to nearest qualified workshop at medium engine speeds and with low engine loads.

☒ If these symptoms occur directly after refuelling, switch off the engine immediately to avoid any subsequent damage.

☒ Seek expert assistance.

 Fault in the selective catalytic reduction system

The red refill bottle lamp lights up together with the red spanner lamp.

The engine cannot be restarted.

☒ Drive immediately to a qualified workshop without switching off the engine.

☒ Have the system checked.

 AdBlue® level too low

The red refill bottle lamp lights up.

The engine cannot be restarted.

☒ Stop the vehicle.

☒ Refill the minimum AdBlue® filling quantity ⇒ Refilling AdBlue .

 Fault in the selective catalytic reduction system

The yellow refill bottle lamp lights up together with the yellow spanner lamp.

There is a fault in the selective catalytic reduction system or the system is not filled with standard-compliant AdBlue®.

☒ Drive to a qualified workshop immediately.

☒ Have the system checked.

 AdBlue® level low

The yellow refill bottle lamp lights up.

☒ Refill AdBlue® within the displayed remaining range in accordance with ⇒ Refilling AdBlue .

 Particulate filter clogged with soot

The yellow particulate filter lamp lights up.

The particulate filter is saturated with soot and requires regeneration. The indicator lamp goes out automatically when the particulate filter has been regenerated.

☒ Support regeneration by driving at speeds between 50–120 km/h (31–75 mph).

☒ Observe the relevant speed limits and the gear-change indicator ⇒ Gear-change indicator .

☒ If the indicator lamp is still lit up after driving for approx. 30 minutes, seek expert assistance immediately.

Fault in exhaust system

The yellow catalytic converter lamp lights up or flashes.

Faults in the exhaust system caused by misfiring, which can damage the catalytic converter.

☑ Drive to the nearest qualified workshop immediately.

☑ Have the engine and the exhaust system checked.



There may be engine faults and fuel consumption may be higher if the indicator lamps are lit up or flashing.

If and when

Vehicle toolkit



Introduction

This chapter contains information on the following subjects:

⇒ Stowage

⇒ Vehicle toolkit contents

Observe any country-specific legislation when securing your vehicle in the event of a breakdown.

Vehicle toolkit in the vehicle

In vehicles that are factory-fitted with a spare wheel, emergency spare wheel or winter wheels, additional vehicle tools may be located in the luggage compartment.



WARNING

In the event of a sudden driving or braking manoeuvre or accident, a loose vehicle toolkit, breakdown set and spare wheel or temporary spare wheel could be flung through the vehicle and cause severe injuries.

☑ Ensure that the vehicle toolkit, breakdown set and spare wheel or temporary spare wheel are always secured in the luggage compartment.



WARNING

Unsuitable or damaged tools in the vehicle toolkit can lead to accidents and injuries.

☑ Never work with unsuitable or damaged tools from the vehicle toolkit.

Stowage

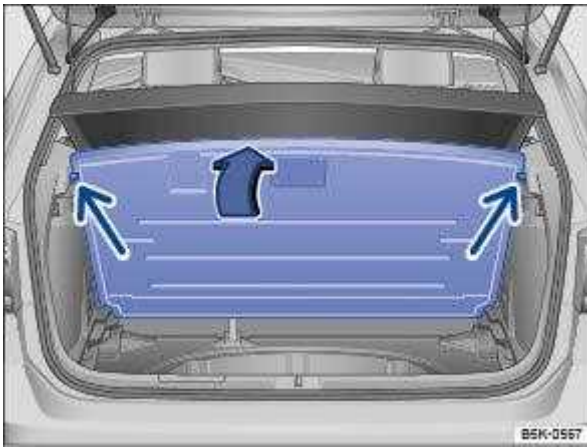

Fig. 161 In the luggage compartment: opening the luggage compartment floor.



First read and observe the introductory information and safety warnings ⇒ ⚠ Introduction

The vehicle toolkit may be located in various places in the vehicle, e.g. in the side storage area of the luggage compartment or under the luggage compartment floor ⇒ Fig. 161 .

☑ Remove the luggage net if necessary ⇒ Transporting items .

☑ Grip the recessed handle in the luggage compartment floor and lift it until it is held in position by the side restraints (arrows).



NOTICE

Never drop the luggage compartment floor; guide it slowly back down. The trims or the luggage compartment floor could otherwise be damaged.



After using the vehicle jack, crank it back to its original position so that it can be stowed safely.

Vehicle toolkit contents

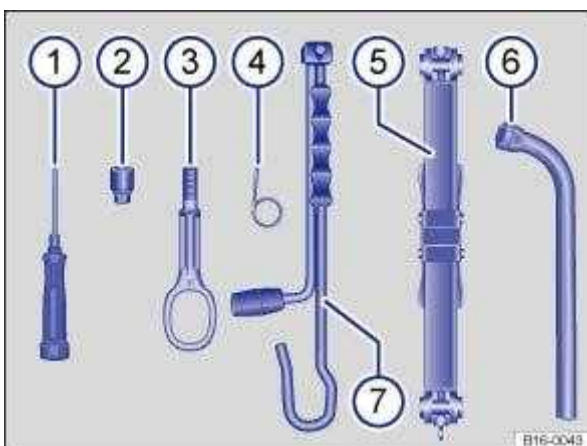

Fig. 162 Contents of the vehicle toolkit.



First read and observe the introductory information and safety warnings ⇒ ⚠ Introduction

The content of the vehicle toolkit varies according to the vehicle equipment level ⇒ Fig. 162 . The following describes the maximum scope.

Key to ⇒ Fig. 162 :

- ① Screwdriver with hexagon socket in the handle for unscrewing or tightening slackened wheel bolts. The screwdriver blade is reversible. The screwdriver may be stowed under the box spanner.
- ② Adapter for the anti-theft wheel bolt. Volkswagen recommends that you carry the wheel bolt adapter in the vehicle toolkit at all times. The code number of the anti-theft wheel bolt is engraved on the front of the adapter. You will need this number to replace the adapter if lost. Make a note of the code number for the anti-theft wheel bolt and keep it in a safe place – but not inside the vehicle.
- ③ Removable towing eye.
- ④ Wire hook for pulling off the centre wheel trims, wheel covers and the wheel bolt caps.
- ⑤ Vehicle jack. Before you repack the jack, you must fully wind in the claw.
- ⑥ Box spanner for wheel bolts.
- ⑦ Crank.

Vehicle jack: maintenance

There are no maintenance cycles for the vehicle jack. Grease it with universal lubricant when necessary.

Wiper blades

Service position

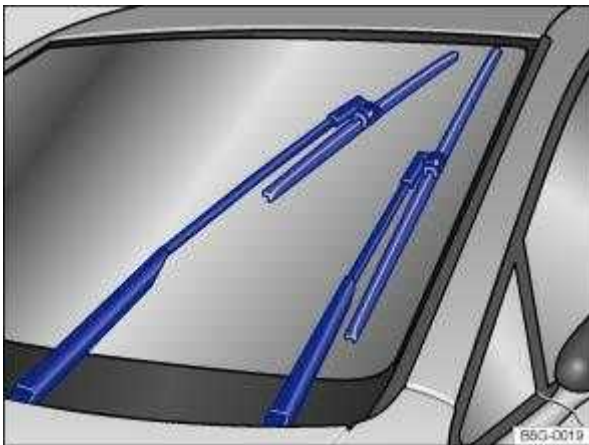

Fig. 163 Wiper blades in service position.

The windscreen wiper arms can be lifted off the windscreen when in the service position. Proceed as follows to move the wipers to the service position ⇒ Fig. 163 :

Activating service position

- ① The bonnet must be closed ⇒ In the engine compartment .

☒ Switch the ignition on and then off again.

☒ Push the wiper lever downwards briefly.

Lifting the windscreen wiper arms

☒ Move the wiper arms to the service position before lifting ⇒ ⚠ .

☒ When lifting a wiper arm, hold it only in the area of the wiper blade mounting.

Place the windscreen wiper arms back onto the windscreen before driving away. With the ignition switched on, briefly press the windscreen wiper lever down to bring the windscreen wiper arms back to the original position.

⚠ NOTICE

☒ In order to prevent damage to the bonnet and the windscreen wiper arms, the windscreen wiper arms should be lifted only when in the service position.

☒ Always return the windscreen wiper arms to the windscreen before starting your journey.

Cleaning and replacing wiper blades

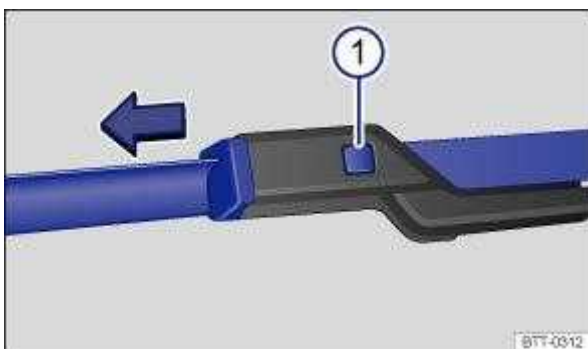

Fig. 164 Changing the windscreen wiper blades.

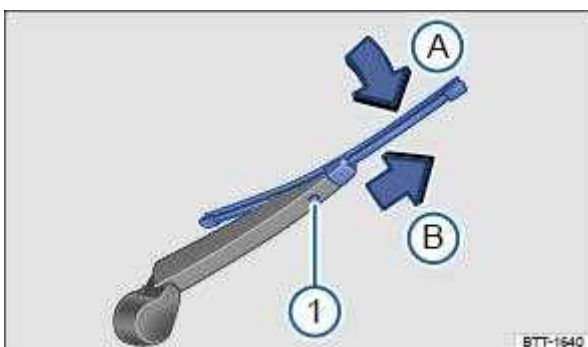

Fig. 165 Changing the rear wiper blade.

The factory-fitted wiper blades are coated with graphite. The graphite coating ensures that the wiper blade moves quietly over the window. If the graphite coating is damaged, the wiper will make a louder noise when wiping over the window.

Check the condition of the wiper blades on a regular basis. Rubbing wiper blades should be replaced if damaged or cleaned if dirty ⇒ ⚠ .

Damaged wiper blades should be replaced immediately. Wiper blades are available from a qualified workshop.

Cleaning wiper blades





Note for the front windscreen wipers: move the wiper arms to the service position before lifting them ⇒ Service position .

- ☒ When lifting a wiper arm, hold it only in the area of the wiper blade mounting.
- ☒ Clean the wiper blades carefully using a damp cloth ⇒ .
- ☒ Place the wiper arms carefully back onto the window.

Changing the windscreen wiper blades

- ☒ Move the wiper arms to the service position before lifting ⇒ Service position .
- ☒ When lifting a wiper arm, hold it only in the area of the wiper blade mounting.
- ☒ Press and hold the release button ⇒ Fig. 164  and simultaneously pull off the wiper blade in the direction of the arrow.
- ☒ Insert a new wiper blade with the same length and design onto the wiper arm. Push it on until it engages.
- ☒ Place the wiper arms carefully back onto the windscreen.

Changing the wiper blade for the rear window

- ☒ When lifting a wiper arm, hold it only in the area of the wiper blade mounting.
- ☒ Lift and fold back the wiper arm.
- ☒ Press and hold the release button ⇒ Fig. 165 .
- ☒ Tilt the wiper blade in the direction of the wiper arm ⇒ Fig. 165 (arrow ) and pull it off in the direction of the arrow  at the same time. You may need to use some force to do this.
- ☒ Insert a new wiper blade with the same length and design onto the wiper arm in the opposite direction of the arrow. Push it on until it engages ⇒ Fig. 165 . The wiper blade must be in the folded back position ⇒ Fig. 165 (arrow ).
- ☒ Carefully place the wiper arm back onto the rear window.

WARNING

Worn or dirty wiper blades reduce visibility and increase the risk of accidents and serious injuries.

- ☒ Always change wiper blades if they are damaged or worn and no longer clean the windows properly.

NOTICE

Damaged or dirty wiper blades can scratch the window glass.

☒ Do not use any cleaning agents containing solvents, hard sponges and other sharp objects, as they can damage the graphite coating of the wiper blades during cleaning.

☒ Do not use fuel, nail varnish remover, paint thinner or similar products to clean the windows.



Wax deposits from car washes on the windscreen and rear window can cause the wiper blades to rub. Remove wax residue using a special cleaning product or cleaning cloths.

Changing bulbs



Introduction

This chapter contains information on the following subjects:

⇒ Checklist

⇒ Changing bulbs in the front headlights (halogen bulbs)

⇒ Changing the bulbs in the headlights (lights with LED technology)

⇒ Changing the front turn signal bulbs

⇒ Changing bulbs in the front bumper

⇒ Changing bulbs in the tail light clusters (LED lights)

⇒ Changing bulbs in the number plate light (LED lights)

⇒ Troubleshooting

Changing the vehicle bulbs requires a certain amount of technical skill. Volkswagen therefore recommends having bulbs replaced by a qualified workshop if you are uncertain. The work must be performed by an expert if other vehicle parts around the affected bulbs need to be removed. Volkswagen recommends having bulbs replaced by a Volkswagen dealership.

You should keep a box with spare light bulbs for the lights that ensure the vehicle is roadworthy in the vehicle at all times. Spare bulbs are available from Volkswagen dealerships. In some countries it is a legal requirement to have these spare bulbs in the vehicle.

It may be illegal to drive with defective lights of the exterior lighting.

Information on indicator and warning lamps can be found in the troubleshooting section at the end of the chapter ⇒ Troubleshooting .

LED lights on the vehicle

The exterior lighting may feature LEDs: Owners cannot replace the LEDs themselves. If some LEDs fail, this may be an indication that more elements are on the point of failure. In this case, have the lights checked and replaced if necessary at a qualified workshop.

☒ Headlights

☒ Daytime running lights

☒ Turn signal repeaters

☒ Number plate light

☒ Tail light clusters

Additional bulb specifications

Some bulbs in headlights or in tail light clusters might have factory specifications that are different to standard bulbs. The designation is inscribed on the bulb, either on the glass part or on the base.

 WARNING

Accidents can occur if roads are not sufficiently illuminated and other road users have difficulty seeing the vehicle, or cannot see it at all.

 WARNING

Changing bulbs incorrectly can cause accidents and serious injuries.

☒ When working in the engine compartment, always read and observe the safety warnings ⇒ In the engine compartment . The engine compartment of any motor vehicle is a dangerous area. Serious injuries can be sustained here.

☒ H7 bulbs are pressurised and could explode when they are being changed.

☒ Change the defective bulb only once it has cooled down completely.

☒ Never change a bulb unless you are familiar with the procedure. If you are uncertain of what to do, the work should be carried out by a qualified workshop.

☒ Do not touch the glass part of the bulb with unprotected fingers. When the light is switched on, heat will cause fingerprints to evaporate on the bulb, which in turn will cause the reflector to go blind.

☒ There are sharp-edged parts in the headlight housing in the engine compartment and on the tail light cluster housing. Protect your hands when changing bulbs.

 NOTICE

Damage to the electrical system can be caused by water entering the system if the rubber cover or plastic covers on the headlight housing are not properly mounted after a bulb has been changed.

Checklist Information on changing bulbs



First read and observe the introductory information and safety warnings ⇒ Introduction

Checklist

Always carry out the following actions for changing a bulb in the given order ⇒ :



Park the vehicle on a firm and level surface at a safe distance from the flow of traffic.



Switch on the electronic parking brake Electronic parking brake.



Turn the light switch to position 0 Switching lights on and off.



Move the turn signal and main beam lever to neutral position Switching turn signals on and off.



Automatic gearbox: move the selector lever to position P DSG® dual clutch gearbox.



Stop the engine and remove the vehicle key from the ignition Starting the engine.



Manual gearbox: select a gear Manual gearbox: selecting a gear.



Allow the orientation lighting to go out Coming Home and Leaving Home function (orientation lighting).



Leave the defective bulbs to cool down.



Check to see if a fuse has visibly blown Changing fuses.



Follow the instructions to change the affected bulb . Always replace bulbs with identical bulbs of the same type. The designation is inscribed on the bulb, either on the glass part or on the base.



Do not touch the glass part of the bulb with unprotected fingers. When switched on, the heat of the bulb would cause the remaining fingerprint to evaporate and be deposited on the reflector. This will impair the light output of the headlight.



After changing a bulb, check to ensure that the bulb is working properly. If the bulb is not working properly, the bulb may not have been inserted properly, may have failed again, or the connector may have been fitted incorrectly.



Any time you change a bulb at the front of the vehicle, the headlight settings should be checked by a qualified workshop.

 **WARNING**

Ignoring any of the items on this important safety checklist can lead to accidents and severe injuries.

☑ Always follow the instructions in the checklist and observe the general safety procedures.

 **NOTICE**

Always take care when removing or fitting lights to prevent damage to the paintwork or to other vehicle parts.

Changing bulbs in the front headlights (halogen bulbs)

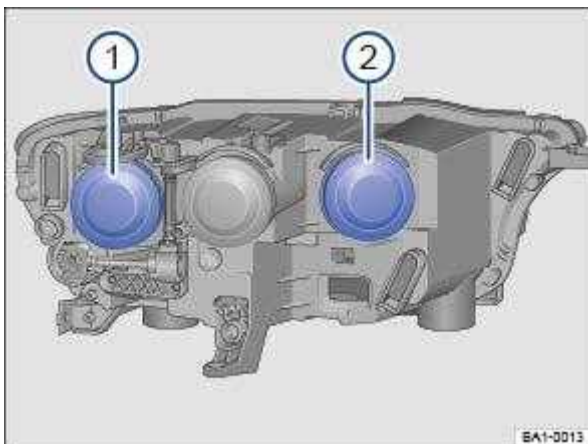

Fig. 166 In engine compartment: covers on the left-hand headlight: ① dipped beam, ② main beam.

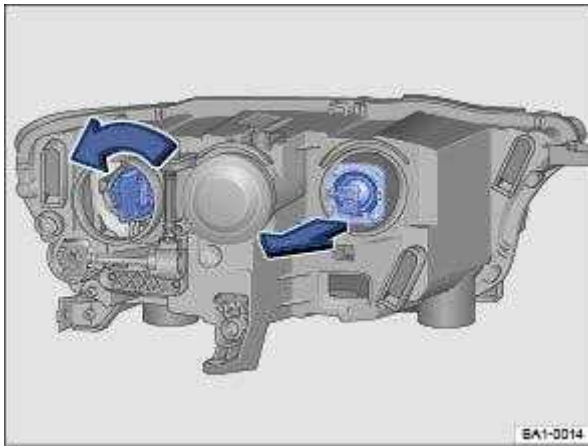

Fig. 167 In the engine compartment: changing bulbs in the left front headlight.



First read and observe the introductory information and safety warnings ⇒ ⚠ Introduction

The front headlight does not need to be removed when changing bulbs.

The actions should always be carried out in the specified order:

⇒ Fig. 166 and ⇒ Fig. 167

① Observe and follow the instructions on the checklist ⇒ Checklist Information on changing bulbs

② Open the bonnet ⚠ ⇒ In the engine compartment .

③

Pull off the rubber cover on the rear side of the headlight. Depending on the version, a hard plastic cover may be fitted here. Turn the cover anti-clockwise and remove it.

④

Dipped beam ① Turn the bulb holder anticlockwise as far as it will go and carefully pull it out to the rear along with the bulb.

Main beam ② Press on the bulb from below, as shown by the arrow, until it engages. Lift the bulb back and out.

⑤

Replace the defective bulb with a new bulb of the same type.

⑥

Dipped beam ① Insert the bulb holder into the headlight and turn it clockwise as far as it will go.

Main beam ② Insert the bulb into the opening in the headlight with the connector at the top and push down. The lug of the bulb must be located in the headlight recess (small arrow).

⑦

Attach the rubber cover or hard plastic cover and turn it clockwise as far as it will go.

⑧ Close the bonnet ⇒ In the engine compartment .

Changing the bulbs in the headlights (lights with LED technology)



First read and observe the introductory information and safety warnings ⇒ ⚠ Introduction

These lamps use LED technology. The LEDs cannot be replaced by customers. If some LEDs fail, this may be an indication that more elements are on the point of failure. In this case, have the lights checked and renewed if necessary at a qualified workshop.

Changing the front turn signal bulbs

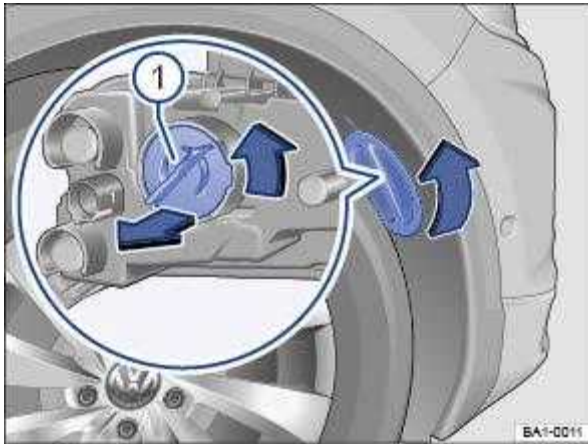

Fig. 168 In the front right wheel housing liner: changing a turn signal bulb.



First read and observe the introductory information and safety warnings ⇒ ⚠ Introduction

The actions should only be carried out in the specified order:

① Observe and follow the instructions in the checklist ⇒ Checklist Information on changing bulbs .

② Turn the steering so that the wheel on the affected side of the vehicle is pointing to the middle of the vehicle. If necessary, start the engine to do this. Then stop the engine again and remove the vehicle key from the ignition lock.

③ Turn the cover in the wheel housing liner in the direction of the arrow and remove it ⇒ Fig. 168 .

④ Release the connector ⇒ Fig. 168 ① and detach it.

⑤ Turn the bulb holder ⇒ Fig. 168 ② anti-clockwise (arrow) as far as it will go and pull it out to the rear along with the bulb.

⑥ Replace the defective bulb with a new bulb of the same type.

⑦ Insert the bulb holder into the headlight and turn it clockwise as far as it will go.

⑧ Fit the connector ⇒ Fig. 168 ① on the bulb holder ⇒ Fig. 168 ②. The connector should click into place.

⑨ Fit the cover in the wheel housing liner ⇒ Fig. 168 and lock it in position.

! NOTICE

Make sure that the electrical connection on the headlight housing is seated properly in order to prevent damage to the electrical system caused by water entering the system.

When removing and refitting the headlight, make sure that the vehicle's paintwork is not damaged.

Changing bulbs in the front bumper



Fig. 169 In the front bumper, right-hand side: removing the fog light.



First read and observe the introductory information and safety warnings ⇒ Introduction

The actions should only be carried out in the specified order:

① Observe and follow the instructions in the checklist ⇒ Checklist Information on changing bulbs .

② Take the wire hook from the toolkit and insert it in the opening in the cover ⇒ Fig. 169 . Pull the cover forwards in the direction of the arrow.

③ Use the screwdriver from the vehicle toolkit to unscrew the securing screws ⇒ Fig. 169 ① ⇒ Vehicle toolkit .

④ Pull the headlight out of the bumper towards the outside of the vehicle.

⑤ Release the connector and pull it off.

⑥ Turn the bulb holder anti-clockwise as far as it will go and pull it out to the rear along with the bulb.

- 7 Replace the defective bulb with a new bulb of the same type.
- 8 Insert the bulb holder into the headlight and turn it clockwise as far as it will go.
- 9 Connect the connector to the bulb holder. The connector must audibly click into place.
- 10 Push the headlight from the outside into the openings and insert into the bumper.
- 11 Use the screwdriver to tighten the securing screws ⇒ Fig. 169 ①.
- 12 Fit the cover in the bumper ⇒ Fig. 169 .
- 13 Stow the wire hook and screwdriver in the vehicle toolkit.

Changing bulbs in the tail light clusters (LED lights)



First read and observe the introductory information and safety warnings ⇒ ⚠ Introduction

These lamps use LED technology. The LEDs cannot be replaced by customers. If some LEDs fail, this may be an indication that more elements are on the point of failure. In this case, have the lights checked and renewed if necessary at a qualified workshop. Volkswagen recommends using a Volkswagen dealership for this purpose.

Changing bulbs in the number plate light (LED lights)



First read and observe the introductory information and safety warnings ⇒ ⚠ Introduction

These lamps use LED technology. The LEDs cannot be replaced by customers. If some LEDs fail, this may be an indication that more elements are on the point of failure. In this case, have the lights checked and renewed if necessary at a qualified workshop.

Troubleshooting



First read and observe the introductory information and safety warnings ⇒ ⚠ Introduction



Fault in vehicle lighting

The indicator lamp lights up yellow.

Fault in vehicle lighting or fault in cornering lights.

Check the vehicle lighting and change the appropriate bulb as required ⇒ Changing bulbs . If all bulbs are OK or there is a fault in the dynamic cornering light, go to a qualified workshop.

Changing fuses



Introduction

This chapter contains information on the following subjects:

⇒ Fuses in the dash panel

- ⇒ Fuses in the engine compartment
- ⇒ Fuse table for fuses in the dash panel
- ⇒ Fuse tables for fuses in the engine compartment
- ⇒ Changing a blown fuse

At the time of publication we are unable to provide an complete overview of the locations of the fuses for the electrical consumers. This is because the vehicle is under constant development, because fuses are assigned differently according to the vehicle equipment level and because several electrical consumers may use a single fuse. You can obtain more information about the fuse assignment from a Volkswagen dealership.

Several electrical consumers can share a single fuse. Conversely, a single consumer could have more than one fuse.

Therefore fuses should only be replaced when the cause of the fault has been rectified. If a new fuse blows shortly after fitting, have the electrical system checked by a qualified workshop.

 **WARNING**

High voltages in the electrical system can cause electric shocks, serious burns and death.

- ⓘ Never touch the electrical wiring of the ignition system.
- ⓘ Avoid causing short circuits in the electrical system.

 **WARNING**

Using unsuitable or repaired fuses and bridging an electrical circuit without fuses can cause a fire and serious injuries.

- ⓘ Never fit fuses that have a higher fuse protection limit. Fuses must always be replaced by a new fuse with the same amp rating (same colour and markings) and size.
- ⓘ Never repair a fuse.
- ⓘ Never use a metal strip, paper clip or similar objects to replace a fuse.

 **NOTICE**

- ⓘ To avoid damage to the electrical system in the vehicle, always switch the ignition, lights and all electrical consumers off and remove the vehicle key from the ignition before changing a fuse.
- ⓘ You can damage another location in the electrical system by using a fuse with a higher amp rating.
- ⓘ Fuse boxes must be protected from dirt and moisture when opened. Dirt and moisture in the fuse boxes can damage the electrical system.



There are other fuses in the vehicle in addition to those described in this chapter. These should be changed only by a qualified workshop.

Fuses in the dash panel

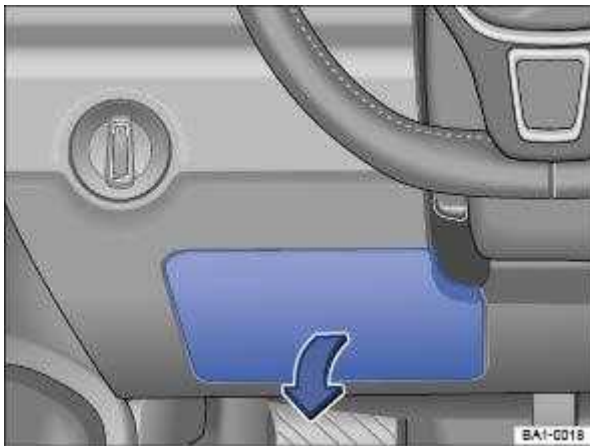

Fig. 170 Dash panel on the driver side: fuse box cover.

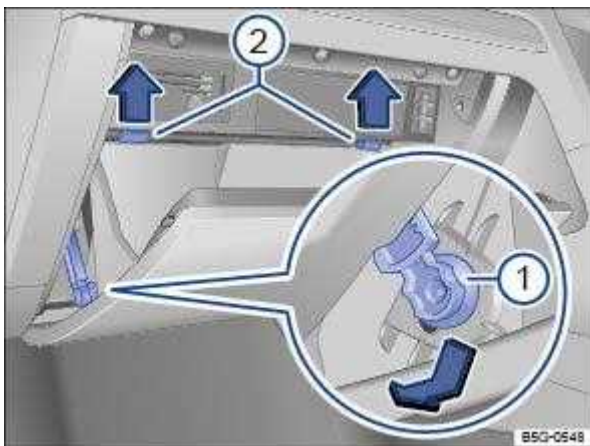

Fig. 171 Fuse box cover in the dash panel: right-hand drive vehicle, on the front passenger side.



First read and observe the introductory information and safety warnings ⇒ ⚠ Introduction

Left-hand drive: opening the fuse box in the dash panel

☐ Reach behind the cover ⇒ Fig. 170 and pull it forward.

Right-hand drive: opening the fuse box in the dash panel

☐ Open the stowage compartment on the front passenger side and remove the contents if necessary ⇒ Fig. 171 .

☐ Slide the braking element ⇒ Fig. 171 ① downwards into the opening in the holder and pull it out sideways.

☐ Push catches ⇒ Fig. 171 ② upwards in the direction of the arrow whilst opening the stowage compartment further.

☐ To install: move the stowage compartment into position. Insert brake element into the opening of the holder and push it upwards until it audibly clicks into place. Carefully push the stowage compartment forwards beyond the resistance of the catches ⇒ Fig. 171 ②.

ⓘ NOTICE

☐ Remove the covers of the fuse boxes carefully and install them again properly so as to avoid damage to the vehicle.

☐ Fuse boxes must be protected from dirt and moisture when opened. Dirt and moisture in the fuse boxes can damage the electrical system.

Fuses in the engine compartment

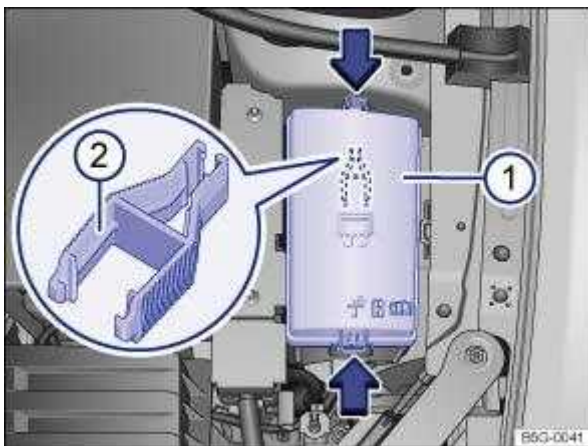

Fig. 172 In the engine compartment: cover ① of fuse box with plastic pliers ②.



First read and observe the introductory information and safety warnings ⇒ ⚠ Introduction

Opening the fuse box in the engine compartment

☐ Open the bonnet ⚠ ⇒ In the engine compartment .

☐ Press the release buttons in the direction of the arrow ⇒ Fig. 172 ① to release the fuse box cover.

☐ Lift off the cover.

☐ To install, position the cover on the fuse box and press it downwards until the cover audibly clicks into place on both sides.

In some vehicles, there is a pair of plastic pliers ⇒ Fig. 172 ② for removing fuses on the inside of the cover of the fuse box in the engine compartment.

ⓘ NOTICE

☐ Remove the covers of the fuse boxes carefully and install them again properly so as to avoid damage to the vehicle.

☒ Fuse boxes must be protected from dirt and moisture when opened. Dirt and moisture in the fuse boxes can damage the electrical system.

Fuse table for fuses in the dash panel

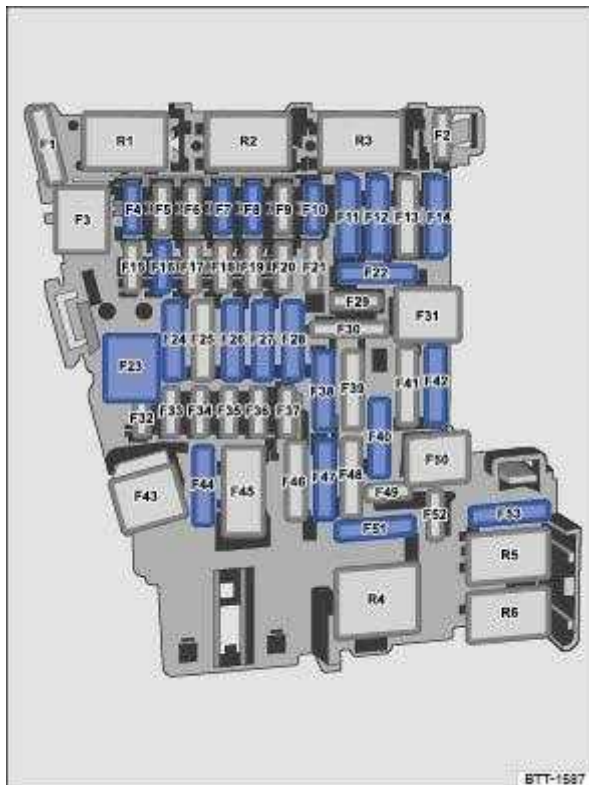

Fig. 173 In the dash panel: fuse assignment.



First read and observe the introductory information and safety warnings ⇒ ⚠ Introduction

The table shows the fuse locations of the electrical consumers relevant for the driver. The first column in the table contains the location. The other columns contain the fuse type, the amp rating and the consumer protected by the fuse.

Depending on the market and specification of your vehicle, the fuse numbers and positions may differ to those given in the table. If necessary, ask your Volkswagen dealership for the exact fuse assignment.

Fuse location ⇒ Fig. 173

F410 amps, MINI®, anti-theft alarm. F710 amps, MINI®, air conditioning system control panel or heating and fresh air system, rear window heating relay. F810 amps, MINI®, light switch (dipped beam), rain/light sensor, electronic parking brake. F107.5 amps, MINI®, display, Infotainment control panel. F1140 amps, ATO®, left exterior lighting. F1220 amps, ATO®, Infotainment components. F1440 amps, ATO®, blower regulator. F167.5 amps, MINI®, telephone. F2215 amps, ATO®, trailer charging cable. F2330 amps, JCASE®, electric glass roof. F2440 amps, ATO®, right exterior lighting. F2630 amps, ATO®, seat heating. F2730 amps, ATO®, interior lighting. F2825 amps, ATO®, left trailer control unit. F3825 amps, ATO®, right trailer control unit. F401)20 amps, ATO®, cigarette lighter, sockets. F4240 amps, ATO®, central locking. F4415 amps, ATO®, trailer control unit. F4715 amps, ATO®, rear window wiper. F5125 amps, ATO®, rear seat heating. F5330 amps, ATO®, rear window heating.

1) Note installation position. Factory-fitted fuse location as shown in illustration ⇒ Fig. 173 .

Fuse tables for fuses in the engine compartment



First read and observe the introductory information and safety warnings ⇒ ⚠ Introduction

The table shows the fuse locations of the electrical consumers relevant for the driver. The first column in the table contains the location. The other columns contain the fuse type, the amp rating and the consumer protected by the fuse.

Depending on the market and specification of your vehicle, the fuse numbers and positions may differ to those given in the table. If necessary, ask your Volkswagen dealership for the exact fuse assignment.

F65 amps, ATO®, brake light sensor. F1440 amps, JCASE®, windscreen heating. F1515 amps, ATO®, horn. F1930 amps, ATO®, front wipers. F3720 amps, ATO®, auxiliary heater.

Changing a blown fuse

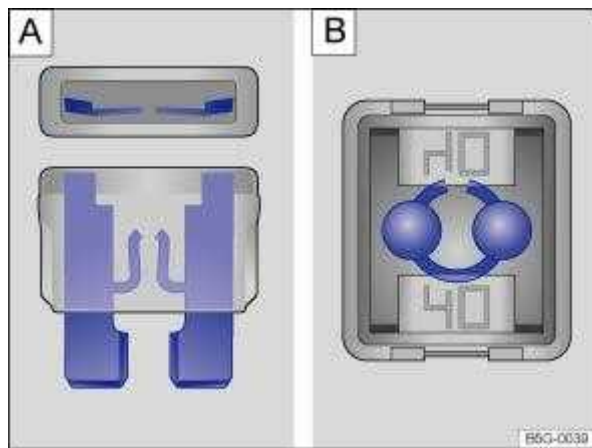

Fig. 174 Blown fuse: flat blade fuse, JCASE® fuse.

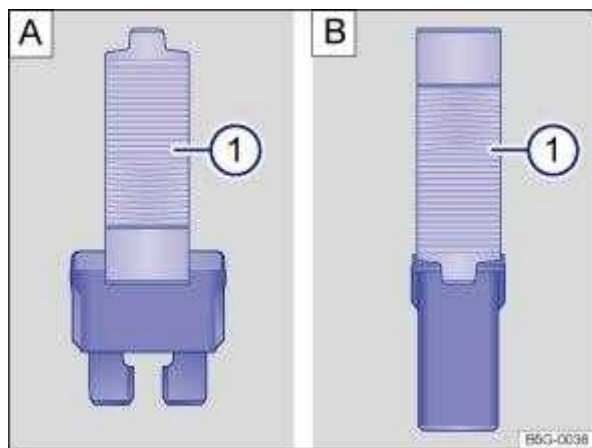

Fig. 175 Removing or inserting a fuse with plastic pliers: : flat blade fuse, : JCASE® fuse.



First read and observe the introductory information and safety warnings ⇒ ⚠ Introduction

Fuse types

☑ Standard flat blade fuse (ATO®).

☒ Small flat blade fuse (MINI®).

☒ JCASE® fuse.

Colour coding of fuses

Fuses (ATO / MINI / MAXI)

ColourAmp

ratingBlack1 ampsPurple3 ampsOrange5 ampsBrown7.5 ampsRed10 ampsBlue15 ampsYellow20 ampsWhite or clear25 ampsGreen30 ampsLight green40 amps

Fuses (JCASE)

Blue20 ampsPink30 ampsGreen40 ampsRed50 ampsYellow60 amps

Preparations

☒ Switch off the ignition, lights and all electrical equipment.

☒ Open the appropriate fuse box ⇒ Fuses in the dash panel .

Recognising a blown fuse

☒ Shine a torch onto the fuse. This will help you to spot a blown fuse more easily.

☒ If a flat blade fuse (ATO®, MINI®) has blown, this can be recognised from the top and side through the transparent housing due to the melted metal strip ⇒ Fig. 174 **A**.

☒ If a JCASE® fuse has blown, the melted metal strip can be recognised from the top through the transparent housing ⇒ Fig. 174 **B**.

Changing a fuse

☒ If necessary, take the plastic pliers ⇒ Fig. 175 **1** out of the respective fuse box cover.

☒ Push the plastic pliers clamp suitable for the fuse type ⇒ Fig. 175 **A** **1** or ⇒ Fig. 175 **B** **1** onto the fuse from the side.

☒ Pull out the fuse.

☒ If the fuse has blown, replace it with a new fuse of the same amp rating (same colour and same markings) and same size ⇒ **!** .

☒ Once the new fuse has been inserted, put the plastic pliers back in the cover if necessary.

☒ Insert the cover again or close the fuse box cover.

! NOTICE

You can damage another location in the electrical system by using a fuse with a higher amp rating.

Jump starting



Introduction

This chapter contains information on the following subjects:

⇒ Jump lead connection point (earth connection)

⇒ Jump starting the vehicle

If the engine fails to start because the 12-volt vehicle battery is flat, the discharged battery can be connected to the 12-volt battery of another vehicle to start the engine.

Suitable jump leads are needed for jump starting.

☒ At least 25 mm² for vehicles with petrol engines.

☒ At least 35 mm² for vehicles with diesel engines.



WARNING

Using the jump leads incorrectly or performing the jump start procedure incorrectly can cause the 12-volt vehicle battery to explode, which can lead to severe injuries. Please note the following in order to reduce the risk of the 12-volt vehicle battery exploding:

☒ All work on the 12-volt vehicle battery and the electrical system can cause serious chemical burns, fire or electric shocks. Always read the warnings and safety information before carrying out any kind of work on the 12-volt vehicle battery ⇒ 12-volt vehicle battery .

☒ The vehicle battery providing assistance must have the same voltage (12 volts) and approximately the same capacity (see label on battery) as the flat 12-volt vehicle battery.

☒ Never charge a frozen or thawed 12-volt vehicle battery. Discharged 12-volt vehicle batteries can already freeze at temperatures of around 0°C (+32°F).

☒ The 12-volt vehicle battery should be replaced if it is or has ever been frozen.

☒ A highly explosive mixture of gases is given off when the 12-volt vehicle battery is jump started. Always keep fire, sparks, naked flames and lit cigarettes away from the 12-volt vehicle battery. Never use a mobile telephone when the jump leads are being connected or disconnected.

☒ Position the jump leads so that they never come into contact with any moving parts in the engine compartment.

☒ Never confuse the negative and positive terminals or connect the jump leads incorrectly.

☒ Observe the jump lead manufacturer's instructions.



NOTICE

Please note the following in order to avoid considerable damage to the vehicle electrical system:

☒ A short circuit can be caused if the jump leads are wrongly connected.

ⓘ The vehicles must not touch each other, as any contact could mean that electricity could flow as soon as the positive terminals are connected.

Jump lead connection point (earth connection)



Fig. 176 In the engine compartment: jump lead connection point (earth connection).



First read and observe the introductory information and safety warnings ⇒ ⚠ Introduction

There is a jump lead connection point (earth connection) in the engine compartment for connecting the black jump lead ⇒ Fig. 176 ⊖.

The vehicle must be jump-started or used to jump-start another vehicle only via this jump lead connection point.

Jump starting the vehicle

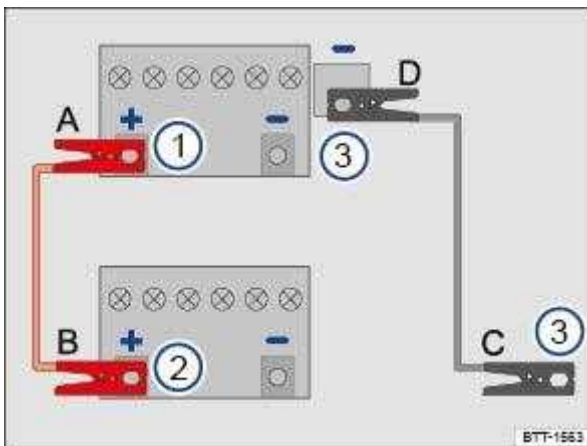

Fig. 177 How to connect the jump leads.



First read and observe the introductory information and safety warnings ⇒ ⚠ Introduction

Key to ⇒ Fig. 177 :

ⓘ ① Vehicle with discharged 12-volt vehicle battery that is being jump-started.

ⓘ ② Vehicle with 12-volt vehicle battery that is supplying power and jump-starting the other vehicle.

☐ ③ Suitable earth connection: preferably the jump lead connection point (earth connection), a solid metal part which is securely bolted onto the cylinder block, or the cylinder block itself.

The discharged 12-volt vehicle battery must be properly connected to the vehicle's electrical system.

The vehicles must not touch. Otherwise electricity could flow as soon as the positive terminals are connected.

Ensure that the battery clamps have good metal-to-metal contact with the battery terminals.

If the engine does not start immediately, switch off the starter after about 10 seconds and try again after about a minute.

If the engine still does not start, seek expert assistance.

Attaching the jump leads

The jump leads should be connected only in the order A – B – C – D ⇒ Fig. 177 .

The black jump lead should never be connected to the negative terminal (–) on the 12-volt vehicle battery. Connecting the lead to the negative terminal can cause incorrect condition evaluation of the 12-volt vehicle battery in the vehicle electronics.

☐ Switch off the ignition in both vehicles ⇒ Starting the engine .

☐ Open the cover on the 12-volt vehicle battery in the engine compartment, if a cover is installed ⇒ 12-volt vehicle battery .

☐ Connect one end of the red jump lead to the positive terminal (+) of the vehicle battery with the discharged 12-volt vehicle battery ⇒ Fig. 177 ① ⇒ ⚠ .

☐ Connect the other end of the red jump lead to the positive terminal (+) of the vehicle battery providing assistance ⇒ Fig. 177 ②.

☐ Connect one end of the black jump lead ⇒ Fig. 177 ③ preferably to a suitable jump start connection point (earth connection) or otherwise to a solid metal part that is securely bolted onto the cylinder block, or to the cylinder block itself of the vehicle providing assistance.

☐ On the vehicle with the flat 12-volt battery, connect the other end of the black jump lead ⇒ Fig. 177 ③ preferably to the jump lead connection point (earth connection), or otherwise to a solid metal part that is securely bolted onto the cylinder block, or to the cylinder block itself ⇒ ⚠ .

☐ Position the leads in such a way that they cannot come into contact with any moving parts in the engine compartment.

Starting the engine

☐ Start the engine of the vehicle providing assistance and let it run at idle.

☐ Start the engine of the vehicle with the discharged 12-volt vehicle battery and wait two or three minutes until the engine is running smoothly.

Removing the jump leads

☒ Before disconnecting the jump leads, switch off the dipped beam headlights if they are switched on.

☒ When the engine is running, the jump leads should be removed only in the order D – C – B – A ⇒ Fig. 177 .

☒ Go to a qualified workshop and have the 12-volt vehicle battery checked.

 **WARNING**

Jump starting the vehicle incorrectly can cause the 12-volt vehicle battery to explode, which can lead to serious injuries. Please note the following in order to reduce the risk of the 12-volt vehicle battery exploding:

☒ All work on the 12-volt vehicle battery and the electrical system can cause serious chemical burns, fire or electric shocks. Always read the warnings and safety information before carrying out any kind of work on the 12-volt vehicle battery ⇒ 12-volt vehicle battery .

☒ Always wear suitable eye protection and protective gloves, and never lean over the 12-volt vehicle battery.

☒ Attach the leads in the correct order – the positive lead first, followed by the negative.

☒ Never connect the negative lead to parts of the fuel system or to the brake lines.

☒ The non-insulated parts of the battery clamps must not be allowed to touch. The jump lead attached to the positive terminal on the 12-volt vehicle battery must not touch electrically conductive parts of the vehicle.

☒ Check the battery window on the 12-volt vehicle battery, using a torch if necessary. If it is light yellow or colourless, do not jump start the vehicle. Seek expert assistance.

☒ Avoid electrostatic discharge in the vicinity of the 12-volt vehicle battery. The hydrogen gas emitted from the 12-volt vehicle battery could be ignited by sparks.

☒ Do not perform jump starting if the 12-volt vehicle battery is damaged or if it is or has ever been frozen.

 **NOTICE**

Once the vehicle has been successfully jump-started, go to a qualified workshop and have the 12-volt vehicle battery checked.

Tow-starting or towing

 **Introduction**

This chapter contains information on the followingsubjects:

⇒ Notes on tow-starting and towing

⇒ Tow-starting

⇒ Towing

⇒ Fitting the rear towing eye

⇒ Fitting the front towing eye

Towing requires some experience, especially when using a tow rope. Both drivers should be familiar with the technique required for towing. Inexperienced drivers should not attempt to tow.

Ensure that no excessive pulling forces occur and take care to avoid jerking movements. When towing offroad, there is always a risk of overloading the anchorage points.

Observe any legal requirements when towing or tow-starting.

Tow-starting

Tow-starting describes the procedure for starting the vehicle by moving it using another towing vehicle.

The vehicle can be tow-started with a tow-bar or a tow-rope.

Towing

Towing is where a vehicle that cannot be driven is pulled with the aid of another vehicle.

The vehicle can be towed with a tow-bar or a tow-rope. When the engine is stopped, the gearbox is not lubricated sufficiently at higher speeds and over long distances:

☒ The maximum permitted towing speed is 50 km/h (30 mph).

☒ The maximum permitted towing distance is 50 km.

Tow rope, tow bar

It is easier and safer to tow a vehicle with a tow bar. Use a tow rope only if you do not have a tow bar.

The tow rope should be slightly elastic to reduce the strain on both vehicles. It is advisable to use a tow rope made of synthetic fibre or similarly elastic material.

Towing with a tow truck

If your vehicle is to be raised on one axle for towing, this may only be done using the following axles according to the gearbox/drive combination:

Front-wheel drive

Manual gearbox Front or rear axle Automatic gearbox Front axle



If a vehicle is being towed, the vehicle handling and braking efficiency will change significantly.

 WARNING

Never tow a vehicle that has no power supply.

☒ If the power supply in the vehicle fails during towing, stop towing immediately and seek expert assistance.

 NOTICE

When pushing the vehicle by hand, do not press on the tail light clusters, the side spoilers on the rear window, the rear spoiler or large panels. This could damage the vehicle and the rear spoiler could become detached.

 NOTICE

Remove and install the cover and the towing eye carefully so as to avoid damage to the vehicle, e.g. the paintwork.

Notes on tow-starting and towing



First read and observe the introductory information and safety warnings ⇒  Introduction

It is still possible to activate the turn signals in a vehicle that is being towed, even if the hazard warning lights are switched on. To do this, operate the turn signal lever in the required direction while the ignition is switched on. The hazard warning lights will not flash while the turn signal is being used. The hazard warning lights will start flashing again automatically as soon as the turn signal lever is moved back to the neutral position.

When should your vehicle not be tow-started or towed?

☒ The vehicle gearbox is damaged or does not contain any lubricant.

☒ The distance to be towed is further than 50 km.

☒ If the steering function or the operating clearance of the wheels cannot be ensured after an accident.

If the vehicle cannot be towed on its own four wheels due to one of the above conditions, seek expert assistance and have the vehicle transported on a recovery vehicle if necessary.

Tow-starting



First read and observe the introductory information and safety warnings ⇒  Introduction

Preparations for tow-starting

Vehicles with an automatic gearbox:

For technical reasons, your vehicle must not be tow-started. Attempt to start the engine by jump starting ⇒ Jump starting .

Vehicles with a manual gearbox:

Tow-starting is generally not recommended. If the engine does not start, first attempt to start the engine by jump starting ⇒ Jump starting . Please note that the maximum tow-starting distance for petrol engines is 50 m.

☒ Attach the tow-rope or the tow-bar only to the towing eyes provided ⇒ Fitting the rear towing eye or ⇒ Fitting the front towing eye .

☒ Switch on the ignition and the hazard warning lights.

☒ Select second or third gear while the vehicle is stationary.

☒ Press and hold the clutch pedal.

☒ Once both vehicles are moving, release the clutch pedal.

☒ As soon as the engine starts, press the clutch pedal and put the gear into neutral to prevent driving into the towing vehicle.

NOTICE

When tow-starting, unburnt fuel can enter the catalytic converter and damage it.

Towing



First read and observe the introductory information and safety warnings ⇒  Introduction

Preparations

☒ Attach the tow-rope or the tow-bar only to the towing eyes provided ⇒ Fitting the rear towing eye or ⇒ Fitting the front towing eye or to the towing bracket ⇒ Trailer towing .

☒ Make sure that the tow-rope is not twisted. Otherwise a towing eye may become unscrewed during towing.

☒ Switch on the ignition and hazard warning lights on both vehicles. However, observe any regulations to the contrary.

☒ Observe the instructions for towing in the vehicle wallet of the other vehicle.

Pulling vehicle (front)

☒ The tow-rope must be taut before you drive off properly.

☒ Accelerate with particular care.

☒ Avoid sudden braking and driving manoeuvres.

Vehicles with a manual gearbox:

☒ Engage the clutch particularly gently when driving off.

Pulled vehicle (rear)

☒ Ensure that the ignition is switched on so that the steering wheel is not locked and so that you can indicate, sound the horn and operate the wipers if necessary.

☒ The brake servo works only when the engine is running. The power steering works only when the ignition is switched on and the vehicle is rolling. Otherwise you must press the brake pedal with significantly more force and also use more effort for steering.

☒ Release the parking brake.

☒ Ensure that the tow-rope is always taut.

☒ Put the gearbox in neutral or select the selector lever position N.

Fitting the rear towing eye

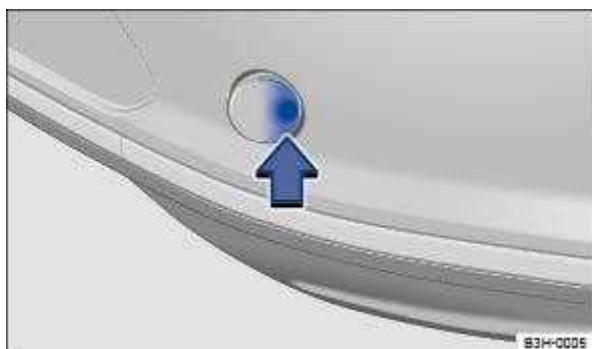

Fig. 178 On the right-hand side of the rear bumper: removing the cover.

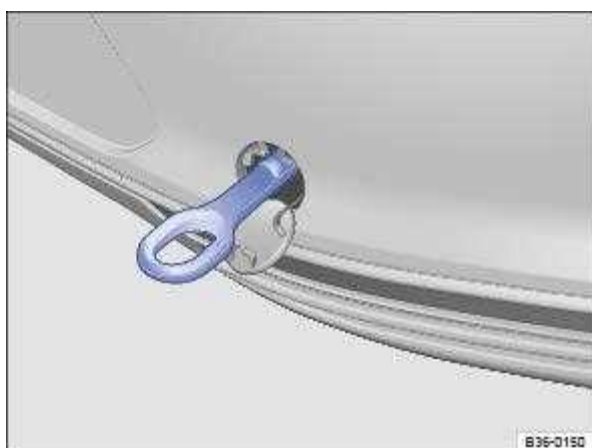

Fig. 179 On the right-hand side of the rear bumper: screwed-in towing eye.



First read and observe the introductory information and safety warnings ⇒ ⚠ Introduction

The towing eye must always be kept in the vehicle.

In vehicles with a factory-fitted towing bracket, there is no mounting for the screw-in towing eye behind the cover. To tow, swivel out or fit and use the ball head ⇒ Trailer towing .

Comply with the notes on towing ⇒ Notes on tow-starting and towing .

Fitting the rear towing eye

- ☐ Remove the towing eye from the vehicle toolkit in the luggage compartment ⇒ Vehicle toolkit .
- ☐ Push the lower area of the cover ⇒ Fig. 178 in the direction of the arrow to release the cover.
- ☐ Remove the cover and leave it hanging from the vehicle.
- ☐ Turn the towing eye clockwise into the mounting ⇒ Fig. 179 and tighten as far as it will go ⇒  . Use a suitable object to screw the towing eye fully and securely into the mounting.
- ☐ After you have finished towing, remove the towing eye by unscrewing it with a suitable object clockwise.
- ☐ After you have finished towing, remove the towing eye by unscrewing it anti-clockwise.
- ☐ Insert the cap in the respective recess and press in until it engages.
- ☐ Clean the towing eye if necessary and place it back in the vehicle toolkit in the luggage compartment.

NOTICE

- ☐ The towing eye must always be screwed fully and securely into the mounting. Otherwise, the towing eye can be torn out of the mounting when the vehicle is being tow-started or towed.
- ☐ Vehicles with a factory-fitted towing bracket must be towed only using tow bars that are specially designed for fitting to a ball coupling. If you use an unsuitable tow bar, the ball coupling and the vehicle could be damaged. You should use a tow rope instead.

Fitting the front towing eye

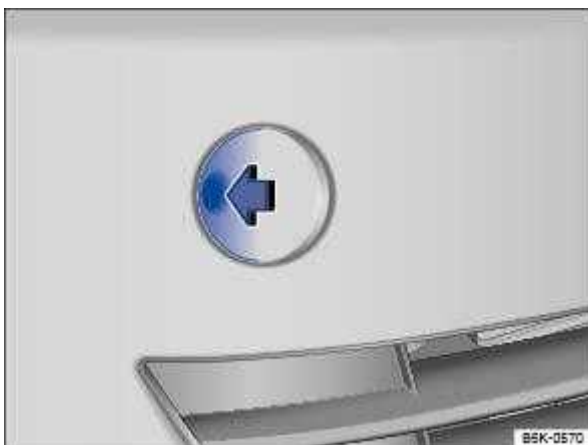

Fig. 180 In the front bumper on the right: removing the cover.

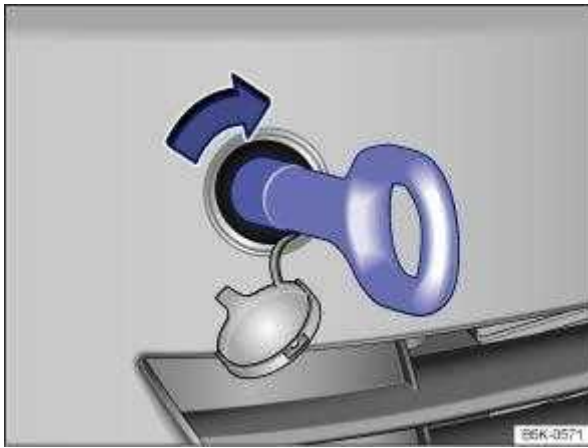

Fig. 181 In the front bumper on the right: screwing in the towing eye.



First read and observe the introductory information and safety warnings ⇒ ⚠ Introduction

The towing eye must always be kept in the vehicle.

The towing eye is screwed into a mounting behind a cover on the right of the front bumper ⇒ Fig. 180 .

Comply with the notes on towing ⇒ Notes on tow-starting and towing .

Fitting the front towing eye

☑ Remove the towing eye from the vehicle toolkit in the luggage compartment ⇒ Vehicle toolkit .

☑ Press at the side of the cover ⇒ Fig. 180 (arrow) to release the cover.

☑ Press in the left area of the cover ⇒ Fig. 180 (arrow) to release the cover.

☑ Pull the cover forwards to remove it and leave it to hang from the vehicle.

☑ Turn the towing eye clockwise into the mounting ⇒ Fig. 181 and tighten as far as it will go ⇒ ⚠ .
Use a suitable object to screw the towing eye fully and securely into the mounting.

☑ After you have finished towing, remove the towing eye by unscrewing it anti-clockwise.

☑ Insert the cap in the respective recess and press in until it engages.

☑ Clean the towing eye if necessary and place it back in the vehicle toolkit in the luggage compartment.



NOTICE

The towing eye must always be screwed fully and securely into the mounting. Otherwise, the towing eye can be torn out of the mounting when the vehicle is being tow-started or towed.

Checking and refilling

In the engine compartment

Safety notes for working in the engine compartment

The engine compartment of a motor vehicle is a hazardous area. Do not work on the engine and in the engine compartment unless you are familiar with the task, aware of the general safety procedures and have the correct equipment, service fluids and suitable tools. Serious injuries can be caused by carrying out work incorrectly ⇒ ⚠️. The work should be carried out by a qualified workshop if you are uncertain. Volkswagen recommends using a Volkswagen dealership for this purpose.

Always park the vehicle on a level and stable surface before carrying out any work in the engine compartment.

 **WARNING**

Unintentional vehicle movements during service work can cause serious injury.

ⓘ Never work underneath a vehicle if it is not secured against rolling away. If you are working underneath the vehicle while the wheels are on the ground, the vehicle must be on a level surface, the wheels chocked, and the vehicle key removed from the ignition lock as required.

ⓘ If you have to work underneath the vehicle, use suitable stands to provide extra support for the vehicle. The vehicle jack is not sufficient for this task and can fail, which can lead to serious injuries.

ⓘ The start/stop system must have been deactivated.

 **WARNING**

The engine compartment of any motor vehicle is a dangerous area. Serious injuries can be sustained here.

ⓘ The utmost care and attention must be paid when carrying out any work and you must follow the general safety rules. Never take any risks.

ⓘ Never do any work on the engine or in the engine compartment unless you know exactly how to carry it out. If you are uncertain of what to do, the work should be carried out by a qualified workshop. Serious injuries can result from work that has not been carried out properly.

ⓘ Never open the bonnet if you see steam or coolant escaping from the engine compartment. Hot steam or hot coolant can cause serious burns. Always wait until you can no longer see or hear steam or coolant coming from the engine compartment.

ⓘ Always allow the engine to cool down before opening the bonnet.

ⓘ Hot parts of the engine or exhaust system can burn the skin.

ⓘ Observe the following before opening the bonnet once the engine has cooled down:

ⓘ Switch on the electronic parking brake and move the selector lever to position P or move the gear lever to the neutral position.

ⓘ Switch off the ignition and remove the vehicle key from the ignition lock.

- ⓘ Always keep children away from the engine compartment and never leave the vehicle unattended.
- ⓘ The cooling system is under pressure when the engine is hot. Never open the cap of the coolant expansion tank when the engine is hot. Coolant may spray out and cause serious burns and other injuries.
- ⓘ Turn the cap on the coolant expansion tank slowly and very carefully anti-clockwise while exerting gentle downward pressure on the cap.
- ⓘ Always protect the face, hands and arms from hot coolant or steam with a large, thick cloth.
- ⓘ When refilling, do not spill any service fluids on engine components or on the exhaust system. The spilt service fluids can start a fire.

 **WARNING**

High voltages in the electrical system can cause electric shocks, burns, serious injuries and death!

- ⓘ Never short circuit the electric system. The 12-volt battery could explode.
- ⓘ To reduce the risk of an electric shock and serious injury while the engine is running or being started, never touch the electrical cables in the ignition system.

 **WARNING**

There are rotating components in the engine compartment that can cause serious injury.

- ⓘ Never place your hand near these components or into the area of the radiator fan. Touching the rotor blades can result in serious injuries. The fan is temperature-controlled and can start automatically, even when the ignition has been switched off or the vehicle key has been removed from the ignition lock.
- ⓘ If any work has to be performed when the engine is started or with the engine running, there is an additional, potentially fatal safety risk from the rotating parts, such as the poly V-belt, alternator, radiator fan, and from the high-voltage ignition system. Always be particularly careful.
- ⓘ Always ensure that no body parts, jewellery, ties, loose items of clothing or long hair can be caught up in rotating engine components. Before starting work, remove any jewellery and ties, tie up long hair and pull clothes in tightly to avoid them getting caught on engine parts.
- ⓘ Always depress the accelerator very carefully and never without paying due attention. The vehicle could move, even if the electronic parking brake is applied.
- ⓘ Always ensure you have not left any objects, such as cleaning cloths and tools, in the engine compartment. Any forgotten items can cause malfunctions, engine damage and fires.

 **WARNING**

Additional insulating materials such as blankets in the engine compartment could disrupt the operation of the engine, start fires and lead to severe injuries.

ⓘ Never cover the engine with blankets or other insulating materials.

WARNING

Service fluids and some materials in the engine compartment are highly flammable and can cause fires and serious injuries!

ⓘ Never smoke in the vicinity of the engine compartment.

ⓘ Never work near naked flames or sparks.

ⓘ Never pour service fluids over the engine. They could ignite on hot engine components and cause injuries.

ⓘ Please observe the following when carrying out any work on the fuel system or the electrical system:

ⓘ Always disconnect the 12-volt vehicle battery. Ensure that the vehicle is unlocked when the 12-volt vehicle battery is disconnected as otherwise the anti-theft alarm will be activated.

ⓘ Never work in the direct proximity of heating systems, water heaters or any other open flames.

ⓘ Always have a fully functional and tested fire extinguisher to hand.

NOTICE

When filling or changing service fluids, please ensure that the correct service fluids are filled through the correct openings. The use of incorrect service fluids could result in serious malfunctions and engine damage.



Service fluids that leak from the vehicle are harmful to the environment. For this reason, you should regularly check the ground underneath your vehicle. If there are spots of oil or other fluids on the ground, the vehicle should be inspected by a qualified workshop. Any spilt service fluids must be disposed of properly.

Preparing the vehicle for working in the engine compartment

Checklist

The following steps should always be carried out in the specified order before working in the engine compartment ⇒  :

ⓘ 

Park the vehicle on a level and stable surface.



Depress and hold the brake pedal until you have switched off the ignition.



Switch on the electronic parking brake Electronic parking brake.



Move the gear lever to neutral position Manual gearbox: selecting a gear or move the selector lever to position P DSG® dual clutch gearbox.



Switch off the ignition and remove the vehicle key from the ignition lock Starting and stopping the engine.



Allow the engine to cool sufficiently.



Children and other people should be kept well away from the engine compartment.



Ensure that the vehicle cannot roll away unexpectedly.

WARNING

Ignoring any of the items on this important safety checklist can lead to severe injuries.

Always follow the instructions in the checklist and observe the general safety procedures.

Opening and closing the bonnet

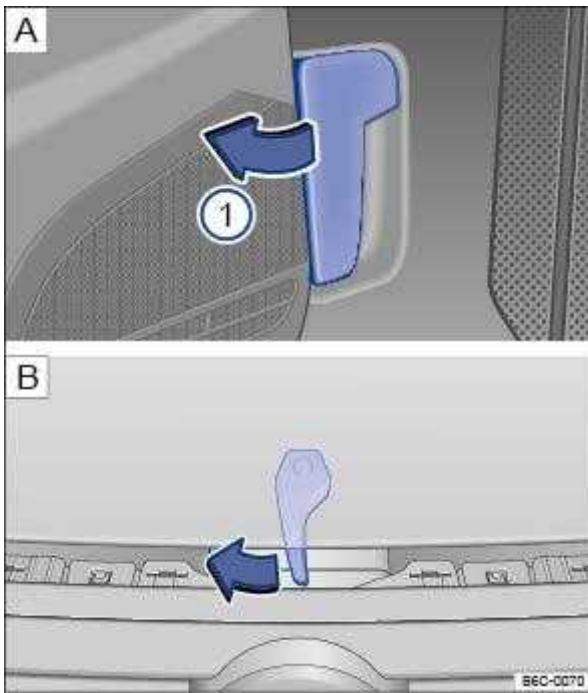

Fig. 182 In the footwell on the driver side: bonnet release lever. Above the radiator grille: bonnet opening lever.

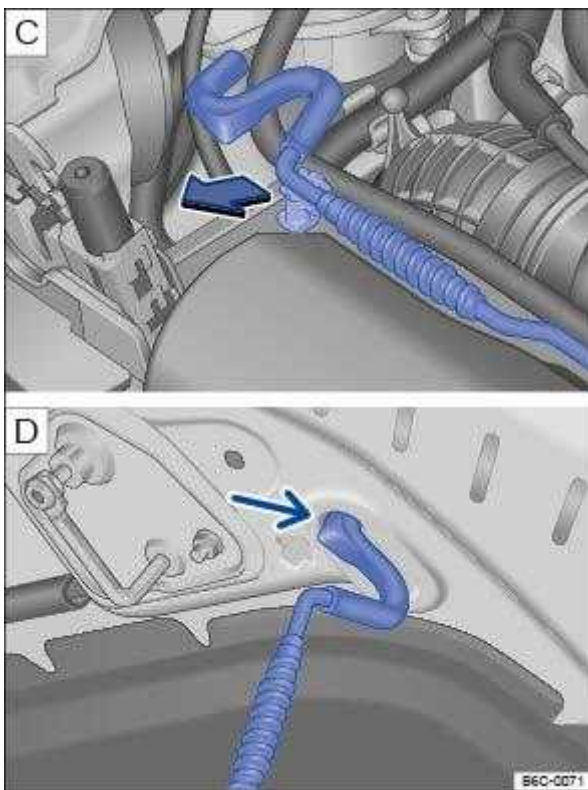









Fig. 183 In the engine compartment: bonnet stay in the holder. On the bonnet: holder for the bonnet stay.

Opening the bonnet

☑ Ensure that the windscreen wiper arms are positioned on the windscreen before opening the bonnet ⇒ .



☑ Open the driver door and pull the release lever in the direction of the arrow ⇒ Fig. 182 .   .
The bonnet is released from the lock carrier catch by spring force ⇒ .

☞ Lift the bonnet slightly and at the same time press the opening lever in the direction of the arrow ⇒ Fig. 182 .  in order to fully open the bonnet.

☞ Take the bonnet stay out of the holder ⇒ Fig. 183 .  in the direction of the arrow and insert it in the opening ⇒ Fig. 183 .

Closing the bonnet

☞ Lift the bonnet slightly ⇒ .

☞ Unhook the bonnet stay from the opening ⇒ Fig. 183  and place it in the holder ⇒ Fig. 183 . .

☞ Let the bonnet drop into the lock carrier catch from a height of about 20 cm – do not press it down!

If the bonnet has not closed properly, lift it and then close it again.

The bonnet sits flush with the body parts around it when it is closed properly.

WARNING

If the bonnet is not closed properly, it can open suddenly while you are driving and obscure your view of the road. This could lead to accidents and serious injuries.

☞ After closing the bonnet, always check that it is properly engaged in the lock carrier catch. The bonnet must be flush with the surrounding body panels.

☞ If you notice that the bonnet is not closed properly while the vehicle is in motion, stop the vehicle as soon as possible and close the bonnet.

☞ The bonnet should be opened or closed only when there is no one in its path.

NOTICE

☞ Open the bonnet only when the wipers are switched off and positioned on the windscreen in order to avoid damage to the bonnet and the wiper arms.

☞ Always return the wiper arms to the windscreen before starting your journey.

Display

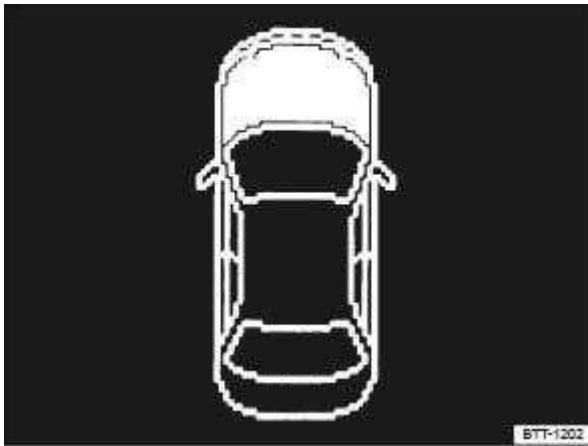



Fig. 184 On the instrument cluster display: the bonnet is open or has not been closed properly.

A symbol in the instrument cluster display ⇒ Fig. 184 indicates if the bonnet is open or is not closed properly.

 Do not drive on! If necessary, lift the bonnet and then close it again.

This symbol is also visible when the ignition is switched off and will go out a few seconds after the vehicle has been locked when all doors are closed.

WARNING

Failure to observe warnings can cause your vehicle to break down in traffic, which can lead to accidents and serious injuries.

 Never ignore any warnings.

 Stop the vehicle as soon as possible and when safe to do so.



The symbol can differ depending on the version of the instrument cluster.

Service fluids and consumables

All service fluids and consumables, e.g. tyres, coolant and vehicle batteries, are being constantly developed. The same applies to toothed belts, engine oils and spark plugs for combustion engines, for example. For this reason, service fluids and consumables should be replaced at a qualified workshop. Volkswagen dealerships always have the latest information about any changes.

WARNING

Unsuitable service fluids and consumables, and the incorrect use of these fluids and consumables, can cause accidents, serious injuries, burns or poisoning.

 Service fluids must be kept in their original sealed container.

- ⊠ Never store service fluids in empty food containers, bottles or any other non-original containers as people finding these containers could drink them.
- ⊠ Keep children away from all service fluids and consumables.
- ⊠ Always read and follow the information and warnings on the service fluid packaging.
- ⊠ When using products that give off harmful fumes, always work outdoors or in a well-ventilated area.
- ⊠ Never use fuel, turpentine, engine oil, nail varnish remover or other volatile fluids for vehicle care. These substances are toxic and highly flammable. They could cause fires and explosions.

⚠ NOTICE

- ⊠ Only use suitable service fluids for refilling. Never use the wrong service fluid. Failure to observe this can result in serious malfunctions and engine damage.
- ⊠ Accessories and other add-on parts in front of the air intake reduce the cooling effect of the coolant. The engine may overheat at high ambient temperatures and high engine loads.



Leaking service fluids can pollute the environment. Spilt service fluids must be collected in suitable containers and disposed of properly and with respect for the environment.



Washer fluid



Fig. 185 In the engine compartment: cap on the washer fluid reservoir.

The washer fluid level should be checked regularly and topped up as necessary.

A strainer is located in the neck of the washer fluid reservoir. The strainer keeps large dirt particles away from the windscreen washer jets when refilling. The strainer should be removed for only cleaning. If the strainer is damaged or is not present when refilling, dirt particles can enter the system and block the washer jets.

- ⊠ Open the bonnet  ⇒ In the engine compartment .
- ⊠ The washer fluid reservoir is identified by the  on the cap ⇒ Fig. 185 .

☒ Check whether there is sufficient washer fluid in the reservoir.

☒ To top up, mix clean water (not distilled water) with a washer fluid recommended by Volkswagen ⇒  . Observe the dilution instructions on the packaging.

☒ At low outside temperatures, add a special anti-freeze agent so that the fluid cannot freeze ⇒  .

The windscreen washer fluid reservoir has a capacity of about 3.0–7.5 litres, according to the vehicle equipment.

WARNING

Never mix coolant additive or other unsuitable additives into the washer fluid. These may leave an oily film on the screen, restricting the field of vision.

☒ Use clean, clear water (not distilled water) with a washer fluid recommended by Volkswagen.

☒ A suitable anti-freeze agent should be added to the washer fluid if necessary.

NOTICE

☒ Never mix other cleaning agents with the cleaning agents recommended by Volkswagen. This can cause the ingredients to flocculate and block the washer jets.

☒ When filling service fluids, please make sure that the correct service fluids are filled through the correct openings. The use of incorrect service fluids could result in serious malfunctions and engine damage.

Engine oil

Introduction

This chapter contains information on the following subjects:

⇒ Engine oil standards

⇒ Changing engine oil

⇒ Engine oil consumption

⇒ Checking the engine oil level and refilling the engine oil

⇒ Troubleshooting

The engine oils are not only tailored to the requirements of engines and exhaust gas treatment systems, but also to fuel quality. Due to the way in which a combustion engine works, engine oil always comes into contact with combustion residues and fuel, which has corresponding effects on the ageing process of the oil. The correct engine oil is important for the function and service life of the engine. A special multigrade high-lubricity oil has been filled at the factory and this can normally be used as an all-season oil.

Engine oils are constantly being developed and improved. Volkswagen dealerships always have the latest information about any changes. Volkswagen therefore recommends having engine oil changes done by a Volkswagen dealership.

Information for warning and indicator lamps lit up can be found in the troubleshooting at the end of the chapter ⇒ Troubleshooting .

WARNING

Incorrect handling of engine oil can cause serious burns and other injuries.

- ☒ Always wear eye protection when handling engine oil.
- ☒ Engine oil is toxic and must be stored out of the reach of children.
- ☒ Engine oil must be kept in the closed original container. This also applies to used oil until it is disposed of.
- ☒ Never use empty food containers, bottles or other containers to store engine oil as other people may then drink the engine oil.
- ☒ Regular contact with engine oil can damage the skin. Skin that has been in contact with engine oil should be washed thoroughly with water and soap.
- ☒ Engine oil becomes extremely hot when the engine is running and can scald skin severely. Always allow the engine to cool down.



Leaking or spilt engine oil can pollute the environment. Spilt service fluids must be collected and then disposed of properly and in an environmentally responsible way.

Engine oil standards



First read and observe the introductory information and safety warnings ⇒  Introduction

If possible, use only Volkswagen-approved engine oil ⇒  . To comply with the requirements of the flexible oil change service, use only approved flexible service engine oil that complies with the corresponding VW standard.

Since the quality of fuels can vary greatly between individual markets, this must be taken into account when selecting the correct engine oil.

The use of engine oils compliant with the VW 504 00, VW 507 00 and VW 508 00 specifications requires a fuel quality compliant with EN 228 (petrol) and EN 590 (diesel), or fuel of an equivalent quality. Engine oils compliant with VW 504 00, VW 507 00 and VW 508 00 are therefore unsuitable for use in a large number of markets.

If the engine has been filled with engine oil in accordance with the standards W 502 00, VW 504 00 and VW 507 00, a sticker with the relevant information will be located on the lock carrier in the engine compartment. Observe this information!

Service identification

You can check whether your vehicle is equipped for the Flexible Service QI6 (Longlife) or Fixed Service QI1, QI2, QI3, QI4, QI7 (dependent on time or mileage) in the vehicle data ⇒ Technical data or on the inside cover of this owner's manual.

Permitted engine oil standards

Petrol engines with particulate filter¹⁾

Flexible Service VW 508 00 or alternatively VW 504 00²⁾ Fixed Service VW 502 00

Petrol engines without particulate filter

Flexible Service VW 508 00 or alternatively VW 504 00 Fixed Service VW 502 00

Diesel engines with particulate filter¹⁾

Flexible Service VW 507 00 Fixed Service VW 507 00

Diesel engines without particulate filter

Flexible Service VW 507 00 Fixed Service VW 505 01

Volkswagen recommends engine oils.



NOTICE

- ❗ Do not add any additional lubricants to the engine oil. Any damage caused by the use of such additives is not covered by the warranty.
- ❗ Use only the engine oil standard that has been expressly approved by Volkswagen for the engine. Using other engine oils can cause engine damage.
- ❗ Another engine oil can be used in the event of an emergency if the listed engine oils are not available. To avoid damaging the engine, a maximum quantity of 0.5 litres of the following engine oil may be used only once until the next oil change:
 - ❗ Petrol engines: standards ACEA A3/B4 or API SN (API SM).
 - ❗ Diesel engines: standards ACEA C3 or API CJ-4.

1) Check with a qualified workshop if you are unsure whether your vehicle is equipped with a particulate filter. Volkswagen recommends using a Volkswagen dealership for this purpose.

2) Using VW 504 00 instead of VW 508 00 may cause the vehicle's emissions values to increase slightly.

Changing engine oil



First read and observe the introductory information and safety warnings ⇒  Introduction

The engine oil must be changed on a regular basis. Always observe the service intervals applicable to your vehicle ⇒ Service .

The engine oil and filter change should be carried out by a qualified workshop due to the special tools and knowledge required, this also applies to the disposal of used oil. Volkswagen recommends using a Volkswagen dealership for this purpose.

More details on the service intervals can be found in the chapter on service ⇒ Service .

Additives in the engine oil can cause new engine oil to discolour quickly. This is normal and does not mean that the engine oil should be changed more frequently.

WARNING

If, in exceptional cases, you have to carry out an oil change yourself, please observe the following:

- ☑ Always wear eye protection.
- ☑ Always allow the engine to cool down completely to avoid burns.
- ☑ Keep your arms horizontal when removing the oil drain plug with your fingers to help prevent oil from running down your arm.
- ☑ Use a suitable container to collect the used oil. It must be at least large enough to hold the entire engine filling quantity.
- ☑ Never store engine oil in empty food containers, bottles or any other non-original containers as people finding these containers may not know that they contain engine oil.
- ☑ Engine oil is toxic and must be stored out of the reach of children.



Before changing the engine oil, first find out where old oil can be disposed of properly near you.



Used oil must be disposed of in accordance with regulations governing the protection of the environment. Never dispose of used oil in locations such as gardens, woods, sewerage systems, on streets and roads, or in rivers and waterways.

Engine oil consumption



First read and observe the introductory information and safety warnings ⇒  Introduction

Engine oil consumption can vary from engine to engine and can change during the service life of an engine.

The vehicle may consume up to 1.0 litre of engine oil per 2,000 km, depending on your driving style and the conditions in which the car is used. In new vehicles, consumption may be higher for the first 5,000 km. The engine oil level must therefore be checked at regular intervals, preferably each time the vehicle is refuelled and before long journeys.

When the engine is working hard, the engine oil level should be kept within the upper permissible area ⇒ Fig. 186 ©, for instance during extended motorway journeys in summer, when towing a trailer ⇒ Trailer towing , or when climbing mountain passes.

Checking the engine oil level and refilling the engine oil

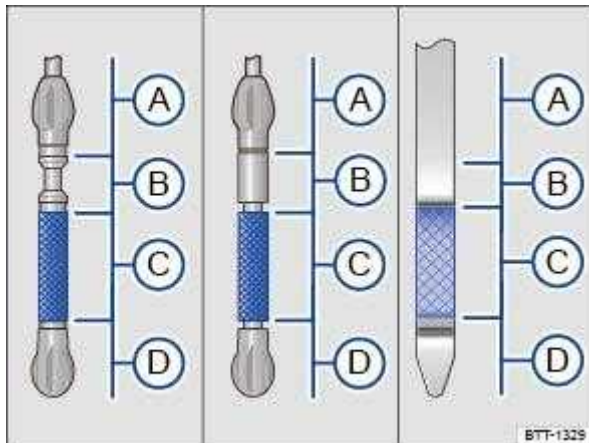

Fig. 186 Engine oil level markings on the oil dipstick (variants).



Fig. 187 In the engine compartment: engine oil filler cap (illustration).



First read and observe the introductory information and safety warnings ⇒ ⚠ Introduction

Key to ⇒ Fig. 186 :

- ☑ **A** Engine oil level too high – observe the messages on the instrument cluster display or contact a qualified workshop, if necessary.
- ☑ **B** Do not fill engine oil.
- ☑ **C** Engine oil level OK.
- ☑ **D** Engine oil level too low – fill engine oil.

Checklist

Carry out the steps in the specified order ⇒ ⚠ :



With the engine at operating temperature, park the vehicle on a level surface to ensure that the engine oil reading is correct.



Switch off the engine and wait a few minutes for the engine oil to flow back into the sump.



Open the bonnet In the engine compartment.



Identify the engine oil filler cap and oil dipstick. The engine oil filler opening can be recognised by the symbol on the cap and the oil dipstick has a coloured handle. If you cannot find the cap and dipstick, please contact a qualified workshop.



Pull the dipstick out of the guide tube and wipe it off with a clean cloth.



Insert the oil dipstick into the guide tube again as far as it will go. If there is a marking on the upper end of the oil dipstick, this marking must fit into the corresponding groove at the top end of the guide tube upon insertion.

☐ Pull the dipstick out again and read the engine oil level on the dipstick as follows: **Ⓐ** Engine oil level too high. Observe any messages that are shown on the instrument cluster display or contact a qualified workshop . **Ⓑ** Do not fill any engine oil . Continue with step 16. **Ⓒ** Engine oil level OK. Engine oil can, e.g. in the case of high engine loads , be filled up to the upper limit of this range. Continue with step 8 or 16. **Ⓓ** Engine oil level is too low. Engine oil must be filled. Continue with step 8.



After reading off the oil level, push the oil dipstick back into the guide tube as far as it will go.



Unscrew the cap of the engine oil filler opening .



Using only the engine oil approved by Volkswagen expressly for this engine, fill oil gradually in small amounts (no more than 0.5 l).



In order to avoid overfilling, wait for approximately one minute after each refill step to allow the engine oil to flow into the sump up to the marking on the engine oil dipstick.



Read the engine oil level from the dipstick again before refilling with a further small quantity of engine oil. Never overfill engine oil .



After refilling, the engine oil level should be in the middle of area ③. It should not be above ③, in area ②, and must not be in area ① .



If too much engine oil has been added unintentionally and the engine oil level is in area ①, do not start the engine. Inform a qualified workshop and seek expert assistance if necessary.



Close the engine oil filler opening with the cap after filling.



Insert the oil dipstick into the guide tube as far as it will go. If there is a marking on the upper end of the oil dipstick, this marking must fit into the corresponding groove at the top end of the guide tube upon insertion.



Close the bonnet In the engine compartment.

 **WARNING**

Engine oil can ignite if it comes into contact with hot engine components. It can cause fires, burns and other serious injuries.

☒ If engine oil is spilt on cold engine parts it can heat up and ignite when the engine is running.

☒ Always ensure that the engine oil filler cap is securely tightened after refilling, and that the dipstick is properly inserted back into the guide tube. This will prevent the engine oil from draining out on to hot engine components when the engine is running.

 **NOTICE**

☒ If too much engine oil has been added unintentionally and the engine oil level is in area ⇒ Fig. 186 ①, do not start the engine. Inform a qualified workshop and seek expert assistance if necessary. The catalytic converter and the engine could otherwise be damaged.

☑ When filling service fluids, please make sure that the correct service fluids are filled through the correct openings. The use of incorrect service fluids could result in serious malfunctions and engine damage.



The engine oil level must never be above area ⇒ Fig. 186 Ⓑ. Otherwise oil can be drawn in through the crankcase breather and escape into the atmosphere via the exhaust system.

Troubleshooting



First read and observe the introductory information and safety warnings ⇒ ⚠ Introduction



and  Engine oil pressure too low

The central warning lamp lights up red and the text message Stop vehicle. Oil pressure. Observe vehicle wallet is displayed.



Do not drive on!

Switch off the engine and check the engine oil level. Checking the engine oil level ⇒ Checking the engine oil level and refilling the engine oil . - Do not drive on or allow the engine to run if the warning lamp is flashing although the engine oil level is correct. The engine could otherwise be damaged. Seek expert assistance.



and  Engine oil level too low

The central warning lamp lights up red and the text message Refill engine oil. is displayed.

Engine oil level is too low. Switch off the engine.

Checking the engine oil level ⇒ Checking the engine oil level and refilling the engine oil .



and  Engine oil level low

The central warning lamp lights up yellow and the text message Check oil level. is displayed.

Engine oil level is low. Switch off the engine.

Checking the engine oil level ⇒ Checking the engine oil level and refilling the engine oil .



and  Fault in engine oil system

The central warning lamp lights up yellow and the text message Oil sensor: workshop. is displayed.

Engine oil system is faulty. Go to a qualified workshop and have the engine oil sensor checked.



and  Engine oil level too high

The central warning lamp lights up yellow and the text message Reduce oil level. is displayed.

Engine oil level is too high. Switch off the engine.

Check the engine oil level. Checking the engine oil level ⇒ Checking the engine oil level and refilling the engine oil . Seek expert assistance.

Coolant



Introduction

This chapter contains information on the following subjects:

⇒ Coolant specification

⇒ Checking the coolant level and refilling coolant

Do not work on the cooling system unless you are familiar with the task, aware of the general safety procedures and have the correct equipment, service fluids and suitable tools. Serious injuries can be caused by carrying out work incorrectly ⇒ ⚠️. The work should be carried out by a qualified workshop if you are uncertain. Volkswagen recommends using a Volkswagen dealership for this purpose.



WARNING

Coolant is toxic.

- ☑️ Coolant should only be kept in sealed original containers in a safe place.
- ☑️ Never store coolant in empty food containers, bottles or any other non-original containers as people finding these containers may then drink the coolant.
- ☑️ Coolant must be stored out of the reach of children.
- ☑️ Please note that the amount of correct coolant additive used must be sufficient for the lowest ambient temperature that you expect the vehicle to be exposed to.
- ☑️ Coolant can freeze at extremely cold outside temperatures, causing the vehicle to break down. Vehicle occupants with inadequate winter clothing could then freeze to death as the heating will also no longer function.



Coolant and coolant additives can pollute the environment. Spilt service fluids must be collected then disposed of properly and in an environmentally responsible way.

Coolant specification





First read and observe the introductory information and safety warnings ⇒ ⚠️ Introduction

The cooling system is filled at the factory with a mixture of specially prepared water and at least 40% coolant additive G 13 (TL-VW 774 J).

The proportion of engine coolant additive must always be at least 40% to protect the cooling system. If greater frost protection is required in very cold climates, the proportion of anti-freeze additive can be increased. However, the percentage of coolant additive should not exceed 60%, as this would reduce the frost protection again and the cooling effect.

The coolant additive is dyed purple. The mixture of water and a coolant additive offers anti-freeze protection down to -25°C (-13°F), protects the alloy parts in the cooling system against corrosion, prevents limescale deposits and significantly increases the boiling point of the coolant.

When refilling the coolant, a mixture of distilled water and at least 40% coolant additive - G 13 - or - G 12 plus-plus - (TL-VW 774 G) (both of which are dyed purple) must be used in order to obtain the optimum corrosion protection ⇒ .

Mixing - G 13 - with the coolant additives - G 12 plus - (TL-VW 774 F), - G 12 - (dyed red) or - G 11 - (dyed blue-green) will significantly decrease the level of corrosion protection and should therefore be avoided ⇒ .

WARNING

Insufficient anti-freeze in the coolant system can cause the engine to break down and cause serious injuries.

☒ Please note that the amount of correct coolant additive used must be sufficient for the lowest ambient temperature that you expect the vehicle to be exposed to.

☒ Coolant can freeze at extremely cold outside temperatures, causing the vehicle to break down. Vehicle occupants with inadequate winter clothing could then freeze to death as the heating will also no longer function.

NOTICE

Never mix genuine coolant additives with other coolants that have not been approved by Volkswagen.

☒ If the liquid in the coolant expansion tank is not pink (colouring results from mixing the purple coolant additive with distilled water) but for example, brown instead of purple, - G 13 - has been mixed with an unsuitable coolant additive. The coolant must be changed as soon as possible if this is the case. Failure to observe this warning can result in serious malfunctions or damage to the engine and cooling system.



Coolant and coolant additives can pollute the environment. Spilt service fluids must be collected and then disposed of properly and in an environmentally responsible way.

Checking the coolant level and refilling coolant

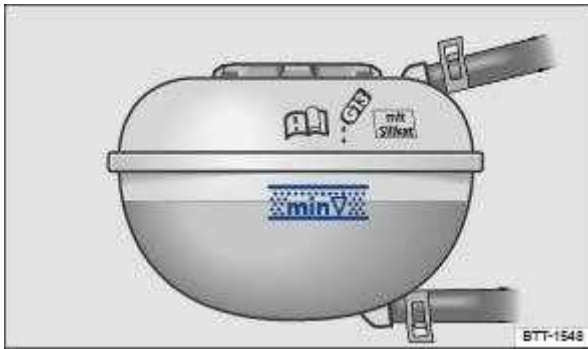

Fig. 188 In the engine compartment: markings on the coolant expansion tank.



Fig. 189 In the engine compartment: coolant expansion tank cap (illustration).

First read and observe the introductory information and safety warnings ⇒ Introduction

The warning lamp for the engine coolant will light up if the engine coolant level is too low.

Preparations

- ☐ Park the vehicle on a firm and level surface.
- ☐ Allow the engine to cool down ⇒ .
- ☐ Open the bonnet ⇒ In the engine compartment .
- ☐ The coolant expansion tank is marked by the symbol on the cap ⇒ Fig. 189 .

Checking the coolant level

- ☐ When the engine is cold, check the coolant level at the side markings of the coolant expansion tank ⇒ Fig. 188 . The coolant level must be between the marks.
- ☐ Refill coolant if the liquid level in the coolant expansion tank is below the minimum marking (min). When the engine is warm, the engine coolant level may be slightly above the maximum (MAX) mark.

Refilling coolant

- ☐ Always protect your face, hands and arms from hot coolant or steam by placing a suitable cloth on the cap of the coolant expansion tank.
- ☐ Unscrew the cap carefully ⇒ .
- ☐ Refill only with new coolant according to the Volkswagen specification ⇒ Coolant specification ⇒ .

- ☒ Refill coolant only if there is still a remaining quantity of coolant in the coolant expansion tank. Otherwise, the engine could be damaged. If you cannot see any coolant in the expansion tank do not drive on. Seek professional assistance.
- ☒ If there is still a remaining amount of coolant in the coolant expansion tank, refill coolant until the level remains stable.
- ☒ The coolant level must be between the marks on the coolant expansion tank ⇒ Fig. 188 . Do not fill up above the top edge of the marked area ⇒ ⚠ .
- ☒ Screw on the cap tightly.
- ☒ If in an emergency you do not have access to coolant with the required specification ⇒ Coolant specification , do not use any other coolant additive! Instead, initially refill with distilled water ⇒ ⚠ only. Then add the correct proportion of the specified coolant additive as soon as possible ⇒ Coolant specification .

 **WARNING**

Hot steam and hot coolant can cause serious burns.

- ☒ Never open the bonnet if you can see or hear steam or engine coolant coming out of the engine compartment. Always wait until you can no longer see or hear escaping steam or coolant.
- ☒ Always allow the engine to cool down completely before carefully opening the bonnet. Hot components can burn the skin.
- ☒ The following points must be observed before opening the bonnet once it has cooled down:
 - ☒ Switch on the electronic parking brake and move the selector lever to position P or move the gear lever to the neutral position.
 - ☒ Switch off the ignition and remove the vehicle key from the ignition lock.
 - ☒ Always keep children away from the engine compartment and never leave the vehicle unattended.
 - ☒ The cooling system is under pressure when the engine is hot. Never open the cap of the coolant expansion tank when the engine is hot. Coolant may spray out and cause serious burns and other injuries.
 - ☒ Turn the cap slowly and very carefully anti-clockwise while exerting gentle downward pressure on the cap.
 - ☒ Always protect the face, hands and arms from hot coolant or steam with a large, thick cloth.
 - ☒ When refilling, do not spill any service fluids on engine components or on the exhaust system. The spilt service fluids can start a fire. In certain circumstances, the ethylene glycol in the coolant can catch fire.

 **NOTICE**

☒ Refill only with distilled water. All other types of water can cause corrosion in the engine due to the chemical components contained in the water. This can also lead to engine failure. If any other type of water apart from distilled water has been refilled, the fluid in the cooling system should be completely replaced immediately by a qualified workshop.

☒ Do not fill coolant above the top of the marked area ⇒ Fig. 188 . Otherwise the excess coolant will be forced out of the cooling system when the engine is hot and could cause damage.

☒ If a large amount of coolant has been lost, do not refill the coolant until the engine has cooled completely. Heavy coolant loss is an indication of leaks in the cooling system. The cooling system should be checked by a qualified workshop as soon as possible. Failure to do so can result in engine damage.

☒ Do not top up with coolant if there is no more coolant in the coolant expansion tank. Air could have entered the cooling system. Do not drive on! Seek expert assistance. Failure to do so can result in engine damage.

☒ When filling service fluids, please make sure that the correct service fluids are filled through the correct openings. The use of incorrect service fluids could result in serious malfunctions and engine damage.

Brake fluid



Fig. 190 In the engine compartment: cap on the brake fluid reservoir.

Brake fluid will gradually absorb water from the surrounding air over the course of time. The brake system will be damaged if there is too much water in the brake fluid. The boiling point of the brake fluid is also considerably reduced by the water content. Heavy use of the brakes and full braking may cause a vapour lock in the brake system if the water content is too high. Vapour locks reduce levels of braking power, considerably increase braking distance and can even cause the brake system to fail completely. Your own safety and that of other road users depends on having a brake system that functions properly at all times ⇒ ⚠ .

Brake fluid specification

Volkswagen has developed a brake fluid that has been optimised for the brake system in the vehicle. To ensure optimal operation of the brake system, Volkswagen expressly recommends the use of brake fluid compliant with VW standard 501 14.

Before using a particular brake fluid, check that the brake fluid specifications printed on the container correspond to the vehicle requirements.

Brake fluid that is compliant with VW standard 501 14 is available from Volkswagen dealerships.

If this brake fluid is not available and it is necessary to use another high-quality brake fluid instead, brake fluid that is compliant with DIN ISO 4925 CLASS 4 or US standard FMVSS 116 DOT 4 can be used.

Not all brake fluids that are compliant with DIN ISO 4925 CLASS 4 or US standard FMVSS 116 DOT 4 have the same chemical composition. Some of these brake fluids may contain chemicals that can damage or destroy brake system components over time.

Volkswagen therefore recommends the use of brake fluid that is compliant with VW standard 501 14 to ensure sustained proper operation of the brake system.

Brake fluid that is compliant with VW standard 501 14 fulfils the requirements of DIN ISO 4925 CLASS 4 or US standard FMVSS 116 DOT 4.

Brake fluid level

The brake fluid level must always be between the MIN and MAX marking on the brake fluid reservoir or above the MIN marking ⇒  .

The brake fluid level cannot be checked accurately in all models as engine components may partially conceal the fluid level in the brake fluid reservoir. If the brake fluid level cannot be read exactly, please go to a qualified workshop.

The brake fluid level drops slightly during vehicle operation as the brake pads wear and the brakes are automatically adjusted.

Brake fluid level

The indicator lamp lights up red.

Brake fluid level is too low.

 Do not drive on! Check the brake fluid level.

If the brake fluid level is too low, inform a qualified workshop. Have the brake system checked.

Changing the brake fluid

The brake fluid should be changed by a qualified workshop. Volkswagen recommends using a Volkswagen dealership for this purpose. Only brake fluid that conforms with the required specification should be used.

WARNING

Brake failure or reduced braking efficiency can be caused by the brake fluid level being too low or by brake fluid that is too old or unsuitable.

☐ The brake system and brake fluid level must be checked regularly.

☐ The brake fluid should be changed regularly.

☒ Heavy use of the brakes may cause a vapour lock in the case of old brake fluid. Vapour locks reduce braking efficiency, considerably increase braking distance and can cause the brake system to fail completely.

☒ Please ensure that the correct brake fluid is used. Only use brake fluid that is explicitly compliant with VW standard 501 14.

☒ Any other brake fluid or low-quality brake fluid can affect the functioning of the brakes and reduce their effectiveness.

☒ If a brake fluid compliant with VW standard 501 14 is not available, use a high-quality brake fluid compliant with DIN ISO 4925 CLASS 4 or the US standard FMVSS 116 DOT 4, but only in exceptional circumstances.

☒ The refilled brake fluid must be new.

WARNING

Brake fluid is toxic.

☒ In order to reduce the risk of poisoning, never use drinks bottles or other containers to store brake fluid. There is always a risk of someone drinking from such containers, even if they are labelled appropriately.

☒ Brake fluid must always be stored in its original sealed container and kept out of the reach of children.

NOTICE

Brake fluid that has leaked or been spilt can damage the vehicle paintwork, plastic parts and tyres. Immediately wipe off brake fluid that has leaked or been spilt from all parts of the vehicle.



Brake fluid can pollute the environment. Any service fluids that have escaped or been spilt must be collected and disposed of properly.

12-volt vehicle battery

Introduction

This chapter contains information on the following subjects:

⇒ Checking the electrolyte level of the 12-volt vehicle battery

⇒ Charging, replacing, disconnecting and connecting the 12-volt vehicle battery

⇒ Troubleshooting

The 12-volt vehicle battery is a component of the electrical system and serves to supply power in the vehicle.

Do not work on the electrical system unless you are familiar with the task, aware of the general safety procedures and have the correct equipment, service fluids and suitable tools. Serious injuries can be caused by carrying out work incorrectly ⇒ ⚠️. All work should be carried out by a qualified workshop. Volkswagen recommends using a Volkswagen dealership for this purpose.

Information for warning and indicator lamps lit up can be found in the troubleshooting at the end of the chapter ⇒ Troubleshooting .

Location of the 12-volt vehicle battery

The 12-volt vehicle battery is located in the engine compartment.

Explanation of the warnings on the 12-volt vehicle battery

Always wear eye protection! Electrolyte is very corrosive and caustic. Always wear protective gloves and eye protection! Fire, sparks, naked lights and smoking are prohibited!

A highly explosive mixture of gases is given off when the 12-volt vehicle battery is charging!

Always keep children away from electrolyte and the 12-volt vehicle battery! Always observe the owner's manual!

WARNING

Any work on the 12-volt vehicle battery and the electrical system can cause serious chemical burns, fire or electric shocks. Always read and observe the following warnings and safety information before carrying out any kind of work:

- ☐ Switch off the ignition and all electrical consumers before carrying out any work on the 12-volt vehicle battery and also disconnect the negative cable from the 12-volt vehicle battery.
- ☐ Children should always be kept away from electrolyte and the 12-volt vehicle battery.
- ☐ Always wear eye protection and protective gloves.
- ☐ Electrolyte is very aggressive. It can burn the skin and can cause blindness. When working with the 12-volt vehicle battery, ensure that your hands, arms and face in particular are protected from acid spillages.
- ☐ Do not smoke during the work, and never work near naked flames or sparks.
- ☐ Avoid generating sparks when handling cables and electrical devices and from electrostatic discharge.
- ☐ Never short circuit the battery terminals.
- ☐ Never use a damaged 12-volt vehicle battery. It can explode. Damaged 12-volt vehicle batteries must be replaced as soon as possible.

ⓘ Never use a frozen 12-volt vehicle battery. Discharged 12-volt vehicle batteries can already freeze at temperatures of around 0°C (+32°F). Frozen 12-volt vehicle batteries must be renewed immediately.

ⓘ NOTICE

Do not expose the 12-volt vehicle battery to direct daylight for an extended time.

ⓘ The ultraviolet radiation can damage the battery housing.

ⓘ NOTICE

Protect the 12-volt vehicle battery against frost if the vehicle is left standing for extended periods.

ⓘ The 12-volt vehicle battery can freeze and be destroyed as a result.



When you start the engine after the 12-volt battery has been totally discharged or after jump starting, you may find that system settings (time, date, personal convenience settings and programming) have been changed or deleted. Check and correct the settings as necessary once the 12-volt vehicle battery has been sufficiently charged.

Checking the electrolyte level of the 12-volt vehicle battery

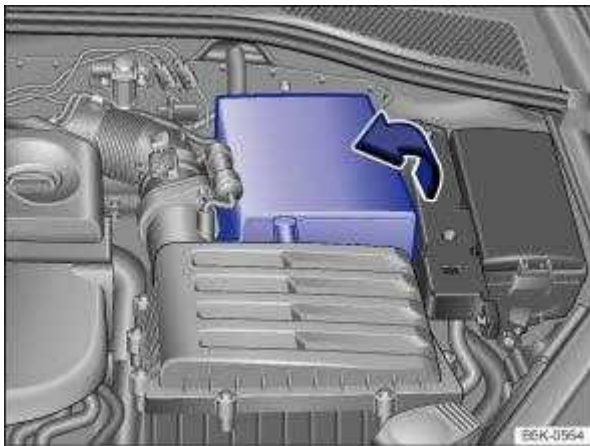

Fig. 191 In the engine compartment: folding open the 12-volt vehicle battery cover.



Fig. 192 Battery window on the top of the 12-volt vehicle battery (illustration).



First read and observe the introductory information and safety warnings ⇒ ⚠ Introduction

The electrolyte level of the 12-volt vehicle battery should be checked regularly in high-mileage vehicles, in hot countries and in older 12-volt vehicle batteries. The 12-volt vehicle battery is otherwise maintenance-free.

Vehicles with an auxiliary heater ⇒ Auxiliary heater and ventilation are fitted with special vehicle batteries. The electrolyte level of these 12-volt vehicle batteries cannot be checked for technical reasons. Go to a qualified workshop to have the 12-volt vehicle battery checked.

Preparations

☑ Preparing the vehicle for working in the engine compartment ⇒ In the engine compartment .

☑ Open the bonnet ⚠ ⇒ In the engine compartment .

Checking the electrolyte level (12-volt vehicle batteries with battery window)

☑ Ensure that enough light is available for you to clearly see the colour indicator in the round battery window on the top of the 12-volt vehicle battery ⇒ Fig. 192 (arrow). Never use naked flames or glowing objects as a light source.

☑ The colour displayed in the round battery window changes according to the electrolyte level in the 12-volt vehicle battery.

Light yellow or without colour The electrolyte level of the 12-volt vehicle battery is too low. The 12-volt vehicle battery should be checked and replaced by a qualified workshop if necessary. Black The electrolyte level of the 12-volt vehicle battery is correct.

⚠ WARNING

Any work on the 12-volt vehicle battery can cause serious chemical burns, explosions and electric shocks.

☑ Always wear eye protection and protective gloves.

☒ Electrolyte is very aggressive. It can burn the skin and can cause blindness. When working with the 12-volt vehicle battery, ensure that your hands, arms and face in particular are protected from acid spillages.

☒ Never tilt the 12-volt vehicle battery. Electrolyte may spill out of the battery vents and cause chemical burns.

☒ Never open a 12-volt vehicle battery.

☒ If acid is spilt in your eye or on your skin, rinse immediately for several minutes with cold water. Then consult a doctor immediately.

☒ If electrolyte is swallowed, consult a doctor immediately.

Charging, replacing, disconnecting and connecting the 12-volt vehicle battery



First read and observe the introductory information and safety warnings ⇒ ⚠ Introduction

If you suspect that the 12-volt vehicle battery is damaged or faulty, go to a qualified workshop and have the 12-volt vehicle battery checked.

Charging the 12-volt vehicle battery

The 12-volt vehicle battery should be charged by a qualified workshop, as the technology used in factory-fitted 12-volt vehicle batteries requires voltage-limited charging ⇒ ⚠. Volkswagen recommends using a Volkswagen dealership for this purpose.

Replacing the 12-volt vehicle battery

The 12-volt vehicle battery has been developed to suit the conditions of its installation location and has special safety features. If a 12-volt vehicle battery has to be replaced, find out about the electromagnetic compatibility, size and necessary maintenance, power and safety requirements for the new 12-volt vehicle battery at a Volkswagen dealership before purchase. The ventilation opening of the vehicle battery must always be on the negative terminal side: the ventilation opening on the positive terminal side must always be sealed.

Only maintenance-free vehicle batteries compliant with the standards TL 825 06 and VW 7 50 73 should be used. These standards must be dated October 2014 or later.

Always have the 12-volt vehicle battery replaced by a qualified workshop, as the vehicle electronics must be adapted as part of the replacement process. Only qualified workshops have the technology required to carry out this adjustment correctly. Volkswagen recommends that the 12-volt vehicle battery is replaced by a Volkswagen dealership.

Disconnecting the 12-volt vehicle battery

Please observe the following if the 12-volt vehicle battery has to be disconnected from the electrical system in the vehicle:

☒ Switch off all electrical consumers and the ignition.

☒ Unlock the vehicle before disconnecting the battery in order to avoid triggering the anti-theft alarm.

☒ First disconnect the negative cable and then the positive cable ⇒ ⚠.

Connecting the 12-volt vehicle battery

☒ Switch off all electrical consumers and the ignition before reconnecting the 12-volt vehicle battery.

☒ First reconnect the positive cable and then the negative cable ⇒ ⚠ .

Various indicator lamps may light up after the 12-volt vehicle battery has been connected and the ignition is switched on. They will go out when you drive a short distance at a speed of approximately 15 – 20 km/h (10 – 12 mph). If the indicator lamps remain lit up, the vehicle should be checked by a qualified workshop.

If the 12-volt vehicle battery was disconnected for an extended period, the system may not be able to calculate or correctly display the time when the next service is due ⇒ Instrument cluster . Observe the maximum permissible service intervals ⇒ Service .

Automatic switch-off for electrical consumers

The intelligent vehicle electrical system management function automatically implements a range of measures to prevent the 12-volt vehicle battery from discharging under high loads:

☒ The idling speed is increased so that the alternator provides more power.

☒ The power of large electrical consumers may be reduced or they may be switched off completely.

☒ The power supply to the 12-volt socket and the cigarette lighter may be interrupted temporarily while the engine is being started.

The vehicle electricals management system cannot always prevent the 12-volt vehicle battery from being discharged, for example if the ignition is left on over a long period with the engine off or the side lights or parking lights are left on over a long period of time.

12-volt vehicle battery is discharged

☒ Due to long standing periods without running the engine, especially if the ignition is switched on.

☒ Due to use of electrical consumers when the engine is switched off.

☒ When the auxiliary heater is being used ⇒ Auxiliary heater and ventilation .

.

WARNING

Incorrectly mounting the battery and using incorrect 12-volt vehicle batteries can cause short circuits, fire and serious injuries.

☒ Always use maintenance-free and leak-proof 12-volt vehicle batteries that have the same properties, specifications and dimensions as the factory-fitted 12-volt vehicle battery.

.

WARNING

A highly explosive mixture of gases is given off when the 12-volt vehicle battery is being charged.

- ⓘ 12-volt vehicle batteries should be charged only in well-ventilated spaces.
- ⓘ Never charge a frozen or thawed 12-volt vehicle battery. Discharged 12-volt vehicle batteries can already freeze at temperatures of around 0°C (+32°F).
- ⓘ The 12-volt vehicle battery must be replaced if it has ever been frozen.
- ⓘ Incorrectly connected cables can cause a short circuit. First connect the positive cable and then the negative cable.

NOTICE

- ⓘ Never connect or disconnect 12-volt vehicle batteries if the ignition is switched on or the engine is running. Never use a 12-volt vehicle battery that does not correspond with the vehicle's specifications. This can damage the electrical system or electronic components and electrical malfunctions can occur.
- ⓘ Never connect equipment that supplies electric power, such as solar panels or a battery charger, to the 12-volt socket or to the cigarette lighter in order to charge the 12-volt vehicle battery. The electrical system of the vehicle could otherwise be damaged.



12-volt vehicle batteries may contain toxic substances such as sulphuric acid and lead. Dispose of the 12-volt vehicle battery in accordance with the regulations.



Electrolyte can pollute the environment. Collect any service fluids that escape or are spilt and dispose of them properly.

Troubleshooting



First read and observe the introductory information and safety warnings ⇒  Introduction



Vehicle battery (12-volt)

The indicator lamp lights up red.

Fault in the alternator. The 12-volt vehicle battery will not be charged by the alternator while the vehicle is in motion.

Switch off any electrical consumers that are not required. Inform a qualified workshop. Have the electrical system checked.

The start/stop system cannot start the engine ⇒ Start/stop system .





and  vehicle battery (12-volt)

The central warning lamp lights up red and the text message 12 V battery not charging. Stop vehicle. is displayed.

Fault in the alternator. The 12-volt vehicle battery will not be charged by the alternator while the vehicle is in motion.

Switch off any electrical consumers that are not required. Inform a qualified workshop. Have the electrical system checked.

The start/stop system cannot start the engine ⇒ Start/stop system .



 and  vehicle battery (12-volt)

The central warning lamp lights up yellow and the text message 12 V battery low. Charge by driving. is displayed.

The charge level of the vehicle battery is insufficient.

Recharge the 12-volt vehicle battery by driving the vehicle for an extended time.

The start/stop system cannot start the engine ⇒ Start/stop system .

 and  vehicle battery (12-volt)

The central warning lamp lights up red and the text message Replace 12 V battery. Workshop. is displayed.

The vehicle battery condition is not ok.

Seek expert assistance and have the battery checked and replaced if necessary.

The start/stop system cannot start the engine ⇒ Start/stop system .

Wheels and tyres

Tyre monitoring system

 Introduction

This chapter contains information on the following subjects:

⇒ Tyre Pressure Loss Indicator

⇒ Troubleshooting for Tyre Pressure Loss Indicator

The tyre monitoring system warns the driver when the tyre pressures are too low.

The tyre monitoring system monitors various parameters (for example, rolling circumference) of all wheels using ABS sensors (indirect measurement).

 **WARNING**

The intelligent tyre monitoring system technology cannot overcome the laws of physics, and functions only within the limits of the system. Incorrect handling of the wheels and tyres can lead to a sudden loss of pressure in the tyres, tread separation and even tyre blow-out.

☒ Check tyre pressures regularly and always maintain the specified tyre pressure value ⇒ Tyre pressure . If the tyre pressure is too low, it is possible that the tyre temperature will increase to such an extent that the tread peels off and the tyre bursts.

☒ Always maintain the correct cold tyre pressure as specified on the sticker ⇒ Tyre pressure .

☒ Check the tyre pressure regularly when the tyres are cold. If necessary, adjust the tyre pressure in the cold tyre to the recommended tyre pressure for the tyres installed on your vehicle ⇒ Tyre pressure .

☒ Check your tyres regularly for signs of wear or damage.

☒ Never exceed the top speed and load permitted for the fitted tyres.



If the tyre pressure is too low, this will increase fuel consumption and tyre wear.



When new tyres are driven at high speeds for the first time, they can expand slightly and trigger a one-off pressure warning.



Old tyres should be replaced only by tyres that have been approved by Volkswagen for the vehicle type.



Do not rely solely on the tyre monitoring system. Check your tyres regularly to ensure that they are properly inflated and have no signs of damage, such as punctures, cuts, cracks, and blisters. Remove any objects that become embedded in the tyre tread but have not penetrated into the body of the tyre itself.

Tyre Pressure Loss Indicator



First read and observe the introductory information and safety warnings ⇒ ⚠️ Introduction

Functional description

The Tyre Pressure Loss Indicator uses data from the ABS sensors and other functions to compare the speed of rotation and the rolling circumference of the individual wheels.

The rolling circumference can change:

☒ If the tyre pressure has been changed.

☒ If the tyre pressure is too low.

☒ If the tyre has structural damage.

☒ If the vehicle is loaded more heavily on one side.

☒ If snow chains have been fitted.

☒ If a temporary spare wheel has been fitted.

☒ If one wheel per axle has been changed.

The Tyre Pressure Loss Indicator  may react with a delay or not display anything at all in the event of a sporty driving style, when driving on snow-covered or icy roads or unpaved roads or when driving with snow chains.

Synchronising the Tyre Pressure Loss Indicator

☒ Switch on the ignition.

☒ Press the **MENU** button or function button, depending on version ⇒ Vehicle settings menu .

☒ Open the Vehicle menu in the Infotainment system.

☒ Depending on version, touch function button Settings.

☒ Touch the Tyres function button.

☒ Touch the SET function button.

☒ When all four tyre pressures correspond to the required values, touch the Confirm function button.

After an extended driving time with driving at different speeds, the system will automatically learn the new values and monitor them.

☒ If the tyre pressures have been changed.

☒ If one or more wheels have been changed.

☒ If the wheels have been swapped round, e.g. from front to rear.



The Tyre Pressure Loss Indicator does not work if there is a fault in the ESC or ABS
⇒ Troubleshooting .



After a warning about the tyre pressure being too low, switch the ignition off and then back on again. The Tyre Pressure Loss Indicator can be re-synchronised only after this has been done.

Troubleshooting for Tyre Pressure Loss Indicator



First read and observe the introductory information and safety warnings ⇒  Introduction



lit up

☒  Do not drive on!

☒ Check and adjust all tyre pressures ⇒ Tyre pressure .

☒ Damaged tyres should be replaced.

☒ Re-synchronise the Tyre Pressure Loss Indicator ⇒ Tyre Pressure Loss Indicator .

☒ If the problem persists, seek expert assistance.

 flashes for 65 seconds and then remains lit continuously

☒  Do not drive on!

☒ Switch the ignition off and then back on again.

☒ Re-synchronise the Tyre Pressure Loss Indicator ⇒ Tyre Pressure Loss Indicator .

☒ If the problem persists, seek expert assistance.

WARNING

Differing tyre pressures or tyre pressures that are too low can cause tyre damage, tyre failure, loss of vehicle control, accidents, serious injury and death.

☒ If the indicator lamp  lights up, stop the vehicle as soon as possible and check all the tyres
⇒ Useful information about wheels and tyres .

☒ Differing tyre pressures or tyre pressures that are too low can increase wear on the tyres, reduce vehicle stability and increase the braking distance.

☒ Differing tyre pressures or tyre pressures that are too low can cause sudden tyre failure and lead to a tyre bursting and the loss of control over the vehicle.

☒ The driver is responsible for the correct tyre pressure of all tyres on the vehicle. The recommended tyre pressure can be found on a sticker ⇒ Tyre pressure .

☒ The tyre monitoring system cannot function correctly unless all cold tyres have the correct tyre pressure.

☒ The pressure in all tyres must always be appropriate to the vehicle load ⇒ Tyre pressure .

☒ Always inflate all tyres to the correct tyre pressure before every journey ⇒ Tyre pressure .

☒ If the vehicle is driven with insufficient tyre pressure, this results in greater tyre flexing. This could warm up the tyre to such an extent that the tread may separate and the tyre could burst. This could cause the driver to lose control of the vehicle.

☒ High speeds and overloading of the vehicle may cause the tyres to heat up to such an extent that the tyre bursts, leading you to lose control of the vehicle.

☒ If the tyre pressure is too low or too high, the tyres will wear prematurely and the vehicle will not handle well.

☒ If the tyre is not flat and it is not necessary to change the wheel immediately, drive at low speed to the nearest qualified workshop and check and correct the tyre pressure ⇒ Useful information about wheels and tyres .



Driving on unpaved roads for long periods or a sporty driving style can temporarily deactivate the Tyre Pressure Loss Indicator. In the event of a malfunction, the indicator lamp will flash for 65 seconds and then light up continuously. However, the indicator lamp will go out when the road conditions or driving style change.

Useful information about wheels and tyres



Introduction

This chapter contains information on the following subjects:

- ⇒ Handling wheels and tyres
- ⇒ Wheel rims and wheel bolts
- ⇒ Tyre pressure
- ⇒ Tread depth and wear indicators
- ⇒ Tyre damage
- ⇒ Spare wheel or temporary spare wheel
- ⇒ Tyre lettering and tyre type
- ⇒ Maximum load and speed range for tyres
- ⇒ Winter tyres
- ⇒ Snow chains

The tyres are the most heavily loaded and most underestimated parts of a vehicle. Tyres are very important as the narrow tyre contact surfaces are the only contact between the vehicle and the road.

The service life of tyres is dependent on tyre pressure, driving style, handling and correct fitting.



WARNING

New tyres or tyres which are old, worn down or damaged cannot provide full vehicle control and braking efficiency.

- ☒ Incorrect handling of wheels and tyres can reduce vehicle safety and cause accidents and serious injuries.
- ☒ All four wheels must be fitted with radial tyres of the same type, size (rolling circumference) and the same tread pattern.
- ☒ New tyres must be run in as they initially have reduced grip and braking efficiency. Drive particularly carefully for the first 600 km in order to prevent accidents and serious injury.
- ☒ Check tyre pressures regularly when the tyres are cold, and always keep to the specified value. If the tyre pressure is too low, it is possible that the tyre temperature will increase to such an extent when driving that the tread peels off and the tyre bursts.

- ⓘ Never drive with worn tyres or tyres that are damaged (cuts, cracks or blisters). Driving with tyres in this condition can result in blown tyres, accidents and serious injuries. Worn or damaged tyres must be replaced as soon as possible.
- ⓘ Never exceed the top speed and load permitted for the fitted tyres.
- ⓘ The effectiveness of the driver assist systems and brake support systems also depends on the tyre grip.
- ⓘ If you notice unusual vibrations or if the vehicle pulls to one side when driving, stop the car immediately and check the wheels and tyres for damage.
- ⓘ In order to reduce the risk of losing control of the vehicle, and the risk of accident and serious injury, never loosen the bolts on wheel rims with bolted-on rim rings.
- ⓘ Do not use wheels or tyres if you do not know their history. Used wheels and tyres could be damaged, even if the damage is not visible.
- ⓘ Even if they have not been used, old tyres can suddenly lose pressure or burst, especially at high speeds, and thus cause accidents and serious injuries. Avoid using tyres that are more than six years old. If you have no alternative, drive slowly and with extra care at all times.

⚠ WARNING

If the wheels are incorrectly fastened or if wheel bolts are missing, the wheels could come loose, leading to a loss of control over the vehicle, causing accidents and serious injuries.

- ⓘ Never drive if wheel bolts are missing or loose.
- ⓘ Always use wheel bolts that match the wheel rims and the vehicle type.
- ⓘ Always tighten the wheel bolts with the correct tightening torque. If no torque wrench is available, tighten the wheel bolts with the wheel wrench and have the torque checked without delay by the nearest qualified workshop.

Handling wheels and tyres

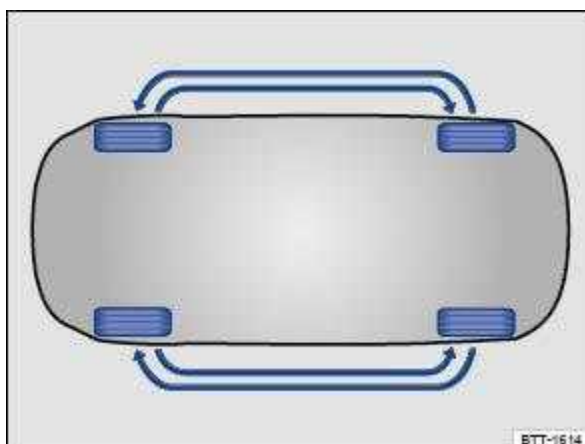

Fig. 193 Illustration: diagram showing how to swap wheels

The tyres and wheel rims approved by Volkswagen have been carefully selected.

Rotating wheels

Regularly rotating the wheels as shown in the illustration ⇒ Fig. 193 is recommended to help ensure that tyres wear evenly. All the tyres will then last for about the same time.

Volkswagen recommends having the wheels changed by a qualified workshop.

Avoiding damage to the wheel rims and tyres

- ☒ Always drive over kerbs slowly and at a right angle.
- ☒ Check the tyre pressure on a regular basis.
- ☒ Never exceed the top speed and load permitted for the tyres that are fitted ⇒ Tyre lettering and tyre type .
- ☒ Damaged or worn tyres must be replaced immediately ⇒ Tyre damage .
- ☒ Protect the tyres from contact with aggressive substances, including grease, oil, petrol and brake fluid ⇒ ⚠ .
- ☒ Replace missing dust caps on the valves immediately.

Tyres that are older than 6 years

Tyres age through physical and chemical processes that can impair their function. Tyres that have been stored unused for an extended period of time age more quickly than tyres that are used all the time.

Volkswagen recommends replacing tyres that are older than 6 years with new tyres. This also applies to tyres which appear to still be in good condition and whose tread depth has not yet reached the minimum value stipulated by legislation ⇒ ⚠ .

Winter and all-year tyres also largely lose their effectiveness through ageing – regardless of the remaining tread depth.

The age of each tyre can be determined using the manufacturing date ⇒ Tyre lettering and tyre type .

Storing tyres

- ☒ Always store tyres in a cool, dry and preferably dark place. Do not store tyres mounted on the wheel rim vertically.
- ☒ Any tyres not fitted on wheel rims should be kept in suitable sleeves to protect against dirt and should be stored vertically (standing on the tread).

New tyres

- ☒ Drive particularly carefully for the first 600 km with new tyres as the tyres have to be run in. Tyres that have not been run in have reduced grip ⇒ ⚠ and braking efficiency ⇒ ⚠ .
- ☒ All four wheels must be fitted with tyres of the same type, size, and the same tread pattern.

Replacing tyres

- ☑ Always replace tyres at least on an axle-by-axle basis ⇒ ⚠.
- ☑ Old tyres should be replaced only by tyres that have been approved by Volkswagen for the vehicle type.
- ☑ Never use tyres with an effective size that is larger than Volkswagen-approved tyres.

Re-synchronising the Tyre Pressure Loss Indicator

The Tyre Pressure Loss Indicator must be re-synchronised each time one or more wheels is changed. This also applies if the wheels have been swapped, e.g. from the front to the rear ⇒ Tyre monitoring system .

WARNING

Aggressive liquids and other substances can cause visible and invisible damage to the tyres, which can cause the tyre to burst.

- ☑ Always keep chemicals, oils, lubricants, fuel, brake fluids and other aggressive substances away from the tyres.

WARNING

Even if they have not been used, old tyres can suddenly lose pressure or burst, especially at high speeds, and thus cause accidents and serious injuries.

- ☑ Avoid using tyres that are more than six years old. If you have no alternative, drive slowly and with extra care at all times.

WARNING

New tyres must be run in as they initially have reduced grip and braking efficiency.

- ☑ Drive particularly carefully for the first 600 km in order to prevent accidents and serious injury.

WARNING

Wheels must have the necessary clearance. If the wheels do not have the necessary clearance, the tyre could rub on parts of the running gear, vehicle body and the brake lines. This can lead to a fault in the brake system and to tread separation and thus to a tyre bursting.

- ☑ The actual tyre size must not exceed the tyre dimensions of tyre makes approved by Volkswagen and must not rub on any vehicle body parts.

NOTICE

Avoid heavy impacts and drive round obstacles whenever possible. Tyres can be deformed by potholes and kerb edges especially. This can cause damage to the tyres and wheel rims.



Old tyres should be disposed of as required by legislation.



Volkswagen-approved tyres are guaranteed to have the dimensions that are suitable for the vehicle. In the case of other tyres, the tyre seller must provide a certificate from the tyre manufacturer stating that the tyre is also suitable for the vehicle. This certificate must be stored in a safe place in the vehicle.

Wheel rims and wheel bolts



First read and observe the introductory information and safety warnings ⇒  Introduction

Wheel rims, tyres and wheel bolts are matched to the vehicle type. If different wheel rims are fitted, the correct wheel bolts with the correct length and correctly shaped bolt heads must be used.

For technical reasons, it is not generally possible to use the wheel rims from other vehicles. This can also apply to wheel rims of the same vehicle type.

The tightening torque of the wheel bolts must be checked regularly with a properly functioning torque wrench.

Wheel bolts





The correct wheel bolts must be used for each vehicle type; these bolts must always be tightened with the correct tightening torque ⇒ Wheel bolts .

Wheel rims with bolted rim rings or trim elements

Rims with bolted-on rings or trim elements consist of several components. These components are joined together using special bolts. Damaged wheel rims must be replaced and must always be repaired only by a qualified workshop. Volkswagen recommends using a Volkswagen dealership for this purpose ⇒  .

Wheel rim identification

In some countries, new wheel rims must contain information on certain properties. The following information may appear on the wheel rim:

-  Seal of conformity
-  Rim size
-  Name of manufacturer or brand name
-  Date manufactured (month/year)
-  Country of origin

☐ Production number

☐ Raw materials batch number

☐ Product code

⚠ WARNING

The use of unsuitable or damaged wheel rims can impair vehicle safety and cause accidents and serious injuries.

☐ Use only wheel rims that have been approved for the vehicle.

☐ Replace wheel rims in the event of damage.

⚠ WARNING

Incorrect loosening and tightening of the bolts on wheel rims with bolted-on rings can cause accidents and serious injuries.

☐ Never loosen the bolted connections on wheel rims with bolted-on rings.

☐ All work on rims with bolted-on rings must be carried out by a qualified workshop. Volkswagen recommends using a Volkswagen dealership for this purpose.

Tyre pressure

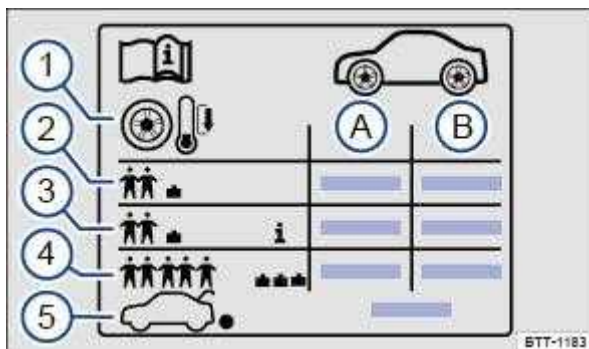

Fig. 194 Symbols on the tyre pressure sticker.



Fig. 195 On the driver door pillar: tyre pressure sticker (alternatively on the inside of the tank flap).



First read and observe the introductory information and safety warnings ⇒ Introduction

Information on the sticker ⇒ Fig. 194 :

- ☐ **A** Tyre pressure for the tyres on the front axle.
- ☐ **B** Tyre pressure for the tyres on the rear axle.
- ☐ **1** Note: check the tyre pressure when the tyres are cold.
- ☐ **2** Tyre pressure for partial load.
- ☐ **3** Vehicle-dependent: comfort tyre pressure for partial load.
- ☐ **4** Tyre pressure for full load.
- ☐ **5** Tyre pressure level for the spare or temporary spare wheel.

The sticker provides the correct tyre pressure for approved tyres and is located either on the driver door pillar ⇒ Fig. 195 or inside the tank flap.

The appearance of the sticker may differ between vehicles. It may include additional tyre sizes.

The wrong tyre pressure will have a negative effect on the vehicle handling and leads to high levels of wear or even a burst tyre ⇒ . The correct tyre pressure is particularly important at high speeds.

Comfort tyre pressure

Depending on the vehicle, the tyre pressure sticker may show details of a comfort tyre pressure ⇒ Fig. 194 **3**. The comfort tyre pressure allows increased driving comfort. Fuel consumption may increase when driving with comfort tyre pressure.

Checking the tyre pressure

- ☐ Check the tyre pressure at least once a month.
- ☐ Always check the tyre pressure when the tyres are cold. The specified tyre pressure applies to cold tyres. Tyre pressure is always higher in warm tyres than it is in cold tyres. For this reason, never reduce the pressure in warm tyres to adjust the tyre pressure.
- ☐ Always adjust the tyre pressure to the load level ⇒ Fig. 194 **4**.
- ☐ After adjusting the tyre pressures, always screw the caps onto the valves and observe the information on the tyre monitoring system.
- ☐ Always use the tyre pressure specified on the sticker. Never exceed the maximum tyre pressure which is given on the sidewall of the tyre.



WARNING

Incorrect tyre pressure may cause the tyre to suddenly lose air or burst while the vehicle is in motion. This can cause serious accidents and fatal injuries.

☒ If the tyre pressure is too low, it is possible that the tyre temperature will increase to such an extent when driving that the tread peels off and the tyre bursts.

☒ Fast speeds and overloading of the vehicle can cause overheating, sudden tyre damage including tyre bursts and ripping of the tread surface and thus to a loss of control of the vehicle.

☒ If the tyre pressure is incorrect, the tyres will wear prematurely and the car will not handle well.

☒ Check tyre pressures regularly, but at least once a month, and also before every long journey.

☒ All tyres must have the correct tyre pressure to suit the vehicle load.

☒ Never reduce excess pressure when the tyres are warm.

⚠ NOTICE

☒ When attaching the tyre pressure gauge, ensure that you do not position it at an angle to the valve stem. This can damage the tyre valve.

☒ Always make sure the valve caps are completely screwed on while driving.



Underinflated tyres will result in increased fuel consumption.

Tread depth and wear indicators

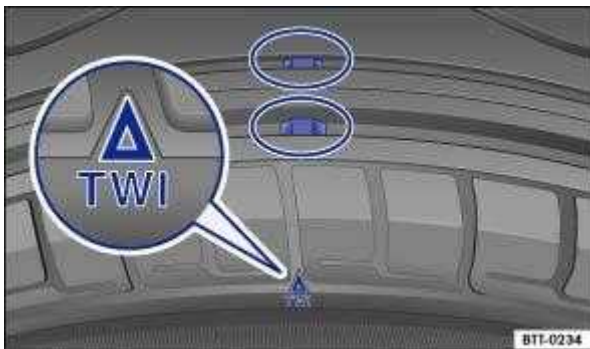

Fig. 196 Tyre tread: wear indicators.



First read and observe the introductory information and safety warnings ⇒ ⚠ Introduction

Tread depth

In most countries, the minimum tread depth required by law is 1.6 mm (measured in the tread grooves next to the tread wear indicators); observe any differing country-specific regulations. The tyres should have the same tread depth, at the minimum on each axle ⇒ ⚠ .

Observe any country-specific legal requirements relating to the permissible minimum tread depths for winter and all-year tyres.

Tread wear indicators in tyres

The tread wear indicators show if a tyre is worn down. The tyre must be replaced at the latest when the tread is worn down to the tread wear indicator.

The bottom of the tyre tread has 1.6 mm high tread wear indicators ⇒ Fig. 196 . Markings on the tyre sidewall indicate the position of the wear indicators ⇒ Fig. 196 .

WARNING

Worn tyres are a safety risk and can lead to a loss of control over the vehicle and cause serious injuries.

☒ Tyres must be replaced by new tyres at the latest when the tread is worn down to the tread wear indicators.

☒ Worn tyres have considerably less grip, particularly on wet roads, which can cause the vehicle to float along the road surface (aquaplaning).

☒ Worn tyres reduce the possibility of controlling the vehicle well in normal and difficult driving situations and increase braking distance and the risk of skidding.

Tyre damage



First read and observe the introductory information and safety warnings ⇒  Introduction

Damage to tyres and wheel rims is often hidden ⇒  .

☒ If you suspect that a wheel is damaged, stop the vehicle as soon as it is safe to do so.

☒ Check the tyres and wheel rims for damage.

☒ Do not drive on if a tyre is damaged. Replace the damaged wheel ⇒ Changing a wheel or seal the tyre with the breakdown set and inflate it ⇒ Breakdown set . Seek expert assistance if necessary.

☒ If there is no visible damage, drive slowly and carefully to the next qualified workshop in order to have the vehicle checked.

Foreign bodies in the tyre

☒ Leave the foreign body in the tyre if it has entered the inner tyre. Foreign bodies that are stuck between the tyre tread blocks can be removed.

☒ Replace the damaged wheel ⇒ Changing a wheel or seal the tyre with the breakdown set and inflate it ⇒ Breakdown set . Seek expert assistance for this if necessary.

☒ Check and adjust the tyre pressure.

☒ Go to a qualified workshop. Volkswagen recommends using a Volkswagen dealership for this purpose.

Tyre wear

Fast cornering, heavy acceleration and hard braking all increase tyre wear.

Wheel imbalance may develop when the vehicle is driven; you will notice this by nervous steering response. Unbalanced wheels will affect the level of tyre wear. In this case, the wheels should be balanced again.

Incorrect wheel alignment impairs driving safety and increases tyre wear. The running gear should be checked by a qualified workshop if tyres show excessive wear.

WARNING

If you notice unusual vibration or the car pulling to one side while the vehicle is in motion, this may indicate that one of the tyres is damaged.

- ☐ Reduce speed immediately and park the vehicle without obstructing traffic.
- ☐ Check the tyres and wheel rims for damage.
- ☐ Never drive on if tyres or wheel rims are damaged. Seek expert assistance instead.
- ☐ If there is no visible damage, drive slowly and cautiously to the next qualified workshop in order to have the vehicle checked.

Spare wheel or temporary spare wheel

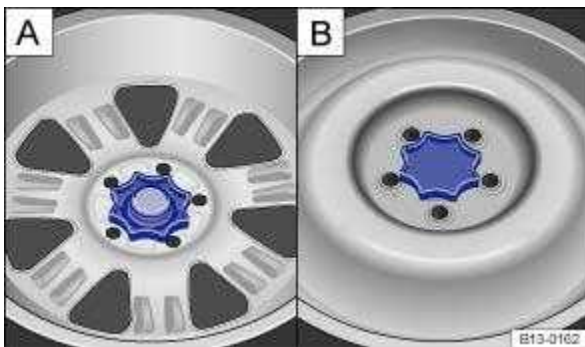

Fig. 197 In luggage compartment: : handwheel for securing spare wheel, : handwheel for securing temporary spare wheel.



First read and observe the introductory information and safety warnings ⇒  Introduction

Removing the spare wheel/collapsible spare wheel/temporary spare wheel

- ☐ Open the boot lid.
- ☐ Fold up or remove the luggage compartment floor ⇒ Luggage compartment floor .
- ☐ If necessary, lift up the floor covering and remove.
- ☐ Remove the vehicle toolkit with the container.
- ☐ Fully unscrew the handwheel in middle of the spare wheel ⇒ Fig. 197 in an anti-clockwise direction.
- ☐ Remove the spare wheel/collapsible spare wheel/temporary spare wheel.

Stowing the replaced wheel

- 🔍 Open the boot lid.
- 🔍 Fold up or remove the luggage compartment floor ⇒ Luggage compartment floor .
- 🔍 If necessary, lift up the floor covering and remove.
- 🔍 Place the removed wheel into the spare wheel well with the rim facing downwards so that the centre hole in the rim is positioned exactly above the hole or threaded pin.
- 🔍 Screw the handwheel clockwise onto the threaded pin until the replaced wheel is firmly secured.
- 🔍 Return the vehicle tools to the container and stow the container in the luggage compartment.
- 🔍 Place the floor covering in the luggage compartment if necessary.
- 🔍 Replace the luggage compartment floor ⇒ Luggage compartment floor .
- 🔍 Close the boot lid.

If the spare wheel tyre is not the same as the tyres on the vehicle

If the spare wheel tyre differs from the other tyres on the vehicle, the spare wheel must be used only in the event of a tyre failure and for a short time ⇒ ⚠️ .

Observe these driving notes:

- 🔍 Do not drive faster than 80 km/h (50 mph).
- 🔍 Avoid full acceleration, hard braking and fast cornering.
- 🔍 Do not use snow chains on the temporary spare wheel ⇒ Snow chains .
- 🔍 The tyre pressure must be checked as soon as possible after fitting the spare wheel or temporary spare wheel ⇒ Tyre pressure .

WARNING

Incorrect use of the spare wheel or temporary spare wheel can lead to a loss of control over the vehicle, collisions or other accidents and cause serious injuries.

- 🔍 Never use a spare wheel or temporary spare wheel if it is damaged or worn down to the tread wear indicators.
- 🔍 Some vehicles may be equipped with a temporary spare wheel instead of a spare wheel. The temporary spare wheel can be recognised by a sticker and the text 80 km/h or 50 mph. This is the maximum speed at which you are permitted to drive with this tyre. The sticker must not be covered during use of the wheel.
- 🔍 Never drive faster than 80 km/h (50 mph). Do not accelerate quickly, brake suddenly or drive at high speed through bends.
- 🔍 Never drive further than 200 km with a temporary spare wheel if it is fitted to the drive axle.

- ☒ The temporary spare wheel should be exchanged for a normal wheel as soon as possible. The temporary spare wheel is designed for a short period of use only.
- ☒ The temporary spare wheel must always be secured with the factory-supplied wheel bolts.
- ☒ Never drive using more than one spare wheel that differs from the normal tyres.
- ☒ After fitting the temporary spare wheel, the tyre pressure must be checked as soon as possible ⇒ Tyre pressure .
- ☒ Snow chains must not be used on the temporary spare wheel.
- ☒ Do not fit a temporary spare wheel to the rear axle when towing a trailer ⇒ .

Tyre lettering and tyre type

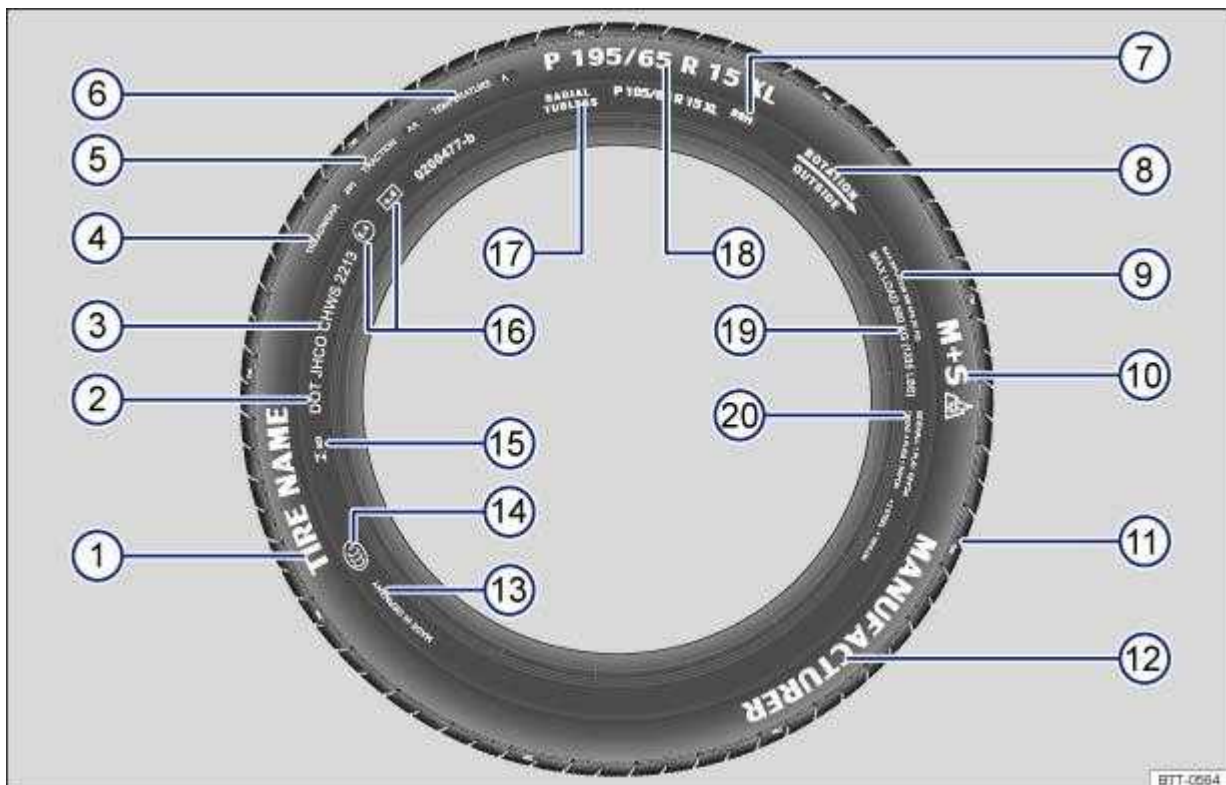





Fig. 198 International tyre lettering.



First read and observe the introductory information and safety warnings ⇒ Introduction

⇒ Fig. 198	Tyre lettering (example)	Meaning
①	Product name	Individual tyre designation of the manufacturer.
②	DOT	The tyre complies with the legal requirements of the USA Department of Transportation, responsible for tyre safety standards.
③	JHCO CHWS 2213	Tyre identification number (TIN _a) – may be only on the inner side of the wheel) and date of

⇒ Fig. 198	Tyre lettering (example)	Meaning	
		manufacture:	
		JHCO CHWS	Identifier of producing plant and specifications of the tyre manufacturer for size and characteristics.
		2213	Manufacturing date: 22nd week in 2013.
Information for the end user concerning comparative values for specified basic tyres (standardised test procedure) ⇒ Customer information :			
④	TREADWEAR 280	Relative life expectancy for the tyre, with reference to a US-specific standard test. Tyres with the specification 280 wear 2.8 times more slowly than standard tyres which have a treadwear value of 100. The performance of tyres is determined by how they are used and can deviate significantly from standard values due to driving style, maintenance, road surface and climatic conditions.	
⑤	TRACTION AA	Wet braking response of the tyre (AA, A, B or C). The wet braking response is tested under controlled conditions on certified test tracks. Tyres marked C have a low traction performance. The traction value assigned to the tyres is based on linear traction tests and does not include acceleration, lateral stability, aquaplaning or traction under maximum load.	
⑥	TEMPERATURE A	Temperature stability of the tyre at higher test bench speeds (A, B or C). A and B tyres exceed legal requirements. The temperature evaluation is based on tyres with correct pressure and does not allow for excess pressure. Excessive speed, incorrect pressure or excess pressure can cause heat build-up or tyre damage. This applies to one or a combination of these factors.	
⑦	88 H	Load index ⇒ Tyre load and speed index ⇒ Speed index .	
⑧	Rotation and arrow	Denotes direction of rotation of the tyres ⇒ Tyres	

⇒ Fig. 198	Tyre lettering (example)	Meaning	
		with directional tread pattern .	
	OR: Outside	Denotes outside of tyres ⇒ Asymmetrical tyres .	
⑨	MAX INFLATION 350 KPA (51 psi/3.51 bar)	US limitation for the maximum air pressure.	
⑩	M+S or M/S or 	Denotes winter tyres (mud and snow tyres) ⇒ Winter tyres . Studded tyres are labelled with an E after the S.	
⑪	TWI	Indicates the position of the tread wear indicator ⇒ Tread depth and wear indicators .	
⑫	Brand name, logo	Manufacturer.	
⑬	Made in Germany	Country of manufacture.	
⑭		Country-specific identification for China (China Compulsory Certification).	
⑮	 023	Country-specific identification for Brazil.	
⑯	E4 e4 0200477-b	Identification in accordance with international regulations with the code number of the country that granted approval. Approved tyres which comply with ECE regulations are denoted with E, tyres which comply with EC regulations are denoted with e. This is followed by the multiple-digit approval number.	
⑰	RADIAL TUBELESS	Tubeless radial tyre.	
⑱	P 195 / 65 R 15 XL	Size designation:	
		P	Identification for passenger vehicle.
		195	Tyre width from sidewall to sidewall in mm.
		65	Aspect ratio in %.
		R	Belt type code for radial.

⇒ Fig. 198	Tyre lettering (example)	Meaning	
		15	Rim diameter in inches.
		XL	Heavy-duty tyre (Extra Load).
⑰	MAX LOAD 615 KG (1235 LBS)	US load specification for the maximum load per wheel.	
⑳	SIDEWALL 1 PLY RAYON	Information about the tyre carcass components:	
		1 ply of rayon (artificial silk).	
	TREAD 4 PLYS	Information about the tread components:	
	1 RAYON + 2 STEEL + 1 NYLON	In the example there are 4 plies under the tread surface: 1 ply of rayon (artificial silk), 2 steel belt plies and 1 nylon ply.	

The tyre lettering is located on both sides. Certain labels may only be found on one side of the tyre, e.g. tyre identification number and manufacturing date.

Any additional numbers and letters are internal codes used by the tyre manufacturer or country-specific identifiers.

Low-profile tyres

Low-profile tyres have a wider tread surface, larger rim diameter and lower side walls than conventional wheel/tyre combinations ⇒ . Low-profile tyres can improve the vehicle's handling and precision. They may however result in a less comfortable ride on poor road surfaces and tracks.

Tyres with directional tread pattern

An arrow on the tyre sidewall indicates the direction of rotation on tyres with directional tread pattern. The direction of rotation must be observed in all cases. This guarantees the best possible running characteristics.

If, however, the tyre is fitted in the opposite direction to the tread pattern, you must take more care when driving as the tyre is now no longer being used according to its designation. The tyre must be replaced as quickly as possible or be fitted with the tread in the correct direction.

Asymmetrical tyres

Asymmetrical tyres take into account the differing behaviour of the inner and outer areas of the tread pattern. The sidewalls of asymmetrical tyres are marked to indicate "inside" or "outside". Make sure that you observe the correct tyre positioning on the wheel rim.

Tyre load

The load index indicates how many kilograms can be loaded onto an individual tyre (tyre load).

Examples:

78425 kg81462 kg83487 kg85515 kg87545 kg88560 kg91615 kg92630 kg93650 kg95690 kg97730
kg99775 kg100800 kg101825 kg102850 kg103875 kg104900 kg

Speed index

The speed index indicates the maximum permitted speed that may be driven with the tyres.

Pmax. 150 km/h (93 mph) Qmax. 160 km/h (99 mph) Rmax. 170 km/h (106 mph) Smax. 180 km/h
(112 mph) Tmax. 190 km/h (118 mph) Umax. 200 km/h (125 mph) Hmax. 210 km/h
(130 mph) Vmax. 240 km/h (149 mph) Wmax. 270 km/h (168 mph) Ymax. 300 km/h
(186 mph) Zover 240 km/h (149 mph)

Some tyre manufacturers use the code ZR for tyres with a maximum permitted speed of over 240 km/h (149 mph).

a) The TIN is the tyre serial number.

Maximum load and speed range for tyres



First read and observe the introductory information and safety warnings ⇒  Introduction

Vehicles in the EU and the so-called EU user states are issued an EC Certificate of Conformity. This details the size, diameter, load rating and speed range of all tyres approved by Volkswagen for the relevant vehicle type.

The type plate shows whether there is an EC certificate of conformity for this particular vehicle. The type plate can be seen on the lower part of the door pillar when the driver door is open ⇒ Technical data .

☐ If the type plate has a row marked Permit, this means that the vehicle has an EC certificate of conformity.

☐ If there is no type plate, or if there is no row marked Permit, the vehicle does not have an EC certificate of conformity.

Winter tyres



First read and observe the introductory information and safety warnings ⇒  Introduction

Winter or all-year tyres improve the handling and braking response in winter conditions. Volkswagen recommends that winter tyres be fitted to the vehicle at temperatures below +7°C (+45°F) or in winter conditions.

Winter tyres and all-year tyres lose a large degree of their effectiveness for winter conditions when the tread is worn down to a depth of 4 mm.

The following applies when using winter tyres:

☐ Observe any country-specific legal requirements.

☐ Use winter tyres on all four wheels at the same time.

☐ Use only in winter road conditions.

- ☑ Use only the tyre sizes that have been approved for the vehicle.
- ☑ Use only winter tyres with same belt type, size and same tread pattern.
- ☑ Observe the maximum speed permitted by the speed index ⇒ ⚠.

Speed limitation

Winter tyres have a speed limit depending on the speed index ⇒ Tyre lettering and tyre type .

Speed warning settings can be made and adjusted in the Infotainment system using the **MENU** button and the  and Tyres function buttons.

If you use V-rated winter tyres, the speed limits and required tyre pressure are determined by the engine size. In this case, always ask a Volkswagen dealership about the maximum permitted speed and required tyre pressure.

All-wheel drive (4MOTION)

Thanks to its all-wheel drive, the vehicle has good traction in winter conditions, even with the standard tyres. Nevertheless, Volkswagen still recommends that winter tyres or all-year tyres should be fitted on all four wheels in winter, above all because this will give improved braking efficiency.

Observe information on snow chains⇒ Snow chains .

WARNING

The improved driving characteristics afforded by the winter tyres in winter conditions should not encourage you to take any risks.

- ☑ Adapt your speed and driving style to suit visibility, weather, road and traffic conditions.
- ☑ Never exceed the maximum speed and load permitted for the winter tyres that are fitted.



The vehicle handling is better if summer tyres are fitted at temperatures above +7°C (+45°F). The rolling noise is quieter, the tyre wear lower and the energy efficiency higher in this case.



In vehicles with a Tyre Pressure Loss Indicator, the system has to re-synchronise after wheels are changed ⇒ Tyre monitoring system .



Volkswagen dealerships can provide details on permissible winter tyre sizes.

Snow chains



First read and observe the introductory information and safety warnings⇒ ⚠ Introduction

Volkswagen recommends fitting the snow chains before mounting the wheel on the car.

 **WARNING**

The use of snow chains that are unsuitable for your vehicle or the incorrect installation of snow chains can cause accidents and serious injuries.

- ☐ Always use the correct snow chains.
- ☐ Follow the fitting instructions provided by the snow chain manufacturer.
- ☐ Never exceed the maximum speed permitted for the snow chains that are fitted.

 **NOTICE**

- ☐ Remove the snow chains when driving on roads that are free of snow. The snow chains will otherwise impair handling, damage the tyres and wear out very quickly.
- ☐ Snow chains that are in direct contact with the wheel rim can scratch or damage it. Volkswagen recommends using snow chains with built-in rim protection.



In vehicles with a Tyre Pressure Loss Indicator, the system must be re-synchronised after snow chains are fitted ⇒ Tyre monitoring system .

Hubcaps

Centre wheel trim



Fig. 199 Removing the centre wheel trim by pulling.



Fig. 200 Removing the centre wheel trim by turning.

The centre wheel trim protects the wheel bolts and must be fitted again after changing the wheel.

Vehicles with centre wheel trims that can be removed by pulling

☐ To remove: take the wire hook from the vehicle toolkit ⇒ Vehicle toolkit and insert it into a hole (alloy wheel) or fit it on the edge (steel wheel) of the trim ⇒ Fig. 199 .

☐ Remove the cover in the direction of the arrow.

☐ To fit: press the centre wheel trim against the rim until you feel it engage.

Vehicles with centre wheel trims that can be removed by turning

☐ To remove: turn the centre wheel trim clockwise or anti-clockwise until it is released from the rim ⇒ Fig. 200 .

☐ Reach behind one of the ribs and remove the centre wheel trim.

☐ To fit: place the centre wheel trim centrally on the rim.

☐ Press the centre wheel trim against the rim until you feel it engage.

WARNING

Using unsuitable hubcaps, or fitting them incorrectly, can cause accidents and serious injuries.

☐ Incorrectly fitted hubcaps can become loose while the vehicle is in motion and endanger other road users.

☐ Do not use damaged hubcaps.

☐ Always ensure that the airflow to cool the brakes is not restricted or reduced. This also applies if hubcaps are retrofitted. If the airflow is not sufficient, the braking distance could increase significantly.

Wheel cover

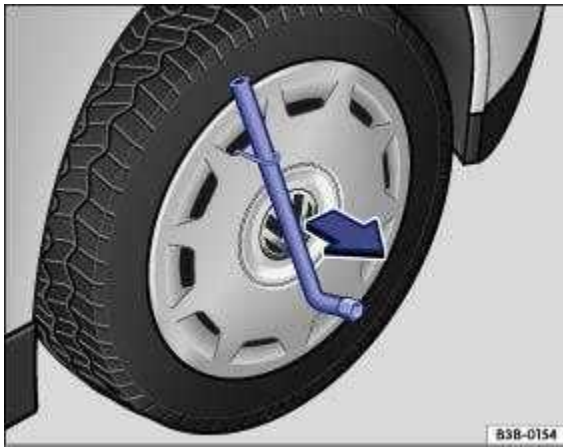

Fig. 201 Removing the wheel cover.

The wheel cover protects the wheel bolts and must be fitted again after changing the wheel.

Removing wheel covers

- ☐ Take the box spanner and wire hook from the vehicle toolkit ⇒ Vehicle toolkit .
- ☐ Insert the wire hook into one of the holes in the wheel cover.
- ☐ Push the box spanner through the wire hook ⇒ Fig. 201 and remove the wheel cover in the direction of the arrow.

Fitting wheel covers

- ☐ Check the correct position of the anti-theft wheel bolt ⇒ Wheel bolts .
- ☐ Press the wheel cover onto the rim so that the valve hole is located over the tyre valve ⇒ Fig. 204① . Please ensure the cover engages securely all the way round.

The wheel cover must engage securely in position around the entire circumference.

WARNING

Using unsuitable hubcaps, or fitting them incorrectly, can cause accidents and serious injuries.

- ☐ Incorrectly fitted hubcaps can become loose while the vehicle is in motion and endanger other road users.
- ☐ Do not use damaged hubcaps.
- ☐ Always ensure that the airflow to cool the brakes is not restricted or reduced. This also applies if hubcaps are retrofitted. If the airflow is not sufficient, the braking distance could increase significantly.

Wheel bolt caps



Fig. 202 Removing the wheel bolt caps.

The caps protect the wheel bolts and should be placed fully back in position after changing the wheel.

Removing and fitting the caps

☒ To remove: take the wire hook from the vehicle toolkit ⇒ Vehicle toolkit .

☒ Insert the hook through the opening in the cap ⇒ Fig. 202 and pull off in the direction of the arrow.

☒ To fit: press the caps on the bolts as far as they will go.

The anti-theft wheel bolt has a separate cap. It only fits onto the anti-theft wheel bolt and not onto conventional wheel bolts.

Changing a wheel



Introduction

This chapter contains information on the following subjects:

⇒ Preparations for changing a wheel

⇒ Wheel bolts

⇒ Lifting the vehicle with the jack

⇒ Changing a wheel

⇒ After changing a wheel

Some models are delivered from the factory without a jack or box spanner. In this case, the wheel should be changed by a qualified workshop.

The vehicle jack supplied with the vehicle is only designed for changing a wheel when one vehicle tyre is damaged and has to be replaced. If both tyres on one side of the vehicle, both tyres on one axle, or all tyres are damaged, seek expert assistance.



WARNING

Changing a wheel can be dangerous, especially when carried out at the side of a road. Please observe the following steps in order to reduce the risk of serious injuries:

- ☐ Stop the vehicle as soon as possible and when safe to do so. Park the vehicle at a safe distance from moving traffic in order to carry out the wheel change.
- ☐ All passengers and children in particular must be at a safe distance and away from your area of work during the wheel change.
- ☐ Switch on the hazard warning lights to warn other road users.
- ☐ Check that the surface the vehicle is parked on is level and firm. If necessary, use a large, sturdy board or similar support for the vehicle jack.
- ☐ Only change the wheel yourself when you feel confident with carrying out the procedure. If not, seek expert assistance.
- ☐ Always use suitable and undamaged tools to change the wheel.
- ☐ Always switch off the engine, switch on the electronic parking brake and move the selector lever to the position P or select a gear on a manual gearbox in order to reduce the risk of unintended vehicle movement.
- ☐ The wheel bolt tightening torque should be checked with a perfectly functioning torque wrench immediately after changing a wheel.
- ☐ In the case of vehicles with a Tyre Pressure Loss Indicator, the system must be re-synchronised immediately after a wheel change ⇒ Tyre Pressure Loss Indicator .

Preparations for changing a wheel



First read and observe the introductory information and safety warnings ⇒ ⚠ Introduction

Checklist

The following actions must always be carried out in the given order in preparation for changing the wheel ⇒ ⚠ :



If your vehicle has a flat tyre, park the vehicle on a firm and level surface at a safe distance from moving traffic.



Switch on the electronic parking brake Parking and manoeuvring.



DSG® dual clutch gearbox: move the selector lever to position P DSG® dual clutch gearbox.



Switch off the engine and remove the key from the ignition.



Manual gearbox: select a gear.



Ask all vehicle occupants to leave the vehicle and stand at a safe distance away from moving traffic.



Switch on the hazard warning lights and set up the warning triangle In an emergency. Observe any legal requirements.



Chock the wheel diagonally opposite the wheel being worked on with a stone, collapsible chocks or another suitable object.



When towing a trailer: unhitch the trailer from the vehicle and park it properly .



Remove any items of luggage from the luggage compartment.



Remove the spare wheel or temporary spare wheel and the vehicle toolkit from the luggage compartment.



Remove the hubcaps Hubcaps.



Ignoring any of the items on this important safety checklist can lead to accidents and severe injuries.

Follow the actions in the checklist and observe the general safety procedures.

Wheel bolts



Fig. 203 Changing a wheel: loosening the wheel bolts.

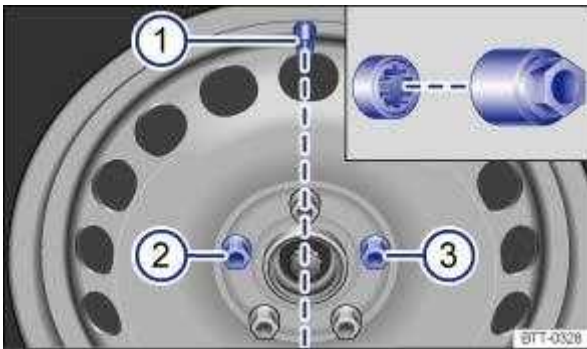

Fig. 204 Changing a wheel: tyre valve ① and locations of the anti-theft wheel bolt ② or ③.



First read and observe the introductory information and safety warnings ⇒ ⚠ Introduction

Use a suitable box spanner to loosen the wheel bolts.

Slacken the wheel bolts only by approximately one turn before raising the vehicle with the vehicle jack.

If a wheel bolt is very tight, you may be able to loosen it by pushing down the end of the spanner carefully with your foot. Hold on to the car for support and take care not to slip.

Loosening the wheel bolts

☑ Fit the box spanner over the wheel bolt as far as it will go ⇒ Fig. 203 .

☑ Hold the end of the box spanner and turn the wheel bolt one turn anti-clockwise ⇒ ⚠ .

Loosening the anti-theft wheel bolt

☑ Take the adapter for the anti-theft wheel bolt out of the vehicle toolkit.

☑ Insert the adapter into the anti-theft wheel bolt as far as it will go.

☑ Push the box spanner onto the adapter as far as it will go.

☑ Hold the end of the box spanner and turn the wheel bolt one turn anti-clockwise ⇒ ⚠ .

Screwing in the anti-theft wheel bolt (wheel cover)

On wheels with a wheel cover, the anti-theft wheel bolt must be screwed into position ⇒ Fig. 204 ② or ③ according to the position of the tyre valve ①. The wheel cover can otherwise not be fitted.

Tightening torque of wheel bolts

Specified tightening torque for wheel bolts for steel or alloy wheels:

☑ 140 Nm

If the wheel bolts are corroded and difficult to turn, they must be replaced before the tightening torque is checked and the wheel hub threads cleaned.

Never grease or oil the wheel bolts or the threads of the wheel hub.

The tightening torque should be checked with a properly functioning torque wrench immediately after changing a wheel.

 **WARNING**

Incorrectly tightened wheel bolts can loosen while the vehicle is in motion and cause accidents, serious injury, and loss of control of the vehicle.

☑ The wheel bolts and threads of the wheel hubs must be clean, free from oil and grease, and turn easily.

☑ Always use the box spanner placed in the vehicle at the factory to loosen and tighten the wheel bolts.

☑ Slacken the wheel bolts only by approximately one turn before raising the vehicle with the vehicle jack.

☑ Never grease or oil the wheel bolts or the threads of the wheel hub. This could cause them to loosen while the vehicle is in motion, even if they have been tightened with the specified tightening torque.

☑ Never loosen the bolted connections on wheel rims with bolted-on rings.

☑ If the tightening torque of the wheel bolts is too low, the wheel bolts and rims can become loose while the vehicle is in motion. The wheel bolts and the threads could be damaged if the tightening torque is too high. Check the tightening torque regularly using a torque wrench.

 **WARNING**

The wrong wheel bolts can loosen while the vehicle is in motion and cause accidents, serious injury, and loss of control of the vehicle.

☑ Use only wheel bolts that belong to the respective wheel rim.

☑ Never use different wheel bolts.

☐ On vehicles with two-piece wheel bolts: use only two-piece wheel bolts.

Lifting the vehicle with the jack



Fig. 205 Jacking points.

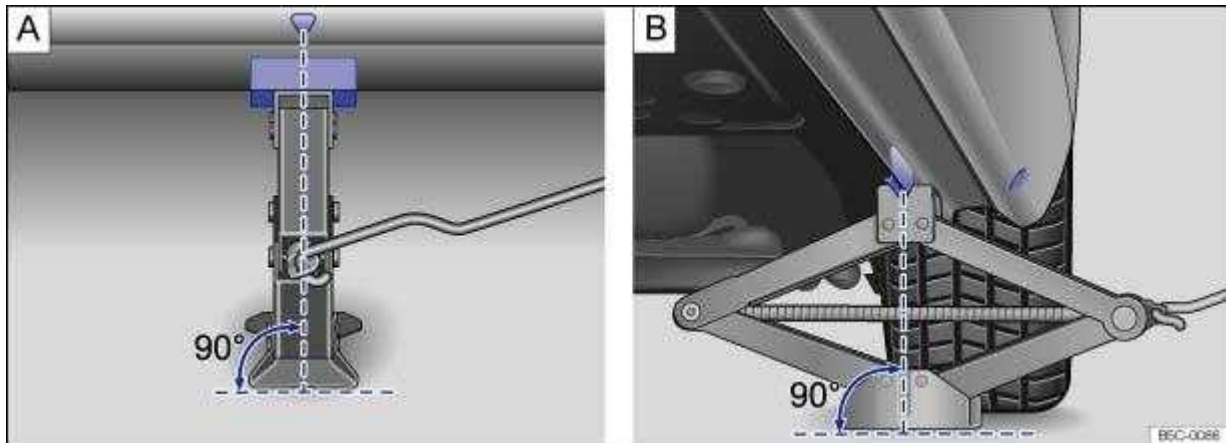

Fig. 206 Jack fitted at the rear on the left-side of the vehicle.



First read and observe the introductory information and safety warnings ⇒ ⚠ Introduction

The jack may be positioned only at the reinforcements on the underbody, which are located behind the markings on the body ⇒ Fig. 205 . Always use the jacking point closest to the wheel you are working on ⇒ ⚠ .

Checklist

For your own safety, carry out the following points in the specified order ⇒ ⚠ :

☐ ✓

Choose a firm and level surface suitable for lifting the vehicle.

☐ ✓

Switch off the engine. Select a gear on vehicles with a manual gearbox or move the selector lever to position P on vehicles with DSG® dual clutch gearbox DSG® dual clutch gearbox and switch on the electronic parking brake Parking and manoeuvring.

☐ ✓

Chock the wheel diagonally opposite using collapsible chocks or other suitable objects.

☐ ✓

When towing a trailer : unhitch the trailer from the vehicle and park it properly.



Loosen the wheel bolts Wheel bolts.



Find the jacking point under the vehicle which is closest to the wheel that is being changed.



Insert the crank into the opening on the jack (depends on the vehicle equipment).



Crank up the jack until it just fits under the jacking point of the vehicle.



Ensure that the entire surface of the foot of the jack is resting securely on the floor, and that the foot of the jack is positioned fully underneath the point of application and .



Position the jack and simultaneously continue to crank the claw up until it is in position around the vertical rib underneath the vehicle .



Crank the jack further until the wheel is just clear of the ground.

WARNING

Incorrect use of the vehicle jack could cause the vehicle to slip off the jack. This could lead to severe injuries. Observe the following points in order to reduce the risk of injuries:

Use only vehicle jacks that have been approved by Volkswagen for your vehicle type. Other vehicle jacks could slip out of position – this includes vehicle jacks supplied with other Volkswagen models.

The ground must be flat and firm. Soft ground or surfaces at an incline under the jack may cause the vehicle to slip off the jack. If necessary, use a large, sturdy board or similar support for the vehicle jack.

On a slippery surface, e.g. tiles, use a rubber mat or similar to prevent the jack from slipping.

Fit the jack only at the points described. The vehicle jack claw must grip the vertical rib under the side member securely ⇒ Fig. 206 .

Never place any part of your body (e.g. an arm or leg) underneath the vehicle if the latter is supported only by the vehicle jack.

- ☒ If you have to work underneath the vehicle, use suitable stands to provide extra support for the vehicle.
- ☒ Never raise the vehicle when the engine is running, or if the vehicle is tilted to one side or on a gradient.
- ☒ Never start the engine when the vehicle is raised on a jack. The vibration of the engine could cause the vehicle to fall off the vehicle jack.

 **WARNING**

Ignoring any of the items on this important safety checklist can lead to accidents and severe injuries.

- ☒ Follow the actions in the checklist and observe the general safety procedures.

Changing a wheel



Fig. 207 Changing a wheel: removing the wheel bolts with the screwdriver handle.

 First read and observe the introductory information and safety warnings ⇒  Introduction

Removing a wheel

- ☒ Observe the checklist ⇒ Preparations for changing a wheel .
- ☒ Loosen the wheel bolts ⇒ Wheel bolts .
- ☒ Jack up the vehicle ⇒ Lifting the vehicle with the jack .
- ☒ Using the hexagon socket in the screwdriver handle ⇒ Fig. 207 , completely unscrew the loosened wheel bolts and place them on a clean surface.
- ☒ Remove the wheel.

Fitting the spare wheel or temporary spare wheel

- ☒ Pay attention to the tyre direction of rotation ⇒ Tyre lettering and tyre type .
- ☒ Put the wheel in place.

- ☐ Screw in the anti-theft wheel bolt using the adapter at position ⇒ Fig. 204 ② or ③ and tighten it slightly in a clockwise direction.
- ☐ Screw in all the other wheel bolts in clockwise direction and tighten them slightly.
- ☐ Lower the vehicle with the jack.
- ☐ Use the box spanner to tighten all the wheel bolts securely in clockwise direction ⇒ ⚠. Do not tighten the bolts in order but always in diagonally opposite sequence.
- ☐ Fit the caps, wheel centre trim or wheel cover ⇒ Hubcaps .

WARNING

Incorrect tightening torque or incorrect use of wheel bolts can lead to a loss of control of the vehicle, and cause accidents and serious injuries.

- ☐ Always keep all wheel bolts and threads in the wheel hubs clean and free from oil and grease. The wheel bolts must be easy to turn and be tightened to the specified torque.
- ☐ The hexagon socket in the screwdriver handle should be used only for turning wheel bolts, not use for loosening or tightening them.

After changing a wheel

 First read and observe the introductory information and safety warnings ⇒ ⚠ Introduction

- ☐ Clean the tools from the vehicle toolkit and place them back in the foam rubber holder in the luggage compartment ⇒ Vehicle toolkit .
- ☐ Stow the changed wheel away securely in the luggage compartment.
- ☐ Have the tightening torque of the wheel bolts checked immediately ⇒ Tightening torque of wheel bolts .
- ☐ The damaged wheel should be replaced as soon as possible.



After changing a wheel, the indicator lamp for the tyre monitoring system may indicate a fault in the system ⇒ Troubleshooting for Tyre Pressure Loss Indicator .

Breakdown set

 Introduction

This chapter contains information on the following subjects:

- ⇒ Contents of the breakdown set
- ⇒ Preparations
- ⇒ Sealing and inflating tyres

⇒ Check after driving for 10 minutes

The breakdown set can be used to temporarily and reliably seal any tyre damage caused by foreign bodies or punctures (up to approx. 4 mm in diameter). Do not remove foreign objects (e.g. screws or nails) from the tyre!

Once the sealant has been added to the tyre, the tyre pressure must be checked and adjusted again after approximately 10 minutes of driving.

Seek expert assistance if more than one of the vehicle's tyres is damaged. The breakdown set is designed to fill only one tyre.

Only use the breakdown set when the vehicle has been safely parked and you are familiar with the work and safety precautions needed. Seek expert assistance if this is not the case.

The tyre sealant must not be used:

- ☒ If the wheel rim is damaged.
- ☒ If the outside temperature is below -20°C (-4°F).
- ☒ If there are cuts or punctures in the tyre that are larger than 4 mm.
- ☒ If the vehicle was driven with very low tyre pressure or a flat tyre.
- ☒ If the use-by date on the tyre filler bottle has expired.
- ☒ If a foreign object has been removed from the tyre.

WARNING

Using the breakdown set can be dangerous, especially if the tyre is inflated at the roadside. Please observe the following steps in order to reduce the risk of serious injuries:

- ☒ Stop the vehicle as soon as possible and when safe to do so. Park the vehicle at a safe distance from moving traffic in order to fill the tyre.
- ☒ Check that the surface the vehicle is parked on is level and firm.
- ☒ All passengers, and children in particular, must be at a safe distance and away from your area of work.
- ☒ Switch on the hazard warning lights to warn other road users.
- ☒ The breakdown set should be used only if you feel confident with carrying out the procedure. If not, seek expert assistance.
- ☒ The breakdown set is intended for emergency use only so that you can reach the nearest qualified workshop.
- ☒ A tyre that has been repaired using the breakdown set must be replaced as soon as possible.
- ☒ Sealant is hazardous to health and must be washed off immediately if it gets onto the skin.

- ☒ Store the breakdown set out of the reach of children.
- ☒ Never use a vehicle jack, even if it is approved for the vehicle.
- ☒ Always switch off the engine, switch on the electronic parking brake and move the selector lever to the position P or select a gear on a manual gearbox in order to reduce the risk of unintended vehicle movement.

 **WARNING**

Tyres that have been filled with sealant will not handle in the same way as a standard tyre.

- ☒ Never drive faster than 80 km/h (50 mph).
- ☒ Avoid full acceleration, sudden braking and fast cornering.
- ☒ Drive for just 10 minutes at no more than 80 km/h (50 mph) and then check the tyre.



Dispose of used or out-of-date sealant in accordance with legal requirements.



A new tyre filler bottle can be obtained from a Volkswagen dealership.



Observe the separate instructions from the manufacturer of the breakdown set.

Contents of the breakdown set

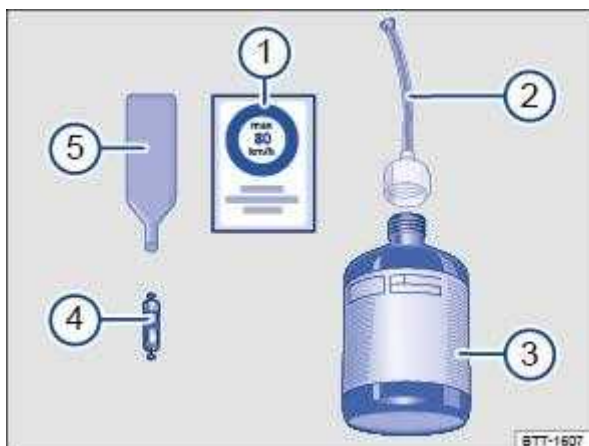

Fig. 208 Illustration: components in the breakdown set

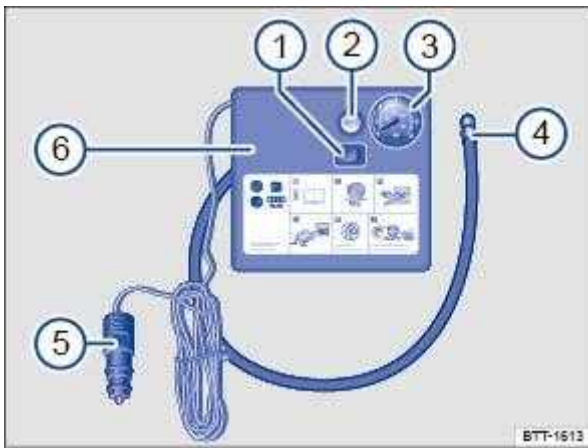

Fig. 209 Illustration: compressor from the breakdown set.



First read and observe the introductory information and safety warnings ⇒ ⚠ Introduction

The breakdown set is located underneath the floor covering in the luggage compartment.

The breakdown set consists of the following components ⇒ Fig. 208 :

- ① Sticker with the maximum permitted speed max. 80 km/h or max. 50 mph
- ② Filler hose with plug
- ③ Tyre filler bottle
- ④ Spare valve core
- ⑤ Valve core extractor

The compressor in the breakdown set consists of the following components ⇒ Fig. 209 :

- ① On/off switch
- ② Air bleed screw
- ③ Tyre pressure display
- ④ Tyre filler hose
- ⑤ 12-volt plug
- ⑥ Air compressor

There is a slot on the lower end of the valve core extractor ⇒ Fig. 208 ⑤ for the valve core. This is required for extracting the valve core from the tyre valve and then screwing it back in. This also applies to the spare valve core ④.



The air compressor from the breakdown set may be operated from the 12-volt socket, even if the power rating on the type plate of the air compressor exceeds the maximum power rating of the socket.

Preparations



First read and observe the introductory information and safety warnings ⇒ ⚠ Introduction

Checklist

Always carry out the following actions in the given order ⇒ ⚠ :



If your vehicle has a flat tyre, park the vehicle on a firm and level surface at a safe distance from moving traffic.



Switch on the electronic parking brake Parking and manoeuvring.



DSG® dual clutch gearbox: move the selector lever to position P DSG® dual clutch gearbox.



Switch off the engine and remove the key from the ignition.



Manual gearbox: select a gear Manual gearbox: selecting a gear.



Ask all vehicle occupants to leave the vehicle and stand at a safe distance away from moving traffic.



Switch on the hazard warning lights and set up the warning triangle In an emergency. Observe any legal requirements.



Check whether the puncture can be repaired with the breakdown set The tyre sealant must not be used:.



When towing a trailer: unhitch the trailer from the vehicle and park it properly .



Remove any items of luggage from the luggage compartment.



Take the breakdown set out of the luggage compartment.



Take the sticker ① from the breakdown set and stick it on the dash panel within the driver's field of vision.



Do not remove foreign objects (e.g. screws or nails) from the tyre.

WARNING

Ignoring any of the items on this important safety checklist can lead to accidents and severe injuries.

 Follow the actions in the checklist and observe the general safety procedures.

Sealing and inflating tyres





First read and observe the introductory information and safety warnings ⇒  Introduction

Sealing a tyre

 Unscrew the cap from the tyre valve.

 Use the valve core extractor ⇒ Fig. 208⑤ to unscrew the valve core from the tyre valve. Place the core on a clean surface.

 Shake the tyre filler bottle ⇒ Fig. 208③ vigorously to and fro several times.

 Screw the filler hose ⇒ Fig. 208② tightly onto the tyre filler bottle in a clockwise direction. The plastic foil on the closure is pierced automatically.

 Remove the plug from the filler hose ⇒ Fig. 208② and place the open end fully on the tyre valve.

 Hold the bottle upside down and fill the entire contents of the tyre filler bottle into the tyre.

 Remove the empty tyre filler bottle from the valve.

 Use the valve core extractor ⇒ Fig. 208⑤ to screw the valve core back into the tyre valve.

Inflating the tyre

 Screw the tyre filler hose ⇒ Fig. 209④ of the air compressor tightly onto the tyre valve.

 Check that the bleed screw ⇒ Fig. 209② is closed.

 Start the engine and let it run.

 Insert the 12-volt plug ⇒ Fig. 209⑤ into one of the vehicle's 12-volt sockets ⇒ Electrical sockets .

- ☒ Use the on/off switch ⇒ Fig. 209① to switch on the air compressor.
- ☒ Run the air compressor until the tyre pressure has reached 2.0 – 2.5 bar (29 – 36 psi/200 – 250 kPa) ⇒ ⚠ . Maximum running time: 8 minutes ⇒ ⚠ .
- ☒ Switch off the air compressor.
- ☒ If a pressure of 2.0 – 2.5 bar (29 – 36 psi/200 – 250 kPa) cannot be achieved, unscrew the tyre filler hose from the tyre valve.
- ☒ Drive the vehicle approximately 10 metres forward or back so that the sealing compound is evenly distributed in the tyre.
- ☒ Screw the tyre filler hose of the air compressor firmly back onto the tyre valve and inflate the tyre again.
- ☒ If the required pressure still cannot be reached, the tyre is too badly damaged. The tyre cannot be sealed with the breakdown set. Do not drive on. Seek expert assistance ⇒ ⚠ .
- ☒ Disconnect the air compressor and unscrew the tyre filler hose from the tyre valve.
- ☒ Drive the vehicle no faster than 80 km/h (50 mph) if a tyre pressure of 2.0 – 2.5 bar (29 – 36 psi/200 – 250 kPa) has been reached.
- ☒ Check the tyre pressure after driving for 10 minutes ⇒ Check after driving for 10 minutes .

WARNING

The tyre filler hose and the air compressor can get hot during inflation.

- ☒ Protect your hands and skin from the hot components.
- ☒ Do not place the hot tyre filler hose or the hot air compressor on any inflammable materials.
- ☒ Allow the device to cool down fully before stowing.
- ☒ If the tyre will not inflate to at least 2.0 bar (29 psi/200 kPa), the tyre is too damaged. The sealant is unable to seal the tyre. Do not drive on. Seek expert assistance.

NOTICE

Switch the air compressor off after a maximum of 8 minutes to avoid overheating. Let the air compressor cool down for a few minutes before switching it back on.

Check after driving for 10 minutes

 First read and observe the introductory information and safety warnings ⇒ ⚠ Introduction

Reconnect the tyre filler hose ⇒ Fig. 209④ and read off the tyre pressure on the tyre pressure display ③.

1.3 bar (19 psi/130 kPa) and lower:

ⓘ Do not drive on! The tyre cannot be sealed adequately with the breakdown set.

ⓘ Seek expert assistance ⇒ ⚠ .

1.4 bar (20 psi/140 kPa) and higher:

ⓘ Adjust the tyre pressure back to the correct value ⇒ Useful information about wheels and tyres .

ⓘ Resume your journey to the nearest qualified workshop. Do not exceed a maximum speed of 80 km/h (50 mph).

ⓘ The damaged tyre should be replaced at the qualified workshop.

WARNING

Driving with a tyre that cannot be sealed is dangerous and can cause accidents and serious injuries.

ⓘ Do not carry on driving if the tyre pressure is 1.3 bar (19 psi/130 kPa) or lower.

ⓘ Seek expert assistance.

Maintenance

Service

Service work and digital service schedule

The vehicle data attached to the inside cover of this owner's manual help ensure that you can have the correct Volkswagen Genuine Parts® installed in your vehicle whenever required. It also determines which type of service applies to your vehicle.

The vehicle data sticker confirms when the vehicle was first registered or delivered, when the pre-delivery inspection was carried out, and thus the date from which your vehicle is covered by our warranty.

Storing the service operations performed (digital service schedule)

Each service record is stored by your Volkswagen dealership and qualified workshop in a central system. This transparent documentation of the service history allows the service operations performed to be reproduced at any time. Each time you have your vehicle serviced, Volkswagen recommends asking for a printed service record, which contains all service work stored in the system.

With every service, the printout of the previous service record is replaced by a current printout.

The digital service schedule is not available in some markets. In this case, your Volkswagen dealership will inform you about the documentation process for service work.

Service work

The following information is documented in the digital service schedule by your Volkswagen dealership or qualified workshop:

ⓘ Which service was carried out and when.

- ☐ Whether any repairs are recommended, such as replacement of the brake pads in the near future.
- ☐ Whether you had any special requests before or during the maintenance work. Your service advisor will note these on the order.
- ☐ Which components or service fluids were changed.
- ☐ When your next service is scheduled for.

The LongLife mobility guarantee is valid until the next inspection is due. Documentation takes place at every due inspection.

The type and scope of service work may differ from vehicle to vehicle. Information on specific work for your vehicle can be requested from a qualified workshop.

 **WARNING**

Inadequate servicing, no servicing at all, or failure to adhere to service intervals can result in breakdowns, accidents and serious injury.

- ☐ Have service work carried out by an authorised Volkswagen dealership or workshop.

 **NOTICE**

Volkswagen is not responsible for any vehicle damage caused by inadequate service work or the lack of part availability.



Regular servicing of your vehicle not only maintains its value, it also ensures that your vehicle remains roadworthy and in working order. You should therefore have your vehicle serviced according to the Volkswagen guidelines.

Fixed service or flexible service

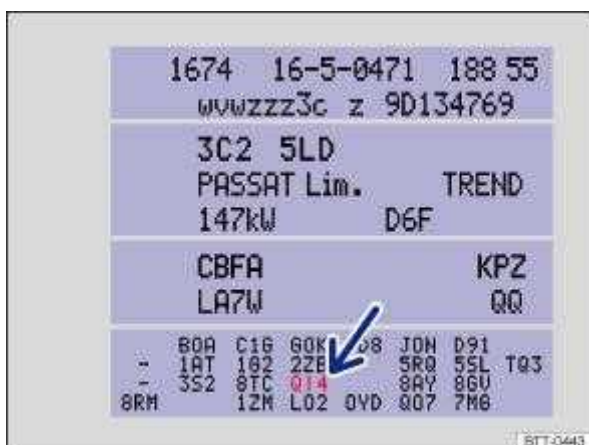

Fig. 210 Vehicle data sticker with PR number for the relevant service (illustration).

The service events differ according to oil change service and inspection. The service interval display in the display of the instrument cluster serves as a reminder for the due date of the next service event.

Your vehicle will receive either the fixed service or flexible service for the oil change service, depending on the vehicle equipment, the engine type and the operating conditions.

How do I know which type of service my vehicle needs?

☒ From the PR number on the vehicle data sticker ⇒ Fig. 210 (arrow) ⇒ Technical data .

☒ From the table below.

Observe the information on engine oil specifications according to VW standards ⇒ Engine oil .

Features of the flexible service

With the flexible service, you only need to have an oil change service carried out if your vehicle requires one. Individual operating conditions and personal driving style are taken into account in order to determine this point in time. An important part of the flexible service is the use of LongLife engine oil instead of conventional oil.

Observe the information on engine oil specifications according to VW standards ⇒ Engine oil .

If you do not wish to have the flexible service, you can opt for the fixed service instead. However, a fixed service can affect your service costs. Your service advisor will be pleased to help.

Service interval display

Scheduled services at Volkswagen are displayed in the service interval display in the instrument cluster ⇒ Service interval display or in the Vehicle settings menu in the Infotainment system ⇒ Vehicle settings menu . This service interval display provides information on services that include an oil change or inspection. When an individual service is due, additional work that is due can also be carried out, e.g. changing brake fluid and spark plugs.

a) Information is stated for vehicles used under normal operating conditions.

b) Whichever comes first.

Information on operating conditions

The specified service intervals and scope of service are always for vehicles used under normal operating conditions.

If the vehicle is operated under severe conditions, some work will have to be performed before the next service or at shorter intervals than those specified.

Severe operating conditions are, for example:

- ☒ Fuels containing sulphur,
- ☒ Regular short trips,
- ☒ Long periods of engine idling (taxis for example),
- ☒ Operation in areas with high levels of dust,
- ☒ Frequent trailer towing (depending on vehicle equipment level),
- ☒ A high percentage of stop and go traffic, e.g. in urban driving, and
- ☒ Driving mainly in winter conditions.

This applies particularly to the following components (according to equipment):

- ☒ Dust and pollen filter
- ☒ Air Care allergen filter
- ☒ Air filter
- ☒ Toothed belt
- ☒ Particulate filter
- ☒ Engine oil

The service advisor at your qualified workshop will be pleased to advise you on whether your vehicle requires more frequent work between the normal service intervals due to the conditions under which it is used.

WARNING

Inadequate servicing, no servicing at all, or failure to adhere to service intervals may result in breakdowns, accidents or serious injury.

- ☒ Have service work carried out by an authorised Volkswagen dealership or workshop.

NOTICE

Volkswagen is not responsible for any vehicle damage caused by inadequate service work or the lack of part availability.

Scope of service

The scope of service includes all maintenance work that is necessary in order to keep your vehicle roadworthy (depending on the operating conditions and vehicle equipment, e.g. engine, gearbox or service fluids). The maintenance work is divided into inspection work and servicing work. You can find out what work is required in detail for your vehicle:

- ☐ From your Volkswagen dealership.
- ☐ From your qualified workshop.
- ☐ In the electronic repair and workshop information system erWin at <https://erwin.volkswagen.de>.

Inspection work

Electrics

- ☐ 12-volt vehicle battery: check and replace if necessary.
- ☐ Lighting: check.
- ☐ Horn: check.
- ☐ Headlight setting: check.
- ☐ Service interval display: reset.

Engine/gearbox

- ☐ Exhaust system: check.
- ☐ Gearbox and final drive: check.
- ☐ Gas system: check.
- ☐ Poly V-belt: check.
- ☐ Cooling system: check.
- ☐ Engine and components in engine compartment: check.
- ☐ Engine oil level: check.

Running gear

- ☐ Swivel joints/track rods: check.
- ☐ Tyres: check.
- ☐ Brake system: check.
- ☐ Brake pads/discs: check.
- ☐ Brake fluid level: check.
- ☐ Boots: check.
- ☐ Coupling rod and stabiliser bearings: check.

- ☐ Pneumatic suspension: check.
- ☐ Breakdown set: check.
- ☐ Tyre pressure on all wheels: check.
- ☐ Power steering: check.
- ☐ Shock absorbers/coil springs: check.

Body

- ☐ Roof systems: check.
- ☐ Windscreen: check.
- ☐ Body: check for corrosion.
- ☐ Wiper blades: check.
- ☐ Window wiper and washer system: check.
- ☐ Door arresters: lubricate.
- ☐ Underbody: check.
- ☐ Water drains: check.
- ☐ Road test: perform.

Servicing work

In addition to the inspection work (depending on the operating conditions and vehicle equipment, e.g. engine, gearbox or service fluids), further servicing work must be performed on your vehicle. The work is dependent on either time and/or mileage.

- ☐ Additives: change/top up.
- ☐ Brake fluid: change.
- ☐ Particulate filter: check.
- ☐ Natural gas tank and lines: change.
- ☐ Gearbox: change oil/filter.
- ☐ Gearbox mountings: change.
- ☐ Gas system filter: change.
- ☐ Final drive/differential: change oil.
- ☐ Diesel fuel filter: change/drain.
- ☐ Air filter: change.
- ☐ Engine: change oil/filter.
- ☐ Dust and pollen filter: change.

☒ Air Care allergen filter: change.

☒ Spark plugs: change.

☒ Toothed belt/toothed belt tensioning roller: check/change.

It is also possible to have servicing work carried out in between the scheduled service events
⇒ Fixed service or flexible service .

The scope of service is subject to change for technical reasons (continuous further development of components). Your Volkswagen dealership or qualified workshop always has the latest information about any changes.

Vehicle care

Notes on vehicle care

Regular, expert care helps to maintain your vehicle.

The longer contamination or dirt is left on the surface of vehicle components and upholstery fabrics, the more difficult it can become to clean and treat them. Extended exposure may mean that it is no longer possible to remove contamination or dirt.

Volkswagen recommend using Genuine care products that have been matched to your vehicle.1)
Consult a qualified workshop if you have any specific questions or if vehicle parts are not listed.

 **WARNING**

Incorrect care and cleaning of vehicle components can impair the safety features of the vehicle and cause serious injury.

☒ Vehicle parts must be cleaned according to the manufacturer's instructions.

☒ Always use approved or recommended cleaning products.

☒ Do not use cleaning agents that contain solvents. Solvents can cause irreparable damage to the airbag modules.

☒ Protect your hands and arms against parts with sharp edges, e.g. when cleaning the insides of the wheel housings.

 **WARNING**

If the windows are covered in dirt, condensation, or ice, visibility will be reduced and the risk of accidents and severe injuries will increase. This could impair the safety equipment of the vehicle.

☒ Drive only when you have a clear view through all windows.

☒ Do not treat the windscreen with water-repellent window coating agents. In unfavourable conditions, such coatings can cause increased dazzle.

WARNING

Care products may be toxic and hazardous. Unsuitable care products and incorrect application of care products can cause accidents, severe injuries, burns or poisoning.

- ☒ Store care products only in the closed original container.
- ☒ Observe the manufacturer's instructions.
- ☒ Keep children away from all care products.
- ☒ Use care products only outside or in well-ventilated rooms so that you do not breathe in any toxic vapours.
- ☒ Never use turpentine, engine oil, nail varnish remover or other volatile fluids for vehicle care. These substances are toxic and highly inflammable.

NOTICE

Soiling with aggressive and solvent-based ingredients can cause irreparable damage to the vehicle equipment, even if left for only a short time, e.g. on seat padding or trim parts.

- ☒ Do not let contamination or dirt dry.
- ☒ Have stubborn stains removed by a qualified workshop.

1) Suitable accessories are available from your Volkswagen dealership. Follow the application instructions on the packaging.

Washing the vehicle

Thoroughly wash the underside of the vehicle on a regular basis to remove road salt or sea water residue.

Automatic car washes

Always observe all the car wash operator's specifications, particularly if your vehicle has add-on parts ⇒  .

- ☒ Preferably use car washes without brushes.
- ☒ Preclean the vehicle by rinsing with water
- ☒ The steering column must not lock when driving through automatic car washes ⇒ Information on steering .
- ☒ Always switch off the wipers ⇒ Operating the wiper lever and the rain/light sensor before using the car wash.
- ☒ Fold in the exterior mirrors.
- ☒ Do not use a hot wax washing programme for vehicles with decorative or protective films.

High-pressure cleaner

Follow the manufacturer's instructions for the high-pressure cleaner. Never use rotating nozzles ⇒  .

☒ Use water up to a maximum temperature of +60°C (+140°F) only.

☒ Do not clean windows that are iced over or covered in snow with a high-pressure cleaner.

☒ Move the jet of water evenly so that the nozzle is at least 50 cm away from the side windows and other vehicle components.

☒ Do not apply the water jet to the same point for too long. Instead, leave stubborn dirt to soak.

☒ If possible, do not direct the water jet at rubber seals, e.g. side windows, decorative trim, tyres, rubber hoses, insulation materials or any other sensitive components, e.g. door locks.

☒ Sensors, camera lenses, and decorative and protective films should be sprayed directly only for brief periods of time.

Hand wash

As a rule, a hand wash is a gentle method to clean your vehicle. However, there are also some things to note for this ⇒  .

☒ Soak the dirt using plenty of water before cleaning the vehicle and rinse well afterwards.

☒ Clean the vehicle with a soft sponge, a cleaning glove or a cleaning brush using only light pressure. Start with the roof and work from the top to the bottom.

☒ Thoroughly rinse out the sponge, wash mitt or brush regularly at short intervals.

☒ Clean wheels, sills etc. last and using a second sponge.

Use a shampoo for very stubborn dirt only.

Waxing

Waxing protects the paintwork. At the latest when water no longer clearly forms small drops and runs off the paintwork when the vehicle is clean, reapply the protection to the vehicle using a quality preservative wax.

Even if a preservative wax is applied regularly in the automatic car wash, Volkswagen recommends protecting the vehicle paintwork at least twice a year using Volkswagen Genuine hard wax (- 000 096 317 -).

Polishing

Polishing is only necessary if the paint has lost its shine, and the gloss cannot be brought back by applying wax.

Matt-painted vehicle parts must not be polished in order to avoid producing a shine ⇒  .



After the car has been washed, the brakes may react slowly and the braking distance will be increased as the brake discs and pads will be wet, or possibly iced up in winter.

☒ Dry and de-ice the brakes by performing careful braking manoeuvres. Do not endanger any other road users when doing this.

⚠ NOTICE

Serious vehicle damage can be caused if the vehicle is not washed correctly.

☒ Always follow the manufacturer's instructions.

☒ Do not wash the vehicle in direct sunlight.

☒ Never aim a water jet directly at locks, doors or the boot lid in cold weather. The locks and seals could freeze up.

⚠ NOTICE

Painted parts and surfaces with a matt finish, unpainted plastic parts, headlight lenses and tail light clusters can be damaged if the vehicle is not washed correctly.

☒ Do not use hard or abrasive brushes.

☒ Clean a matt-painted vehicle only in a textile car wash.

☒ Do not treat matt-painted surfaces with hot wax.

☒ Do not polish matt-painted surfaces.



Wash the vehicle only in specially designated washing areas. This prevents any waste water contaminated with oil from entering the sewerage system.

Caring for and cleaning the vehicle exterior

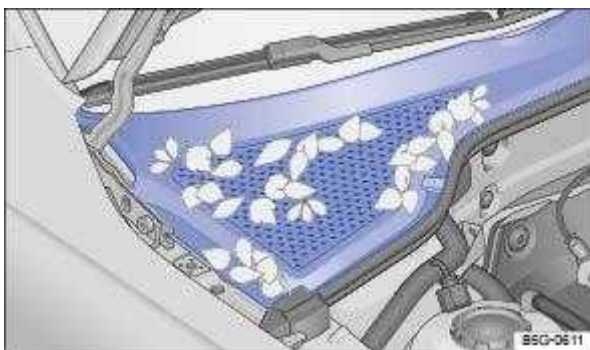

Fig. 211 Between the engine compartment and the windscreen: plenum chamber (illustration).

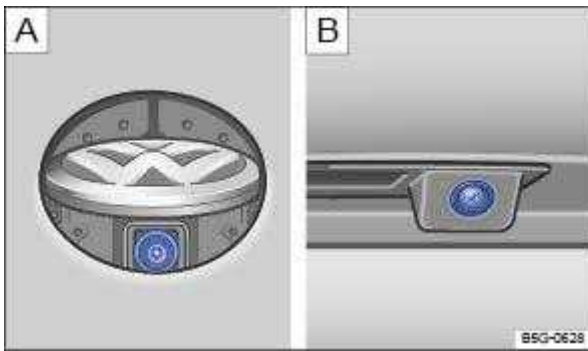



Fig. 212 At the rear of the vehicle: rear view camera system in the Volkswagen badge or in the number plate light (illustration).

The following overview contains recommendations for cleaning and care of individual vehicle components ⇒ .

Windows, glass surfaces:

Remove wax residue, e.g. from care products, using the Volkswagen Genuine cleaning cloth - 000 096 166 A - or a suitable glass cleaner.

Use a hand brush to remove snow and ice. If you use a plastic scraper, move it in one direction only. Use the Volkswagen Genuine de-icing agent (- 000 096 322 -) to remove ice.

Wiper blades: ⇒ Wiper blades .

Paint:

Always treat surfaces carefully in order to prevent damage to the paint coat. Use a clean, soft cloth and a mild soap solution¹⁾ or cleaning clay to remove any light dirt immediately, e.g. deposits, insect residue, or cosmetics.

Repair minor paint damage with a touch-up pen. Refer to the vehicle data sticker for the paint code ⇒ Technical data . Consult a qualified workshop in the event of damage to surfaces with matt paint.

 Overflowing fuel or service fluids: clean immediately.



 Flash rust deposits: moisten deposits with a soap solution. Then remove any deposits with cleaning clay.

 Corrosion: have removed by a qualified workshop.

 Water no longer forms beads on clean paint: preserve paintwork at least twice a year using Volkswagen Genuine hard wax (- 000 096 317 -).

 No gloss in spite of preservation/paint unattractive: treat the vehicle with suitable polish after cleaning to remove dirt and dust.

Plenum chamber, engine compartment:

Remove leaves and other loose objects with a vacuum cleaner or by hand ⇒ Fig. 211 ⇒  . Cleaning of the engine compartment should always be performed by a qualified workshop ⇒  .

Water that has entered the plenum chamber via a manual process (e.g. from a high-pressure cleaner) can cause considerable damage to the vehicle.

Sensors, camera lenses:

clean the area in front of the sensors or camera with a soft cloth and solvent-free cleaning agent. Observe the installation locations ⇒ Vehicle overviews .

☒ Switch on the ignition.

☒ Select selector lever position R.

☒ Clean the camera lens.

Clean sensitive surfaces on the rain/light sensor and the camera window on the windscreen in the same way as windows and glass surfaces (depending on vehicle equipment).

Remove snow with a hand brush. Do not use warm or hot water. Use the Volkswagen Genuine de-icing agent (- 000 096 322 -) to remove ice.

Decorative films, protective films:

Remove soiling as for paint. Always use Volkswagen Genuine plastic cleaner (- 000 096 314 -) for matt decorative films.

Treat the vehicle with liquid hard wax every three months after washing and removing dust. Use only clean, soft microfibre cloths to apply it. Do not use hot wax, even in car washes.

☒ Stubborn dirt: remove carefully using white spirits, and then rinse using warm water.

Trim parts, trim strips, exhaust pipes made of chrome, aluminium or stainless steel:

Clean only using a clean, soft cloth and a mild soap solution²⁾ in a dust-free environment.

Chrome parts can be protected using Volkswagen Genuine hard wax (- 000 096 317 -).

Anodised surfaces: do not use chrome cleaning products.

Headlights, tail light clusters:

Use a soft sponge soaked with a mild soap solution²⁾. Do not use any cleaning agents that contain alcohol or solvents.

☒ Stubborn dirt: remove with Volkswagen Genuine chrome and aluminium care product (- 000 096 319 D -).

Wheels:

Remove dirt and gritting salt deposits with plenty of water.

Alloy wheels: treat dirty aluminium wheels with Volkswagen Genuine wheel rim cleaner (- 000 096 304 -). Volkswagen recommends treating the wheel rims with Volkswagen Genuine hard wax (- 000 096 317 -) every three months.

☒ Damage protective paint coating: repair immediately with a touch-up pen. Go to a qualified workshop if necessary.

☒ Brake dust: use Volkswagen Genuine wheel rim cleaner (- 000 096 304 -).

Door lock cylinders:

Volkswagen recommends using Volkswagen Genuine de-icing agent (- 000 096 322 -) for de-icing. Do not use door lock de-icer containing grease solvents.

 WARNING

The engine compartment of any motor vehicle is a hazardous area. All work in the engine compartment carries the risk of injury, scalding, accidents and fire.

- ☒ Before carrying out any work in the engine compartment, always observe the required procedures and safety precautions ⇒ Safety notes for working in the engine compartment .
- ☒ Volkswagen recommends having the work carried out by a qualified workshop.

 NOTICE

Incorrect cleaning and care can cause vehicle damage.

- ☒ Always follow the manufacturer's instructions.
- ☒ Do not use excessively hard, abrasive cleaning tools.

 NOTICE

The drainage channels for the plenum chamber may get blocked by leaves and dirt. Water that does not drain away could get into the vehicle interior.

- ☒ Have the area under the perforated cover cleaned by a qualified workshop.



The durability and colourfastness of decorative and protective films can be affected by environmental influences such as direct sunlight, moisture, air pollution, stone impact etc. Decorative films may show signs of use or ageing after about one to three years, protective films after about two to three years. In very hot climates, decorative films may start to fade within a year and protective films within two years.

1) null

2) Mild soap solution: a maximum of two tablespoons neutral soap diluted in one litre of water.

Vehicle interior care and cleaning

The following overview contains recommendations for cleaning and care of individual vehicle components ⇒ .

Windows:

Clean with a glass cleaning agent and then wipe dry using a clean chamois cloth or a lint-free cloth.

Textiles, microfibre cloth, leatherette:

Remove any dirt with Volkswagen Genuine interior cleaning agent (- 000 096 301 -). Never treat materials with leather care agents, solvents, wax polish, shoe cream, stain removers or similar substances.

☒ Dirt particles adhering to surfaces: remove with a vacuum cleaner on a regular basis so that the material is not permanently damaged by abrasion.

☒ Grease stains, e.g. oil: use Volkswagen Genuine interior cleaning agent (- 000 096 301 -). Dab off dissolved grease and colour particles with an absorbent cloth and then treat with water if necessary.

☒ Special soiling, e.g. ballpoint pen, nail varnish: use Volkswagen Genuine interior cleaning agent (- 000 096 301 -) and use a mild soap solution¹⁾ if necessary.

Natural leather:

Remove fresh soiling with a cotton cloth and mild soap solution¹⁾. Do not allow fluids to seep into the seams.

Treat any dried stains with Volkswagen Genuine leather cleaner (- 000 096 323 -).

Regularly and each time after having finished cleaning, apply care cream with light protection and impregnating properties. Use a special coloured leather cream if necessary. If the vehicle is parked outdoors for long periods, you should cover the leather to protect it from direct sunlight.

Never treat leather with solvents, wax polish, shoe cream, stain removers or similar.

☒ Grease-based soiling, e.g. oil: remove fresh stains with an absorbent cloth.

☒ Special soiling, e.g. ballpoint pen, nail varnish and dried stains: treat with Volkswagen Genuine leather cleaner (- 000 096 323 -).

Plastic parts:

Use a soft, moist cloth.

If stubborn soiling cannot be removed with mild soap solution¹⁾, use a solvent-free plastic cleaning agent if necessary, e.g. Volkswagen Genuine plastic cleaner (- 000 096 314 -).

Trim parts, trim strips made of chrome, aluminium or stainless steel:

Clean using a clean, soft cloth and a mild soap solution¹⁾ in a dust-free environment.

Anodised surfaces: do not use chrome cleaning products.

Controls:

Remove coarse dirt and other dirt that is difficult to reach using a soft brush. Then use a clean, soft cloth and a mild soap solution¹⁾. Do not allow liquids to enter the controls.

Displays:

Use a Volkswagen Genuine cleaning cloth (- 000 096 166 A -) with a little water, a suitable glass cleaner or LCD cleaner. Do not clean displays with a dry cloth.

Rubber seals:

Clean with a soft, lint-free cloth and plenty of water. Treat with Volkswagen Genuine rubber care agent (- 000 096 310 -) on a regular basis.

Seat belts:

Carefully pull the seat belt right out and leave it out ⇒ ⚠ . Remove coarse dirt with a soft brush. Clean the seat belt with a mild soap solution. Leave the belt fabric to dry completely and then allow it to roll up.

Wooden trims:

Clean with a soft cloth and some mild soap solution¹⁾.

Cleaning upholstery fabrics

If clothing that is not sufficiently colour-fast, e.g. denim, leaves stains on the seat cushion, this is not a defect in the cover fabric. The seat padding may contain components for the airbag system and electrical connections. Seat padding that is damaged, incorrectly cleaned or treated, or that becomes wet, may cause damage to the vehicle electrical system or cause a fault in the airbag system ⇒ ⚠ .

Depending on the equipment, seat cushions with seat heating feature electrical components and connectors that may be damaged in the event of incorrect cleaning or treatment ⇒ ⚠ . This can also result in damage to other parts of the vehicle electrics.

- ❑ Do not use high-pressure cleaners, steam cleaners or cold spray.
- ❑ Do not switch on the seat heating to dry the seats.
- ❑ Do not use washing paste or fine detergent solutions.
- ❑ Avoid soaking in all cases.
- ❑ In the event of uncertainty, contact a Volkswagen dealership.

WARNING

Incorrect cleaning can cause damage to the seat belts, the belt anchorages and the belt retractor.

- ❑ Never try to modify or remove the seat belts for cleaning.
- ❑ Never clean the seat belts and their components with chemical agents.
- ❑ Do not use any caustic liquids, solvents or sharp objects.
- ❑ Protect the belt buckles against the ingress of liquids and foreign bodies.
- ❑ Let the cleaned seat belt to dry completely before allowing it to retract.

NOTICE

Incorrect cleaning and care can cause vehicle damage.

❗ Do not use a steam cleaner, brushes or hard sponges etc. under any circumstances.

❗ Have stubborn stains removed by a qualified workshop.

1) Mild soap solution: a maximum of two tablespoons neutral soap diluted in one litre of water.

Accessories, modifications, repairs and renewal of parts

Accessories and replacement parts

Volkswagen recommends that you seek advice from a Volkswagen dealership before purchasing accessories, replacement parts or servicing materials, e.g. if the vehicle is to be retrofitted with accessories or if parts need to be replaced. Volkswagen dealerships can recommend accessories, replacement parts and service fluids suitable for your requirements. They can also provide information regarding official regulations.

Volkswagen recommends that you use only approved Volkswagen accessories and Volkswagen Genuine Parts®. These parts and accessories have been specially tested by Volkswagen for suitability, reliability and safety. Volkswagen dealerships are also qualified to install them correctly.

Although the market is constantly scrutinised, Volkswagen cannot assume responsibility for the reliability, safety and suitability of products Volkswagen has not approved. Volkswagen can therefore assume no responsibility for these parts even if they have been approved by an official testing agency or are covered by an official approval certificate.

Any retrofitted equipment which has a direct effect on the control of the vehicle must be approved by Volkswagen for use in your vehicle and bear the e mark (the European Union's approval symbol). These devices include cruise control systems or an electronically controlled suspension.

Any additional electrical components fitted that do not serve to control the vehicle itself must bear the  mark (manufacturer conformity declaration in the European Union). Such devices include refrigerator boxes, computers and ventilator fans.

WARNING

Incorrectly performed repairs or modifications to your vehicle can impair the effectiveness of the airbags and cause malfunctions, accidents and fatal injury.

❗ Never secure or position objects, e.g. telephone holders, in the deployment zone of the airbags since these objects can cause serious or fatal injuries if the airbags are triggered.

Repairs and technical modifications

Repairs and technical modifications must always be carried out according to Volkswagen specifications⇒  .

Unauthorised modifications to the electronic components or software in the vehicle may cause malfunctions. As the electronic components are linked together in networks, these faults may indirectly affect the operation of other systems. This can seriously impair safety, lead to excessive wear of components, and also invalidate the type approval for the vehicle.

The Volkswagen dealership cannot be held liable for any damage caused by technical modifications and/or work performed incorrectly.

The Volkswagen dealership is not responsible for damage caused by technical modifications and/or work performed incorrectly. Such damage is not covered by the Volkswagen guarantee.

Volkswagen recommends that all repairs and technical modifications be performed by an authorised Volkswagen workshop using Volkswagen Genuine Parts®.

Volkswagen repair information

Volkswagen service information and official Volkswagen repair information can be purchased for a fee.

Customers in Europe, Asia, Australia, Africa, Central and South America: please contact a Volkswagen dealership or qualified workshop or register with the online portal erWin (electronic repair and workshop information):

<https://erwin.volkswagen.de>

erWin is available in numerous languages.

Vehicles with special body equipment or add-on parts

The manufacturers of body equipment and add-on parts must ensure that the body equipment and add-on parts (conversions) adhere to the applicable environmental laws and regulations, particularly the EU directive 2000/53/EC concerning end-of-life vehicles and EU directive 2003/11/EC concerning the restrictions on the marketing and use of certain dangerous substances and preparations.

The vehicle owner should keep all assembly documentation for these conversions, and pass it on to the disassembly company upon vehicle handover if the vehicle is scrapped. This is designed to facilitate environmentally friendly disposal for all vehicles, including converted vehicles.

Windscreen repairs

To function properly, some items of equipment require an electrical or electronic module, which is located on the inside of the windscreen near the interior mirror. If the windscreen has been damaged in the viewing field of the electrical or electronic module, e.g. by stone impact, the windscreen must be replaced. Repairing the crack can lead to malfunctions or faults in the equipment.

After changing the windscreen, the camera and sensors must be set up and calibrated by a qualified workshop.

Impairment or damage to sensors and cameras

Incorrectly performed repairs, structural changes to the vehicle, e.g. lowering the suspension, retrofitted add-on parts or changes to the trim can lead to sensors and cameras being displaced or damaged. This can also be caused by collisions, e.g. when parking, or also even by minor damage, e.g. stone impacts on the windscreen.

Failure to observe this point may impair important functions (driver assist systems) and damage the vehicle.

The area in front of and around the sensors and cameras must not be covered by stickers, additional headlights, trim frames for number plates or similar.

Repairs and structural modifications should therefore be carried out only by a qualified workshop. Volkswagen recommends using a Volkswagen dealership for this purpose.

☒ Repainting and paint touch-ups in the area around the sensors may impair the function of the system in question.

☒ As the Volkswagen badge influences the view of the radar sensor in the front area, drive the vehicle only with the original Volkswagen badge.

Engine and transmission guard

An engine and transmission guard can reduce the risk of damage to the vehicle's underbody and sump, for example when driving over kerbs, drive entrances or unsurfaced roads.

Volkswagen recommends that you have this equipment retrofitted by your Volkswagen dealership.

WARNING

Incorrectly performed repairs and modifications can cause malfunctions and damage to the vehicle and impair the effectiveness of the driver assist systems. This can result in accidents and severe injuries.

☒ Have repairs and modifications to your vehicle carried out only by a qualified workshop.

WARNING

Unsuitable spare parts and accessories, incorrectly carried out work, modifications and repairs can lead to damage to the vehicle and cause accidents and serious injuries.

☒ Volkswagen strongly recommends that you use only approved Volkswagen accessories and Volkswagen Genuine Parts®. These parts and accessories have been specially tested by Volkswagen for suitability, reliability and safety.

☒ Have repairs and modifications to your vehicle carried out only by a qualified workshop. Qualified workshops have the necessary tools, diagnostic equipment, repair information and qualified personnel.

☒ Never fit parts to your vehicle that differ in their design or characteristics from the factory-fitted parts.

☒ Never secure or position objects, e.g. telephone holders, in the deployment zone of the airbags since these objects can cause serious or fatal injuries if the airbags are triggered.

☒ Use only wheel rim/tyre combinations that have been approved by Volkswagen for your vehicle type.

Repairs and faults in the airbag system

Repairs and technical modifications must always be carried out according to Volkswagen specifications⇒  .

Modifications and repairs to the front bumper, doors, front seats, headliner or the bodywork should be carried out only by a qualified workshop. Airbag system components and sensors might be fitted on these vehicle components.

If you work on the airbag system or remove and install parts of the system when performing other repair work, parts of the airbag system may be damaged. The consequence may be that, in the event of an accident, the airbag inflates incorrectly or does not inflate at all.

Regulations must be observed to ensure that the effectiveness of the airbags is not reduced and that removed parts do not cause any injuries or environmental pollution. Qualified workshops are familiar with these regulations.

Any modifications to the vehicle's suspension could prevent the airbag system from working properly during a collision. For example, using wheel rim/tyre combinations that have not been approved by Volkswagen, lowering the suspension or making modifications to the suspension rate including work on the springs, struts and shock absorbers etc., could change the forces that are measured by the airbag sensors and sent to the electronic control unit. Some changes to the suspension could cause the forces measured by the sensors to increase, for example. This can lead to the airbag system being triggered in collision scenarios where it normally would not be triggered if modifications to the suspension had not been made. Other modifications can cause the forces measured by the sensors to decrease, therefore preventing the airbag system from being triggered when it should have been.

 **WARNING**

Incorrect repairs and modifications can cause malfunctions and damage to the vehicle and impair the effectiveness of the airbag system. This can result in accidents and serious or even fatal injuries.

- ☒ Have repairs and modifications to your vehicle carried out only by a qualified workshop.
- ☒ Airbag modules cannot be repaired. They must be replaced.
- ☒ Never install recycled airbag components or components that have been taken from end-of-life vehicles in your vehicle.

 **WARNING**

Modifications to the vehicle's suspension, including the use of unsuitable tyre/rim combinations, can cause the airbag system to function differently and increase the risk of serious or fatal injuries in the event of an accident.

- ☒ Never install components in the suspension system which do not have the same characteristics as the original factory-fitted components.
- ☒ Never use wheel rim/tyre combinations that have not been approved by Volkswagen.

Mobile reception in the vehicle

Electromagnetic radiation

If a mobile phone or two-way radio is used without being connected to the external aerial, the electromagnetic radiation will not be optimally directed to the outside of the vehicle. Increased levels of radiation in the vehicle interior can occur in particular in the event of poor reception, e.g. in rural areas. This can pose a health risk ⇒ ⚠.

With some equipment levels, a suitable mobile phone interface may be used to connect the mobile telephone to the external aerial ⇒ Booklet Infotainment system,. The connection quality is improved and the range is increased.

Using the telephone

Many countries require a hands-free system to be used when using a telephone inside the vehicle, e.g. via a Bluetooth® connection. Secure the mobile telephone to a suitable holder before using it ⇒ ⚠ or stow it securely away in one of the stowage compartments provided, e.g. in the centre console.

Use a compatible mobile phone if the mobile phone interface uses SIM Access Profile (rSAP) technology. If the LTE mobile standard is supported, use a SIM card with LTE data option.

Radio communication

Observe any legal requirements and the manufacturer's owner's manual when using radio communication devices. Two-way radios must be approved if they are to be retrofitted in the vehicle.

Contact your Volkswagen dealership for further information on installing a two-way radio.

WARNING

Mobile telephones which are loosely placed in the vehicle or not properly secured could be flung through the interior and cause injuries during a sudden driving or braking manoeuvre, or in the event of an accident.

☑ Secure a mobile telephone and accessories outside the deployment zone of the airbags, or stow them safely.

WARNING

If mobile telephones or two-way radios that are not connected to an external aerial are used, electromagnetic radiation in the vehicle could exceed limit values and thus be a health hazard for drivers and other vehicle occupants. This also applies to external aerials which have not been correctly installed.

☑ Keep a distance of at least 20 cm between a device's aerial and an active medical implant, e.g. a pacemaker.

☑ Do not carry an operational device close to or directly above an active medical implant, e.g. in a breast pocket.

☒ Switch off the device immediately if you suspect it may be interfering with an active medical implant or any other medical device.

Customer information

Warranty and LongLife mobility guarantee

Volkswagen dealership warranty

Volkswagen dealerships guarantee that all vehicles purchased from them are free of faults.

Volkswagen dealerships provide a warranty that new Volkswagen vehicles are free of faults.

Details of warranty conditions and the warranty periods can be found in your sales contract.

Please ask your Volkswagen dealer for further information.

You are advised that natural wear and damage caused by abnormally rough or improper use, or unauthorised modifications are not covered by this warranty.

If your vehicle breaks down, please contact your nearest available Volkswagen dealership.

Warranty for the paintwork and body

Volkswagen dealerships provide a warranty on the paintwork and body of all vehicles purchased from them.

In addition to the warranty conditions for new Volkswagen vehicles (as detailed in the purchase contract), the Volkswagen dealership guarantees that the body of any vehicles it sells will not be affected by paint defects or corrosion perforation for a specified period:

☒ a three-year warranty on paint defects and

☒ a twelve-year corrosion perforation warranty. Here, corrosion perforation refers to rust forming on the inside (cavity) of the body and causing holes in the sheet metal.

If such damage occurs nevertheless, it will be repaired free of charge for parts and labour by any Volkswagen dealership.

The warranty does not cover the following:

☒ Damage caused by external influence or insufficient care.

☒ Defects on the body or paintwork which are not repaired promptly according to manufacturer specifications.

☒ Corrosion perforation that is directly related to body repairs not being carried out according to manufacturer specifications.

If the body is repaired or painted, your Volkswagen dealer will confirm your warranty against corrosion perforation for the repaired section.

LongLife mobility guarantee

In many European markets, your new vehicle includes the comprehensive LongLife mobility guarantee which will be renewed after every inspection.

Please note that the validity of the Volkswagen LongLife mobility guarantee may differ depending on the country in which the vehicle was sold. Please ask your Volkswagen dealership for further information.

The selling Volkswagen dealership will issue a comprehensive LongLife mobility guarantee for every new vehicle which applies from the time of delivery until the first due inspection. If you purchase your new vehicle directly from Volkswagen AG, Volkswagen AG will issue the LongLife mobility guarantee from the time of delivery until the first due inspection.

Your Volkswagen dealership will extend the LongLife mobility guarantee until the following inspection when the due inspection is carried out by the dealership. The service costs include the entire guarantee package.

The comprehensive LongLife mobility guarantee includes the following services:

If your vehicle can no longer be driven due to a technical defect¹⁾, corresponding assistance will be provided in the case of breakdown or accident. The LongLife mobility guarantee provides with you protection and mobility.

The inspection is not only about car maintenance - it also ensures that your car remains roadworthy and in perfect working order. For this reason, servicing should be carried out regularly in accordance with the manufacturer's specifications.

Your entitlement to the LongLife mobility guarantee is documented in the digital service schedule each time your car is serviced. A full service history shows that your car has been professionally maintained and cared for.

1) A vehicle which can no longer be driven is a vehicle which cannot reach a workshop under its own power.

Data storage and services

Your vehicle is fitted with electronic control units. Some of these are required to make sure your vehicle remains safe while others provide support while driving (driver assist systems). Furthermore, your vehicle is equipped with convenience and Infotainment functions, which are also made possible using electronic control units.

Electronic control units contain data memories which can store information regarding the vehicle status, component load levels, servicing requirements, technical events and faults on a temporary or permanent basis. This information generally documents the status of a component, a module, a system or the environment, e.g.:

- ☐ Operating states of system components, e.g. filling levels, tyre pressure, battery status.
- ☐ Status messages of the vehicle or its individual components, e.g. wheel revolutions or speed, deceleration, lateral acceleration, display of fastened seat belts.
- ☐ Faults or malfunctions in important system components, e.g. lights, brakes.
- ☐ Information on events during which the vehicle sustained damage.
- ☐ System reactions to specific driving situations, e.g. triggering of an airbag, intervention of the stability control systems.

☒ Ambient conditions, e.g. temperature, rain.

As well as performing the actual control functions, these data are also used to detect and rectify faults and help Volkswagen to improve vehicle functions. The majority of these data are temporary and are only processed within the vehicle itself. Only a very small amount of data is stored in the event memories or possibly on the vehicle key.

Reading out the vehicle's event memory

There is a diagnostic interface in the vehicle interior for reading out the event memories (on-board diagnosis) ⇒ .

If you have service work performed on your vehicle, the technical data can be read out of the vehicle together with the vehicle identification number by service employees, e.g. workshops, or third parties such as breakdown services. Service work includes, for example, repairs, maintenance, warranty work or quality assurance measures. The service workshop or third party collects, processes and uses the data. The data document the vehicle's technical status, help in troubleshooting and in improving quality and may be sent to Volkswagen in some cases.

Furthermore, the manufacturer is subject to legal product safety requirements. To make sure it complies with these requirements, the manufacturer requires technical data from the vehicles.

Event memories in the vehicle can be reset by a service workshop as part of repair or service work.

The event memory should be read out and reset only by a qualified workshop. Additional information on the stored data is available from the qualified workshop.

After a fault has been rectified, the information in the memory relating to the fault is deleted. Other memory content is overwritten on an ongoing basis.

Event data recorder

This vehicle is equipped with an event data recorder. The main task of an event data recorder is to record data in particular accident scenarios or accident-like situations, e.g. in the event of airbags being triggered or a collision with an obstacle on the road. These data help in analysis of how a vehicle system behaved in these situations. The event data recorder records data relating to driving dynamics and the restraint system for a short period of 10 seconds or less. This information includes, for example:

- ☒ how various systems in your vehicle have functioned.
- ☒ whether the seat belts of the driver and front passenger were fastened.
- ☒ the extent to which the driver pressed the brake or accelerator.
- ☒ how fast the vehicle was travelling.

These data help to obtain a better understanding of the circumstances in the situations where accidents and injuries have occurred.

Data from driver assist systems are also recorded. In addition to information about whether the systems were switched on or off, available only to a restricted extent or inactive, it is also possible to determine whether these functions steered, accelerated or braked the vehicle in the above-described situations. Depending on the vehicle equipment, these systems include the following:

- ☒ Adaptive Cruise Control (ACC).
- ☒ Lane keeping system (Lane Assist).
- ☒ Park Assist.
- ☒ Park Distance Control.
- ☒ Emergency braking functions (Front Assist).

The data of the event data recorder are recorded only if a particular accident-like situation occurs. No recordings occur under normal driving conditions. Audio or video data from the vehicle interior or vehicle surroundings are not stored. Personal data such as name, gender, age or accident location are also not recorded at any time. However, third parties such as law enforcement agencies can use corresponding means to link the content of the event data recorder with other sources of data and thus establish a reference to persons as part of an accident investigation.

Special equipment, access to the legally prescribed diagnostic interface (on-board diagnosis) and switched-on ignition are required in order to read data out of the event data recorder.

Volkswagen will not access, read out or process data from the event data recorder unless the vehicle owner (or lessee in the case of leasing) grants their permission. Exceptions to this are contractual or legal provisions.

Due to its legal product monitoring obligations, Volkswagen is entitled to use the data for field monitoring and also for research purposes and quality improvements. For research purposes, Volkswagen makes the data available to third parties in anonymous form, in other words without any reference to the individual vehicle, vehicle owner or lessee.

Reprogramming control units

All data for the control of components are stored in the control units. Some convenience functions, such as convenience turn signal, single door unlocking and displays, can be reprogrammed using special workshop equipment. If the convenience functions are reprogrammed, the specifications and descriptions in this owner's manual will no longer match the original functions. Volkswagen recommends having any reprogramming entered into the digital service schedule by a Volkswagen dealership or qualified workshop.

Information about possible reprogramming can be obtained from the Volkswagen dealership.

Convenience and Infotainment functions

Depending on the equipment selected, you can store your own data in the vehicle's Infotainment functions. This includes, for example:

- ☒ Media files for playback of music, films or photos in an Infotainment system.
- ☒ Address book data for use with a hands-free system or navigation system.
- ☒ Entered navigation destinations.
- ☒ Data regarding the use of online services.

These data can be stored locally in the vehicle or located on a device that you have connected to the vehicle, e.g. mobile device, USB stick or MP3 player. If these data are stored in the vehicle, you can

delete them at any time. These data are transmitted to third parties only at your request, in particular in relation to the use of online services and in accordance with your personal settings.

You can store convenience settings (personalisation) in the vehicle and change them at any time. Depending on the equipment in the vehicle, this includes, for example:

- ☑ Seat position settings.
- ☑ Running gear and air conditioning system settings.
- ☑ Customised settings including mirror adjustment or background lighting.

Integration of mobile devices

If your vehicle contains the necessary equipment, you can connect your mobile device or any other mobile end device to your vehicle so that you can control this device via the controls integrated in the vehicle when the corresponding functions are available. For example, images and sounds from the mobile device can be output through the Infotainment system. At the same time, certain information is sent to your mobile device. This includes location data and further general vehicle information, depending on the type of integration. For more details, refer to the information about display of apps in the Infotainment system.

This enables selected apps on the mobile device to be used in the vehicle, e.g. navigation or music player. The mobile device and vehicle do not interact in any other ways than those described here, in particular the device does not actively access vehicle data. The type of further data processing depends on the app provider. The settings that you can make here depend on the app in question and the operating system of your mobile device.

Third-party providers

If your vehicle is equipped with a connection to a mobile network, your vehicle will be able to exchange data with other systems. The vehicle can be connected to a mobile network using a transmitter and receiver unit in the vehicle or using your own mobile device. This mobile network connection enables you to use online functions. This includes online services and apps provided by Volkswagen or other third-party providers.

Manufacturer services

In the case of Volkswagen online services, Volkswagen describes the respective functions in a suitable place, e.g. in a separate service description or on an Internet page, and the associated privacy information is provided. Personal data may be used to perform online services. For this, data are exchanged over a secure connection, e.g. using the designated IT systems of the manufacturer. Any collection, processing and use of personal data that goes beyond the provision of the service takes place exclusively according to legal regulations, contractual agreements or the necessary permission.

You can activate and deactivate the services and functions, some of which charge a fee, and, in some cases, also disable the vehicle's entire data connection. This does not apply to any functions and services required by law, e.g. emergency call systems.

Third-party services

If you are able to use online services provided by a party other than the manufacturer, these services are the sole responsibility of the provider in question and are subject to this provider's privacy policy

and terms and conditions of use. Volkswagen has no influence over the content exchanged in these services.

Please refer to the provider in question for information about the type, scope and purpose of the collection and use of personal data related to third-party services.

 WARNING

Incorrect use of the diagnostic interface can cause malfunctions, which can result in accidents and serious injuries.

- ⓘ Never read out the event memory using the diagnostic interface yourself.
- ⓘ The event memory should be read out via the diagnostic interface only by a qualified workshop. Volkswagen recommends using a Volkswagen dealership for this purpose.



Please note the further information on Volkswagen Car-Net services ⇒ Mobile online services .

Information stickers and plates

Stickers and plates showing important information for vehicle operation are factory-fitted in the engine compartment and on certain vehicle parts.

- ⓘ Never remove stickers and plates or make them unusable or illegible.
- ⓘ If vehicle parts bearing stickers or plates are removed from the vehicle, replacement stickers or plates with the same information must be applied properly to the new parts by the qualified workshop.

Safety certificate

There is a safety certificate on the door pillar of the driver door which states that all necessary safety standards and specifications from the transport safety authorities of the particular country were met at the time of production. The month and year of production and the vehicle identification number may also be listed. Observe notes in the owner's manual.

 WARNING

Handling the vehicle incorrectly will increase the risk of accident and injuries.

- ⓘ Observe legal requirements.
- ⓘ Observe the owner's manual.

 NOTICE

Handling the vehicle incorrectly could lead to the vehicle becoming damaged.

☒ Observe legal requirements.







☒ Carry out servicing work in accordance with the specifications.

Fluids in the air conditioning system

Refrigerant in the air conditioning system

The sticker in the engine compartment provides information about the type and quantity of the refrigerant used in the vehicle's air conditioning system. The sticker is located in the front part of the engine compartment close to the refrigerant filler neck.

Symbol and description:

 Warning: the air conditioning system must be serviced only by qualified personnel.  Type of refrigerant.  Type of lubricating oil.  See workshop information (available only for Volkswagen dealerships).  The air conditioning system must be serviced only by qualified personnel.  Flammable refrigerant.  Ensure correct disposal of all components and never install components removed from end-of-life vehicles or recycled components in the vehicle.

Lubricating oil in the air conditioning system

The air conditioning system contains up to 210 ml of lubricating oil. The exact specification and information about the lubricating oil quantity in the air conditioning system are available from the following website:

<https://erwin.volkswagen.de>

WARNING

The air conditioning system must be serviced only by qualified personnel in order to ensure safe handling of the system.

NOTICE

☒ Never repair the evaporator of the air conditioning system with components from end-of-life vehicles or from recycling sources.

☒ Never replace the evaporator of the air conditioning system with a used evaporator from end-of-life vehicles or from recycling sources.

Radio reception and aerials

The aerials for radio reception can be installed at various locations in the vehicle:

☒ On the inside of the rear window, together with the rear window heating.

☒ On the inside of the rear side windows.

☒ On the inside of the windscreen.

☒ On the roof of the vehicle.

Aerials on the interior of the windows can be identified by thin wires.

NOTICE

Aerials located on the inside of the windows could be damaged by corrosive or acidic substances or if hard objects rub against the window.

☒ Do not affix any stickers over metal wires, e.g. in the area of the rear window.

☒ Never clean the aerials with corrosive or acidic agents.

NOTICE

A retrofitted Infotainment system must be compatible with the aerial amplifier fitted as standard in the vehicle. The aerial amplifier could otherwise be damaged.

Component protection

Some electronic components and control units are fitted with component protection as standard, e.g. the Infotainment system.

The component protection allows legitimate installation and replacement of components and control units by a qualified workshop.

The component protection prevents the factory-supplied components from being operated without restrictions outside the vehicle in the following situations:

☒ Installation in other vehicles, e.g. after theft.

☒ Operation of components outside the vehicle.

When component protection is activated, the message SAFE CP is shown on the instrument cluster display. Go to a qualified workshop.

Go to a qualified workshop if the message Component theft protection: Infotainment system availability currently limited. Please switch on the ignition. is displayed in the Infotainment system and component protection cannot be deactivated.

Information in accordance with the EU Chemicals Regulation REACH

In accordance with the European regulations on chemicals, known as REACH, Volkswagen would like to inform you about the materials that may be found in your vehicle.

You can access this information online using your vehicle identification number ⇒ Technical data :

<https://reachinfo.volkswagen.com>

Declaration of conformity

The individual manufacturer declares herewith that the following products conform, at the time of vehicle production, with the basic requirements and other relevant laws and regulations, including FCC Part 15.19, FCC Part 15.21 and RSS-Gen Issue 1:

Radio-based equipment

- ☑ Electronic immobiliser.
- ☑ Vehicle key.
- ☑ Adaptive Cruise Control (ACC).
- ☑ Area monitoring system (Front Assist) including City Emergency Braking System.
- ☑ Keyless locking and starting system Keyless Access.
- ☑ Blind Spot Monitor including Rear Traffic Alert
- ☑ Traffic Jam Assist.
- ☑ Emergency Assist.

Electrical equipment

- ☑ 12-volt socket.

Recycling and scrapping end-of-life vehicles

Recycling end-of-life vehicles

Volkswagen has already made provision for you to recycle your vehicle in an environmentally responsible manner. The extensive recycling systems operating in many European countries will take back your vehicle at the end of its useful life. Once the vehicle has been recycled, a certificate of destruction will be issued to show that the vehicle has been disposed of correctly.

Return of end-of-life vehicles is free of charge, provided that national legislation is complied with.

Further information on return and recycling of end-of-life vehicles is available from a Volkswagen dealership.

Scrapping

The relevant safety requirements must be observed when the vehicle or its individual components, e.g. from the airbag system and belt tensioners, are scrapped. Qualified workshops are familiar with these regulations.

Information about vehicles with N1 approval (light commercial vehicle)

Please observe the following for vehicles used to transport goods with a maximum permitted weight of up to 3.5 t (N1 approval in Europe):

Variants and number of seats

There are various types of N1 vehicles based on a Volkswagen passenger car. The number of seats may be restricted to two or four.

Vehicles with two seats: there is no floor covering in the rear of the vehicle interior because there is no rear bench seat ⇒  .

Vehicles with four seats: the centre seat on the rear bench seat cannot be used ⇒  .

Transporting children safely

As with vehicles with passenger car approval (M1), approved child restraint systems can be used on the seats ⇒ Safe transport of children .

Towing a trailer

If the vehicle is approved for towing a trailer, observe any local regulations for driving with a trailer and using a towing bracket.

If the vehicle exceeds the gross vehicle weight rating or the rear axle load, do not exceed 80 km/h when towing a trailer. This also applies to countries where higher speeds are permitted. Keep to country-specific speed limits which may be lower for vehicles with trailers than for vehicles without trailers.

The vehicle documents contain details of permitted excess loads. If no excess loads are shown, the vehicle can be driven at 100 km/h, taking account of the laws which apply in different countries.

Technical data

Please refer to the vehicle documentation for technical data.

WARNING

Risk of injury and electric shock from exposed cables.

 Fit out the luggage compartment upon delivery at the latest so that the cables in the rear of the vehicle are covered up when using the vehicle.

WARNING

Risk of serious injuries due to transporting passengers incorrectly.

 Never drive with a person or child sitting in the middle of the rear seat bench.

 An accident could result in serious or fatal injuries due to the lack of safety systems such as seat belts and head restraints.

WARNING

Risk of serious and fatal injuries.

 Do not travel with people in the luggage compartment.

☒ Observe the safety notes and information regarding the luggage compartment and transporting items ⇒ Transporting items .

Information on EU Directive 2014/53/EU

Simplified EU declaration of conformity

Your vehicle is equipped with various radio systems. The manufacturers of these radio systems declare that this equipment complies with Directive 2014/53/EU where required by law.

The complete text of the EU declaration of conformity is available at the following internet address:

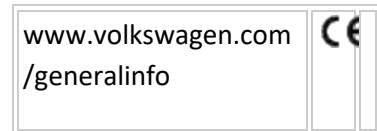

Manufacturers' addresses

All relevant components must bear the manufacturer's address in accordance with 2014/53/EU.

For components that, due to their size or nature, cannot be provided with a sticker, the respective manufacturers' addresses as required by law are listed here:

Radio equipment installed in the vehicle	Manufacturers' addresses
Vehicle key	Hella KGaA Hueck & Co. Rixbecker Strasse 75 59552 Lippstadt GERMANY
	Marquardt GmbH Schloss-Strasse 16 78604 Rietheim-Weilheim GERMANY
	Continental Automotive GmbH Siemensstrasse 12 93055 Regensburg GERMANY
Remote control	Digades GmbH Äussere

Radio equipment installed in the vehicle	Manufacturers' addresses
(auxiliary heater)	Weberstrasse 20 02763 Zittau GERMANY
	Eberspächer Climate Control Systems GmbH & Co. KG Eberspächerstrasse 24 73730 Esslingen GERMANY
Auxiliary heater	Webasto Thermo & Comfort SE Friedrichshafener Strasse 9 82205 Gilching GERMANY
Tyre pressure sensors	Huf Hülsbeck & Fürst GmbH & Co. KG Steeger Strasse 17 42551 Velbert GERMANY

Mapping table

The mapping table is designed to help you link the device name used in a declaration of conformity with the vehicle equipment and terms contained in the vehicle wallet.

Vehicle equipment	Device name according to declaration of conformity		
Vehicle key	FKS09	FS09	FS12A

Vehicle equipment	Device name according to declaration of conformity		
	FS12 A00	FS12 P	FS12 P00
	FS14	FS17 44	FS94
	PKET OUA	RKET OUA	VWT OUA
Remote control (auxiliary heater)	5000 0886	50000886 / Sender STH VW	
	7E0.9 63.51 1.B	7E0.9 63.51 1.C	9019 747B
	EasyS tart R	STH VW - 5000 0884	Teles tart
	9019747B / Remote control of aux heater 868 MHz		
Auxiliary heater	50000864 D208L VW		
(transmitter/receiver unit)	9019510C / Receiver of aux heater 869 MHz		
Instrument cluster,	BNF_ HL	BNF_ LL	eNSF
electronic immobiliser	NSF_ HL	NSF_ LL1	NSF_ LL3
	Instru ment	Instr ume	Instr ume

Vehicle equipment	Device name according to declaration of conformity		
	cluster 1	cluster 2	cluster 3
	EZS-VW-Touareg	2017-02-EU-LF_IC_IM	
	Immobiliser integrated in dashboard module instrument cluster		
Tyre pressure sensors	TSSR E4Dg	TSSS G4G5	
Bluetooth	ALPS UGZZ F-102B	ALPS UGZZ F-202B	HT-5
	MIB2 Entry	MIB2 Main-Unit	
	MIB Global Entry /Standard		
WLAN hotspot	HT-5	MIB2 Main-Unit	
	MIB Global Entry /Standard		

Vehicle equipment	Device name according to declaration of conformity		
Mobile phone interface	HT-5		
Connection to the external aerial	LTE-MBC-EU	UMTS/GSM-MMC	
Garage door opener	ADHL5D	EHL2	
		EHL2 (Euro HomeLink 2)	
Keyless Access	Kessy MQB-A	Kessy MQB-A SG	Kessy MQB-B B
	Kessy MQB-B H	Kessy MQB-B SG	Kessy PPQ35 SG
	Kessy PQ35	Kessy PQ35 GP	MQB-A
	MQB-B B	MQB-B H	PQ35 Kessy
	PQ35 GP	PKET OUA (868 MHz)	RKET OUA
Radar sensors for assist system	ARS4-B	BSD 3.0	LCA 2.0A
	LRR3	LRR3 Mast	LRR4

Vehicle equipment	Device name according to declaration of conformity		
s		er & Slave	
	LRR4R	MRR e14F CR	MRR evo14F
	MRR 1Plus	MRR 1Rea r	R3TR
	RS4		
Car-Net Security & Service	TUV MO2I U-E		
Car-Net e-Remote	HT-6	HT-6d	HT-6e
Central control unit	BC-Module	BCM PQ26 ROW (502N1xFOx)	
	BCM evo	BCM 2	BCM 2R
	BR11	RXI-35-433-DC	5WK 50254
Infotainment system	A109	A486 / A449 / A493 / 183	
	A473 / A476 /	A475 / A754	A580 / A270

Vehicle equipment	Device name according to declaration of conformity		
	A750		
	L40V W2	L53V W2	L56V W2
	L62V W2	L69V W2	L77V W2
	L73V W2	MIB Global Entry /Standard	
	MIB Standard 2 – PQ +/NAV with BT and WLAN		
	MIB Standard 2 – ZR +/Nav with BT and WLAN		
	MIB Standard 2 – ZR +/Nav with BT		
	MIB Standard 2 – PQ +/NAV with BT		
	MIB2 Entry	MIB2 Main- Unit	MIB 2 Standard PQ
	MIB2 STD	MIB 2 Standard ZR	MMI 3G
	MMI 3G R U		

Vehicle equipment	Device name according to declaration of conformity		
Aerial	1K8 035 552	1K8. 035.5 52.C	1K8 035 552 F
	1S0.0 35.57 7.A	2GA. 035.5 77.B	2G0. 035.5 77.A
	3C0.0 35.50 7.AA	3C0. 035.5 07.N	3C0. 035.5 07.P
	3789. 01		
	4G5 035 225 B	4G8 035 225 B	4G9 035 225 B
	5L0.0 35.50 1.A	5Q0. 035.5 07.A	5Q0. 035.5 07.B
	5Q0. 035.5 07.C	5Q0. 035.5 07.P	5Q0. 035.5 07.Q
	5Q0. 035.5 07.S	6C0. 035.5 01	6C0. 035.5 01.A
	6C0.0 35.50 1.C	6C0. 035.5 01.D	6C0. 035.5 01.G
	6C0.0 35.50 1.J	6C0. 035.5 01.N	6R0. 035.5 01
	6R0.0 35.50	6R0. 035.5	6R0. 035.5

Vehicle equipment	Device name according to declaration of conformity		
	1.A	01.C	01.D
	6R0.0 35.50 1.F	6R0. 035.5 01.L	7C0. 035.5 01
	7C0.0 35.50 1.C	7C0. 035.5 01.D	7H0. 035.5 07.E
	7N0. 035.5 07.A	7N0. 035.5 07.B	760.0 35.57 7.T
	920 336 003	920 336 005	920 336 006
	920 336 007	920 336 008	920 336 010
	920 336 011	920 336 012	920 336 013
	920 336 014	920 417 007	920 417 010
	920 481 002	920 481 003	920 481 004
	920 481 012	920 481 013	920 481 014
Aerial amplifier	2GA. 035.5 77	2GA. 035.5 77.A	2GA. 035.5 77.B

Vehicle equipment	Device name according to declaration of conformity		
	3G5.0 35.57 7	3G5. 035.5 77.A	3G5. 035.5 77.B
	3G5.0 35.57 7.G	3G5. 035.5 77.H	3G5. 035.5 77.J
	3G5.0 35.57 7.K	3G8. 035.5 77	3G8. 035.5 77.A
	3G8.0 35.57 7.B	3G8. 035.5 77.E	3G8. 035.5 77.F
	3G8.0 35.57 7.G	3G8. 035.5 77.H	3G8. 035.5 77.J
	3G8.0 35.57 7.K	3G9. 035.5 77	3G9. 035.5 77.A
	3G9.0 35.57 7.B	3G9. 035.5 77.G	3G9. 035.5 77.H
	3G9.0 35.57 7.J	3G9. 035.5 77.K	4S0.0 35.22 5.A
	4S0.0 35.22 5.D	5C3. 035.5 52	5C3. 035.5 52.A
	5C3.0 35.55 2.B	5C5. 035.5 52	5C5. 035.5 52.A
	5C5.0 35.55	5E5.0 35.57	5E5.0 35.57

Vehicle equipment	Device name according to declaration of conformity		
		2.B	7.A
	5F4.0 35.22 5	5F4.0 35.22 5.A	5F4.0 35.22 5.B
	5G6.0 35.57 7	5G6. 035.5 77.A	5G6. 035.5 77.B
	5G6.0 35.57 7.E	5G6. 035.5 77.F	5G9. 035.5 77
	5G9.0 35.57 7.A	5G9. 035.5 77.B	5G9. 035.5 77.G
	5G9.0 35.57 7.H	5G9. 035.5 77.J	5G9. 035.5 77.K
	5NA. 035.5 77	5NA. 035.5 77.A	5NA. 035.5 77.B
	5NA. 035.5 77.E	5NA. 035.5 77.F	5TA. 035.5 77
	5TA.0 35.57 7.A	5TA. 035.5 77.B	510.0 35.57 7
	510,0 35,57 7.A	510,0 35,57 7.B	575.0 35.22 5
	575.0 35.22 5.A	575.0 35.22 5.B	6C0. 035.5 77

Vehicle equipment	Device name according to declaration of conformity		
	6C0.0 35.50 1	6C0. 035.5 01.A	6C0. 035.5 01.C
	6C0.0 35.50 1.D	6C0. 035.5 01.G	6C0. 035.5 01.J
	6C0.0 35.50 1.N	6V6. 035.5 77.A	6V6. 035.5 77.B
	6V9.0 35.57 7.A	6V9. 035.5 77.B	7C0. 035.5 01
	7C0.0 35.50 1.C	7C0. 035.5 01.D	7N0. 035.5 52.K
	7N0. 035.5 52.J	7N0. 035.5 52.Q	7P6. 035.5 52
	7P6.0 35.55 2.A	7P6.0 35.55 2.M	920 105 105
	920 105 110	920 211 072	920 211 172
	920 211 201	920 211 202	920 213 172
	920 286 002	920 286 005	920 286 009
	920 286	920 286	920 286

Vehicle equipm ent	Device name according to declaration of conformity		
	010	011	012
	920 286 013	920 286 015	920 286 313
	920 286 323	920 286 343	920 286 351
	920 286 352	920 286 353	920 286 354
	920 286 362	920 286 382	920 286 383
	920 286 385	920 286 386	920 304 022
	920 301 022	920 301 030	920 301 031
	920 355 001	920 437 003	920 437 023
	920 437 035	920 437 303	920 437 323
	920 437 335	920 460 003	920 460 009
	920 460 018	920 460 025	920 460 028

Vehicle equipment	Device name according to declaration of conformity		
	920 460 042	920 460 047	920 460 069
	920 460 303	920 460 318	920 460 325
	920 460 328	920 460 342	920 460 347
	920 460 369	920 461 001	920 461 002
	920 461 003	920 461 004	920 461 005
	920 554 001	920 554 002	920 554 003
	920 554 004		

Frequency bands, transmit power

Radio equipment a)	Frequency band	Max. transmit power
Vehicle key	433.0 5– 434.7 8 MHz	10 mW (ERP)
	433.0 5– 434.7	10 mW

Radio equipment a)	Frequency band	Max. transmit power
	9 MHz	
	868.0 – 868.6 MHz	25 mW
	434.4 – 436.4 MHz	32 μ W
Applies to:	all Volkswagen passenger car models.	
Remote control (auxiliary heater)	868.7 – 869.2 MHz (869.0 MHz)	0.24 mW, / - 6.3 dBm e.r.p.
	Applies to: MQB 37, MQB 48 \Rightarrow Key to models .	
	868.0 – 868.6 MHz (868.3 MHz)	3.1 mW, / 4.8 dBm e.r.p.
	Applies to: Sharan, Touareg.	
Auxiliary heater (transmitter/receiver unit)	868.0 – 868.6 MHz (868.3 MHz)	23.5 mW, / 13.7 dBm e.r.p.

Radio equipment a)	Frequency band	Max. transmit power
	Applies to: Sharan.	
	868.7 – 869.2 MHz (869.0 MHz)	23.5 mW, / 13.7 dBm e.r.p.
	Applies to: MQB 37, MQB 48 → Key to models .	
	868.0 – 868.6 MHz (868.5 25 MHz)	10 mW ERP
	Applies to: Touareg.	
Tyre pressure sensors	433.9 2 MHz	10 mW
	Applies to: Volkswagen models with Tyre Pressure Monitoring System.	
Instrument cluster	125 kHz	40 dBμA/m
	Applies to: All Volkswagen models.	
Electronic	125	3.728

Radio equipment a)	Frequency band	Max. transmit power
immobiliser	kHz +/- 10 kHz	W
Applies to:	All Volkswagen models.	
Bluetooth	2,402 – 2,480 MHz	0.0501 1 W
	2,400 – 2,483.5 MHz	10 dBm
	2,408 – 2,480 MHz	10 dBm
Applies to:	Volkswagen models with mobile phone interface.	
WLAN hotspot	2,412 – 2,462 MHz	0.1 W
	2,412 – 2,472 MHz	0.0501 1 W
	2,412 – 2,480 MHz	20 dBm / 0.1W
	2,400 –	10 dBm

Radio equipment a)	Frequency band	Max. transmit power
	2,483.5 MHz	
	2,402 – 2,442 MHz	20 dBm / 0.1W
	2,408 – 2,480 MHz	4.1 dBm
Applies to:	Volkswagen models with WLAN hotspot.	
Garage door opener	868.00 – 868.600 MHz	25 mW e.r.p.
	868.700 – 869.200 MHz	25 mW e.r.p.
	433.05 – 434.79 MHz	10 mW e.r.p.
	40,660 – 40,700 MHz	10 mW e.r.p.
	26,957 – 27,293 MHz	10 mW e.r.p.
Applies to:	Touareg.	

Radio equipment a)	Frequency band	Max. transmit power
Keyless Access	125 kHz	22.7 dB μ A/m
	Applies to: PQ 35, MQB 37, MQB 48⇒ Key to models .	
	434.4 2 MHz	32 μ W
	Applies to: MQB 37, MQB 48⇒ Key to models .	
	868,000–868,600 MHz	25 mW
Applies to: Touareg.		
Central control unit	21.13 – 22.75 kHz	34.2 dB μ A/m @ 10 m
	Applies to: Touareg.	
Radar sensors for assist systems (on front)	76 GHz–77 GHz	28.2 dBm
	Applies to: all Golf and Passat models, Sharan, Touran, Jetta, Arteon.	

Radio equipment a)	Frequ ency band	Max. tr ansmit power
	76 GHz– 77 GHz	3.16 W (35 dBm RMS EIRP)
	Applies to: Polo, T-Roc, Tiguan.	
	76 GHz– 77 GHz	27.7 dB m
	Applies to: Touareg.	
Radar sensor for assist systems (on sides)	77 GHz– 81 GHz	23.38 d Bm
Applies to:	MQB 37, MQB 48⇒ Key to models .	
Radar sensor for assist systems (rear)	24.05 – 24.25 GHz	20 dbmW
Applies to:	all Golf and Passat models, Sharan, Touran, Jetta, Arteon, Touareg, Polo, Beetle, T-Roc.	
Mobile phone	GSM 8 50: 824–	33 dBm/2

Radio equipment a)	Frequency band	Max. transmit power
interface	849 MHz	W
	GSM 900: 880–915 MHz	33 dBm/2 W
	GSM 1800: 1,710 – 1,785 MHz	30 dBm/1 W
	GSM 1900: 1,850 – 1,910 MHz	30 dBm/1 W
	WCDMA FDDI: 1,920 – 1,980 MHz	24 dBm/0.25 W
	WCDMA FDDV: 824–849 MHz	24 dBm/0.25 W
	Applies to:	vehicles with Premium mobile phone interface.
Car-Net	GSM 9	33 dBm

Radio equipment a)	Frequency band	Max. transmit power
Security & Service	00 (880.2 – 959.8 MHz)	(2.002 W)
	GSM 1800 (1,710.2 – 1,879.8 MHz)	30 dBm (1.002 W)
	UMTS B1 (1,920 – 2,170 MHz)	24 dBm (0.25 W)
	UMTS B8 (880–960 MHz) GPS (1,575.42 MHz)	24 dBm (0.25 W)
Applies to:	Arteon, e-Golf, Golf, Golf GTE, Golf Estate, Passat, Passat GTE, Passat Estate, Passat Estate GTE, Tiguan.	
Car-Net e-Remote	GSM 850 (824–849	33 dBm

Radio equipment a)	Frequency band	Max. transmit power
	MHz)	
	GSM 900 (880–915 MHz)	33 dBm
	GSM 1800 (1,710 – 1,785 MHz)	30 dBm
	GSM 1900 (1,850 – 1,910 MHz)	30 dBm
	EGPRS 850 (824–849 MHz)	27 dBm
	EGPRS 900 (880–915 MHz)	27 dBm
	EGPRS 1800 (1,710 – 1,785 MHz)	26 dBm
	EGPRS 1900 (1,850	26 dBm

Radio equipment a)	Frequency band	Max. transmit power
	– 1,910 MHz)	
	UMTS I (1,920 – 1,980 MHz)	24 dBm
	UMTS II (1,850 – 1,910 MHz)	24 dBm
	UMTS III (IX) (1,710 – 1,785 MHz)	24 dBm
	UMTS IV (1,710 – 1,755 MHz)	24 dBm
	UMTS V (VI) (824–849 MHz)	24 dBm
	UMTS VIII (880–915 MHz)	24 dBm

Radio equipment a)	Frequency band	Max. transmit power
Applies to:	all electric and hybrid vehicles with e-Remote, except e-up!	
Car-Net e-Remote	GSM 900: 880–915 MHz	33 dBm/2 W
	GSM 1800: 1,710 – 1,785 MHz	30 dBm/1 W
	WCDMA FDD: 1,920 – 1,980 MHz/	24 dBm/0.25 W
	GPS (1.57542 GHz)	
Applies to:	e-up!, e-load up!	

Key to models

Key to vehicle model groups, where not listed separately in the table:

MQB 37 = e-Golf, Golf, Golf GTE, Golf GTD, Golf GTI, Golf Sportsvan/SV, Golf Estate, Jetta, Jetta Hybrid, R Golf, Tiguan, Touran, T-Roc.

MQB 48 = Arteon, Passat, Passat Alltrack, Passat GTE, Passat Estate, Passat Estate Alltrack, Passat Estate GTE.

PQ 35 = Beetle, Beetle Cabriolet, Scirocco, Sharan.

a) In certain European countries, the activation of or permission to use radio technology may be restricted, not possible, or possible only when additional requirements have been fulfilled.

Technical data

Notes on technical data

Unless otherwise indicated or separately listed, the technical data apply to the basic model. The values may differ if additional equipment is fitted, for different model versions and for special vehicles and in the case of country-specific vehicle specifications. All data in the official vehicle documents take precedence over these data.





Engine

The vehicle data sticker and the official vehicle documents show which engine is installed in your vehicle.

Weight

The values for the kerb weight in the following tables apply for the road-ready vehicle with driver (75 kg), service fluids including fuel tank carrying 90% of its capacity and, where applicable, tools and spare tyre ⇒ . Additional equipment and retrofitted accessories increase the stated kerb weight and reduce the maximum permitted load accordingly.

The load comprises the weights of the following:

-  Passengers.
-  All luggage.
-  Roof load including the base carrier bars or roof bars and the load carrier system
-  Drawbar load when towing a trailer.

Performance figures

In certain vehicles with heavy duty running gear, the engine could be governed to provide a maximum speed of 210 km/h.

The performance figures were measured without equipment which may negatively influence performance, such as a roof carrier or mudflaps.

Gross combination weight

The specified gross combination weights are applicable only for altitudes up to 1,000 m above sea level. The maximum gross combination weight must be reduced by approximately 10% for every further started 1,000 m in altitude.

Notes on the tables

Gearbox abbreviations: MG = manual gearbox, AG = automatic gearbox, DSG® = DSG® dual clutch gearbox. MG6 = 6-speed manual gearbox.



Exceeding the maximum permissible weights, payload, dimensions, vehicle speeds and axle weight ratings could cause damage to the vehicle, accidents and serious injuries.

❑ Do not exceed the permitted weights, gross combination weights, loads, dimensions and maximum speeds.

❑ The actual axle loads must never exceed the gross axle weight ratings.

❑ The payload and the distribution of the load in the vehicle have an effect on the handling and braking distance of the vehicle. Adjust your speed accordingly.

! NOTICE

The load should be distributed as evenly as possible in the vehicle. When transporting heavy objects in the luggage compartment, they should be placed either in front of or over the rear axle in order to minimise the effect on the vehicle's handling.

! NOTICE

Observe the instructions and information for vehicles with an N1 approval ⇒ Information about vehicles with N1 approval (light commercial vehicle) .

Vehicle data

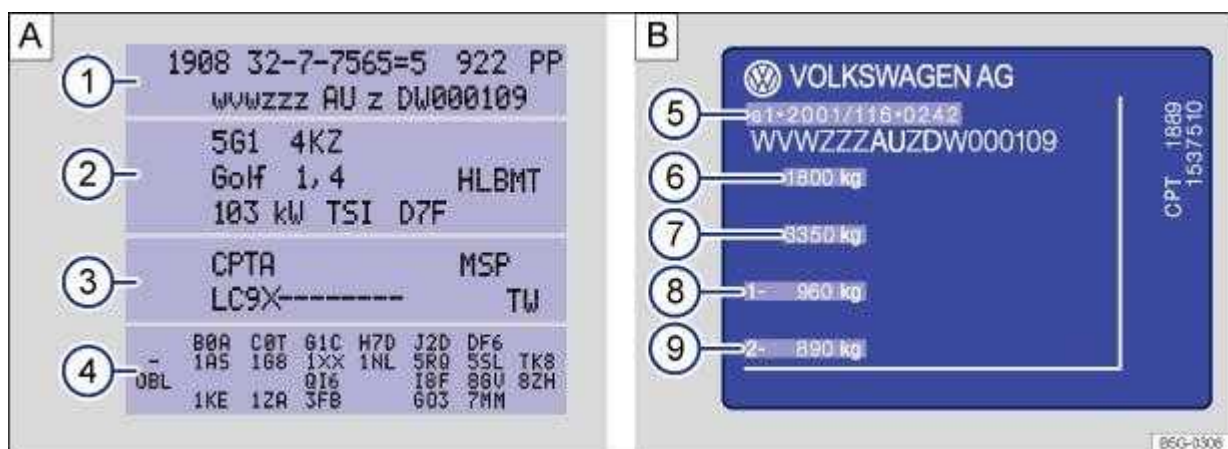

Fig. 213 : vehicle data sticker: the example shows a vehicle with engine code CPTA (3) : type plate.



Fig. 214 Vehicle identification number.

Vehicle data sticker

The vehicle data sticker ⇒ Fig. 213 **A** is located on the cover of the owner's manual and under the rear luggage compartment trim on the luggage compartment wall. It contains the following data:

- ① Vehicle identification number (chassis number)
- ② Vehicle type, engine power, gearbox type
- ③ Engine and gearbox codes, paint number, interior equipment. In the example, the engine code is CPTA ⇒ Fig. 213 **A**.
- ④ Additional equipment, PR numbers

Type plate

The type plate ⇒ Fig. 213 **B** can be seen on the lower part of the door pillar when the driver door is open. Vehicles for certain export countries do not have a type plate.

The type plate contains the following data:

- ⑤ Approval
- ⑥ Gross vehicle weight rating
- ⑦ Gross combination weight rating (vehicle plus trailer)
- ⑧ Gross front axle weight rating
- ⑨ Gross rear axle weight rating

Vehicle identification number (VIN)

The vehicle identification number can be read from outside the vehicle through a viewer in the windscreen ⇒ Fig. 214 (arrow). The viewer is located in the lower corner of the windscreen. The vehicle identification number is also stamped on the right-hand water drainage channel. The water drainage channel is located between the suspension turret and wing. Open the bonnet **▲** to gain access to the vehicle identification number ⇒ In the engine compartment .

The vehicle identification number can be displayed in the Infotainment system using the **CAR** button and the  and Service function buttons ⇒ Infotainment system controls and displays .

Vehicle data

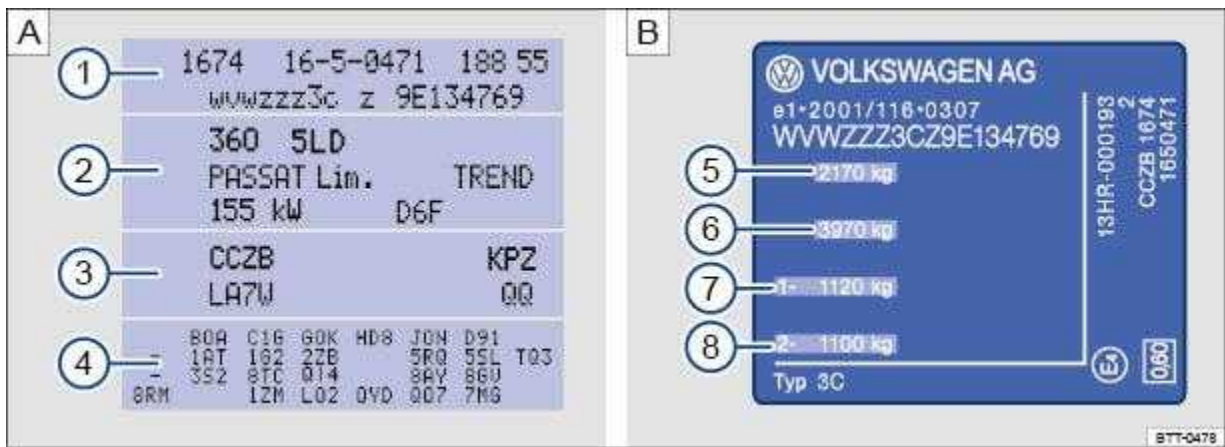

Fig. 215 : vehicle data sticker: example shows a vehicle with engine code CCZB (3) : type plate.

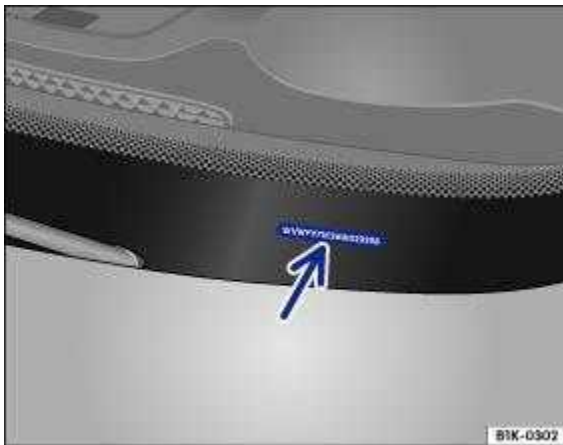

Fig. 216 Vehicle identification number.

Vehicle data sticker

The vehicle data sticker ⇒ Fig. 215 **A** is located on the cover of the owner's manual and under the rear luggage compartment trim on the luggage compartment wall. It contains the following data:

- ① Vehicle identification number (chassis number)
- ② Vehicle type, engine power, gearbox type
- ③ Engine and gearbox codes, paint number, interior equipment. In the example, the engine code is CCZB ⇒ Fig. 215 **A**.
- ④ Additional equipment, PR numbers

Type plate

The type plate ⇒ Fig. 215 **B** can be seen on the lower part of the door pillar when the driver door is open. Vehicles for certain export countries do not have a type plate.

The type plate contains the following data:

- ⑤ Gross vehicle weight rating

⑥ Gross combination weight rating (vehicle plus trailer)

⑦ Gross front axle weight rating

⑧ Gross rear axle weight rating

Vehicle identification number (VIN)

The vehicle identification number can be read from outside the vehicle through a viewer in the windscreen ⇒ Fig. 216 (arrow). The viewer is located in the lower corner of the windscreen. The vehicle identification number is also stamped on the right-hand water drainage channel. The water drainage channel is located between the suspension turret and wing. Open the bonnet  to gain access to the vehicle identification number ⇒ In the engine compartment .

The vehicle identification number can be displayed in the Infotainment system using the **CAR** button and the  and Service function buttons ⇒ Infotainment system controls and displays .

Dimensions

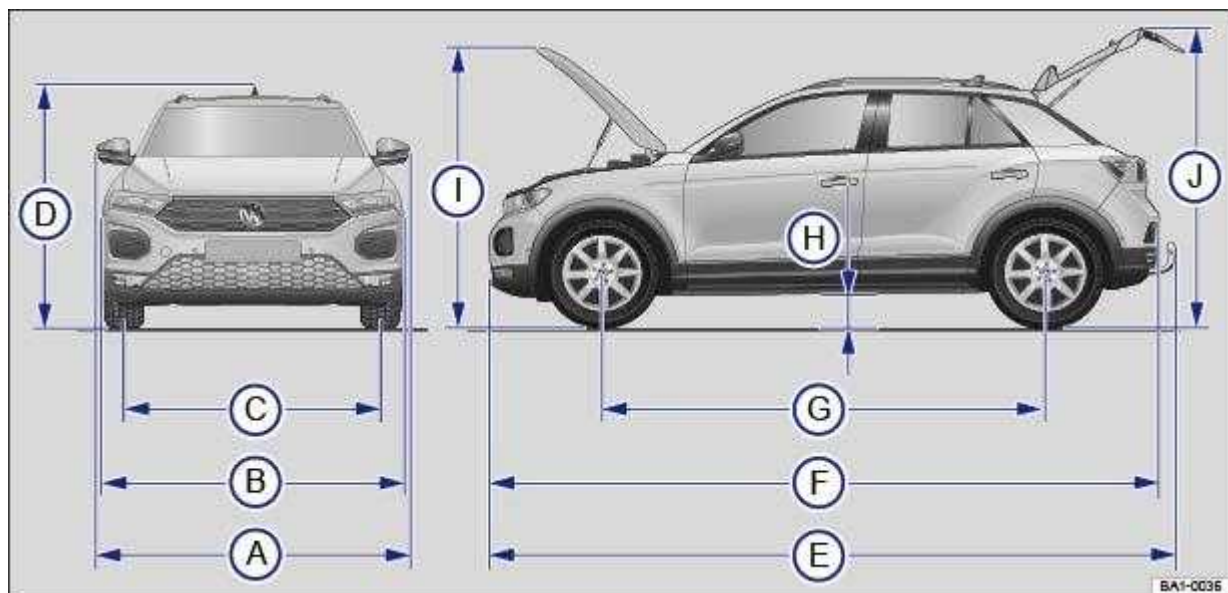

Fig. 217 Illustration: dimensions.

The data in the table apply to the German basic model with the basic specification.

NOTICE

Always take care when driving into parking spaces with high kerbs or fixed boundaries. Objects that protrude from the ground can damage the bumper and other components when parking the vehicle.

